

PCT

WORLD INTELLECTUAL PROPERTY ORGANIZATION
International Bureau

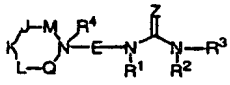

INTERNATIONAL APPLICATION PUBLISHED UNDER THE PATENT COOPERATION TREATY (PCT)

<p>(51) International Patent Classification 7 : A61K 31/445, C07D 211/32, 211/52, 211/58, 211/62, 211/66, 211/76, 221/20, 401/04</p>	<p>A1</p>	<p>(11) International Publication Number: WO 00/35451 (43) International Publication Date: 22 June 2000 (22.06.00)</p>
<p>(21) International Application Number: PCT/US99/30332 (22) International Filing Date: 17 December 1999 (17.12.99) (30) Priority Data: 60/112,717 18 December 1998 (18.12.98) US 60/161,243 22 October 1999 (22.10.99) US (71) Applicant: DU PONT PHARMACEUTICALS COMPANY [US/US]; Chestnut Run Plaza, 974 Centre Road, Wilming- ton, DE 19807 (US). (72) Inventors: KO, Soo, S.; 7 Aston Circle, Hockessin, DE 19707 (US). DELUCCA, George, V.; 2703 Marklyn Drive, Wilmington, DE 19810 (US). DUNCIA, John, V.; 4 Markham Court, Hockessin, DE 19707 (US). SANTELLA, Joseph, B., III; 250 Lewis Road, Springfield, PA 19064 (US). WACKER, Dean, A.; 9 Balmora Drive, Chadds Ford, PA 19317 (US). WATSON, Paul, S.; 223 East Union Drive, Middletown, DE 19709 (US). VARNES, Jeffrey, G.; Apartment 2C, 602 Red Fox Lane, Newark, DE 19711 (US). (74) Agent: VANATTEN, Mary, K.; Du Pont Pharmaceuticals Company, Legal Patent Records Center, 1007 Market Street, Wilmington, DE 19898 (US).</p>	<p>(81) Designated States: AL, AU, BR, CA, CN, CZ, EE, HU, IL, IN, JP, KR, LT, LV, MK, MX, NO, NZ, PL, RO, SG, SI, SK, TR, UA, VN, ZA, Eurasian patent (AM, AZ, BY, KG, KZ, MD, RU, TJ, TM), European patent (AT, BE, CH, CY, DE, DK, ES, FI, FR, GB, GR, IE, IT, LU, MC, NL, PT, SE). Published <i>With international search report.</i></p>	
<p>(54) Title: N-UREIDOALKYL-PIPERIDINES AS MODULATORS OF CHEMOKINE RECEPTOR ACTIVITY</p>		
<p style="text-align: center;"> (I)</p>		
<p>(57) Abstract The present application describes modulators of CCR3 of formula (I), or pharmaceutically acceptable salt forms thereof, useful for the prevention of asthma and other allergic diseases.</p>		

FOR THE PURPOSES OF INFORMATION ONLY

Codes used to identify States party to the PCT on the front pages of pamphlets publishing international applications under the PCT.

AL	Albania	ES	Spain	LS	Lesotho	SI	Slovenia
AM	Armenia	FI	Finland	LT	Lithuania	SK	Slovakia
AT	Austria	FR	France	LU	Luxembourg	SN	Senegal
AU	Australia	GA	Gabon	LV	Latvia	SZ	Swaziland
AZ	Azerbaijan	GB	United Kingdom	MC	Monaco	TD	Chad
BA	Bosnia and Herzegovina	GE	Georgia	MD	Republic of Moldova	TG	Togo
BB	Barbados	GH	Ghana	MG	Madagascar	TJ	Tajikistan
BE	Belgium	GN	Guinea	MK	The former Yugoslav Republic of Macedonia	TM	Turkmenistan
BF	Burkina Faso	GR	Greece	ML	Mali	TR	Turkey
BG	Bulgaria	HU	Hungary	MN	Mongolia	TT	Trinidad and Tobago
BJ	Benin	IE	Ireland	MR	Mauritania	UA	Ukraine
BR	Brazil	IL	Israel	MW	Malawi	UG	Uganda
BY	Belarus	IS	Iceland	MX	Mexico	US	United States of America
CA	Canada	IT	Italy	NE	Niger	UZ	Uzbekistan
CF	Central African Republic	JP	Japan	NL	Netherlands	VN	Viet Nam
CG	Congo	KE	Kenya	NO	Norway	YU	Yugoslavia
CH	Switzerland	KG	Kyrgyzstan	NZ	New Zealand	ZW	Zimbabwe
CI	Côte d'Ivoire	KP	Democratic People's Republic of Korea	PL	Poland		
CM	Cameroon	KR	Republic of Korea	PT	Portugal		
CN	China	KZ	Kazakstan	RO	Romania		
CU	Cuba	LC	Saint Lucia	RU	Russian Federation		
CZ	Czech Republic	LI	Liechtenstein	SD	Sudan		
DE	Germany	LK	Sri Lanka	SE	Sweden		
DK	Denmark	LR	Liberia	SG	Singapore		
EE	Estonia						

TITLEN-UREIDOALKYL-PIPERIDINES AS MODULATORS OF CHEMOKINE
RECEPTOR ACTIVITY

5

FIELD OF THE INVENTION

This invention relates generally to modulators of chemokine receptor activity, pharmaceutical compositions containing the same, and methods of using the same as agents for treatment and prevention of inflammatory diseases such as asthma and allergic diseases, as well as autoimmune pathologies such as rheumatoid arthritis and atherosclerosis.

10

BACKGROUND OF THE INVENTION

15

Chemokines are chemotactic cytokines, of molecular weight 6-15 kDa, that are released by a wide variety of cells to attract and activate, among other cell types, macrophages, T and B lymphocytes, eosinophils, basophils and neutrophils (reviewed in Luster, New Eng. J Med., 338, 436-445 (1998) and Rollins, Blood, 90, 909-928 (1997)). There are two major classes of chemokines, CXC and CC, depending on whether the first two cysteines in the amino acid sequence are separated by a single amino acid (CXC) or are adjacent (CC). The CXC chemokines, such as interleukin-8 (IL-8), neutrophil-activating protein-2 (NAP-2) and melanoma growth stimulatory activity protein (MGSA) are chemotactic primarily for neutrophils and T lymphocytes, whereas the CC chemokines, such as RANTES, MIP-1 α , MIP-1 β , the monocyte chemotactic proteins (MCP-1, MCP-2, MCP-3, MCP-4, and MCP-5) and the eotaxins (-1, -2, and -3) are chemotactic for, among other cell types, macrophages, T lymphocytes, eosinophils, dendritic cells, and basophils. There also exist the chemokines lymphotactin-1, lymphotactin-2 (both C chemokines), and fractalkine (a CXXXC chemokine) that do not fall into either of the major chemokine subfamilies.

20

25

30

35

The chemokines bind to specific cell-surface receptors belonging to the family of G-protein-coupled seven-transmembrane-domain proteins (reviewed in Horuk, Trends Pharm. Sci., 15, 159-165 (1994)) which are termed

5 "chemokine receptors." On binding their cognate ligands, chemokine receptors transduce an intracellular signal through the associated trimeric G proteins, resulting in, among other responses, a rapid increase in intracellular calcium concentration, changes in cell shape, increased

10 expression of cellular adhesion molecules, degranulation, and promotion of cell migration. There are at least ten human chemokine receptors that bind or respond to CC chemokines with the following characteristic patterns: CCR-1 (or "CKR-1" or "CC-CKR-1") [MIP-1 α , MCP-3, MCP-4, RANTES]

15 (Ben-Barruch, et al., Cell, 72, 415-425 (1993), Luster, New Eng. J. Med., 338, 436-445 (1998)); CCR-2A and CCR-2B (or "CKR-2A"/"CKR-2B" or "CC-CKR-2A"/"CC-CKR-2B") [MCP-1, MCP-2, MCP-3, MCP-4, MCP-5] (Charo et al., Proc. Natl. Acad. Sci. USA, 91, 2752-2756 (1994), Luster, New Eng. J. Med.,

20 338, 436-445 (1998)); CCR-3 (or "CKR-3" or "CC-CKR-3") [eotaxin-1, eotaxin-2, RANTES, MCP-3, MCP-4] (Combadiere, et al., J. Biol. Chem., 270, 16491-16494 (1995), Luster, New Eng. J. Med., 338, 436-445 (1998)); CCR-4 (or "CKR-4" or "CC-CKR-4") [TARC, MIP-1 α , RANTES, MCP-1] (Power et al.,

25 J. Biol. Chem., 270, 19495-19500 (1995), Luster, New Eng. J. Med., 338, 436-445 (1998)); CCR-5 (or "CKR-5" OR "CC-CKR-5") [MIP-1 α , RANTES, MIP-1 β] (Sanson, et al., Biochemistry, 35, 3362-3367 (1996)); CCR-6 (or "CKR-6" or "CC-CKR-6") [LARC] (Baba et al., J. Biol. Chem., 272,

30 14893-14898 (1997)); CCR-7 (or "CKR-7" or "CC-CKR-7") [ELC] (Yoshie et al., J. Leukoc. Biol. 62, 634-644 (1997)); CCR-8 (or "CKR-8" or "CC-CKR-8") [I-309, TARC, MIP-1 β] (Napolitano et al., J. Immunol., 157, 2759-2763 (1996), Bernardini et al., Eur. J. Immunol., 28, 582-588 (1998));

35 and CCR-10 (or "CKR-10" or "CC-CKR-10") [MCP-1, MCP-3] (Bonini et al., DNA and Cell Biol., 16, 1249-1256 (1997)).

In addition to the mammalian chemokine receptors, mammalian cytomegaloviruses, herpesviruses and poxviruses have been shown to express, in infected cells, proteins with the binding properties of chemokine receptors
5 (reviewed by Wells and Schwartz, Curr. Opin. Biotech., 8, 741-748 (1997)). Human CC chemokines, such as RANTES and MCP-3, can cause rapid mobilization of calcium via these virally encoded receptors. Receptor expression may be permissive for infection by allowing for the subversion of
10 normal immune system surveillance and response to infection. Additionally, human chemokine receptors, such as CXCR4, CCR2, CCR3, CCR5 and CCR8, can act as co-receptors for the infection of mammalian cells by microbes as with, for example, the human immunodeficiency viruses
15 (HIV).

Chemokine receptors have been implicated as being important mediators of inflammatory, infectious, and immunoregulatory disorders and diseases, including asthma and allergic diseases, as well as autoimmune pathologies
20 such as rheumatoid arthritis and atherosclerosis. For example, the chemokine receptor CCR-3 plays a pivotal role in attracting eosinophils to sites of allergic inflammation and in subsequently activating these cells. The chemokine ligands for CCR-3 induce a rapid increase in intracellular
25 calcium concentration, increased expression of cellular adhesion molecules, cellular degranulation, and the promotion of eosinophil migration. Accordingly, agents which modulate chemokine receptors would be useful in such disorders and diseases. In addition, agents which modulate
30 chemokine receptors would also be useful in infectious diseases such as by blocking infection of CCR3 expressing cells by HIV or in preventing the manipulation of immune cellular responses by viruses such as cytomegaloviruses.

A substantial body of art has accumulated over the
35 past several decades with respect to substituted piperidines and pyrrolidines. These compounds have implicated in the treatment of a variety of disorders.

WO 98/25604 describes spiro-substituted azacycles which are useful as modulators of chemokine receptors:

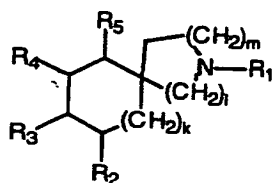

5

wherein R₁ is C₁₋₆ alkyl, optionally substituted with functional groups such as -NR⁶CONHR⁷, wherein R⁶ and R⁷ may be phenyl further substituted with hydroxy, alkyl, cyano, halo and haloalkyl. Such spiro compounds are not

10 considered part of the present invention.

WO 95/13069 is directed to certain piperidine, pyrrolidine, and hexahydro-1H-azepine compounds of general formula:

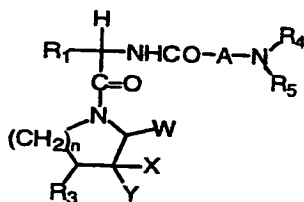

15

wherein A may be substituted alkyl or Z-substituted alkyl, with Z=NR_{6a} or O. Compounds of this type are claimed to promote the release of growth hormone in humans and animals.

20 WO 93/06108 discloses pyrrolobenzoxazine derivatives as 5-hydroxytryptamine (5-HT) agonists and antagonists:

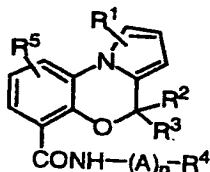

25 wherein A is lower alkylene and R⁴ may be phenyl optionally substituted with halogen.

U.S. Pat. No. 5,668,151 discloses Neuropeptide Y (NPY) antagonists comprising 1,4-dihydropyridines with a piperidinyl or tetrahydropyridinyl-containing moiety attached to the 3-position of the 4-phenyl ring:

5

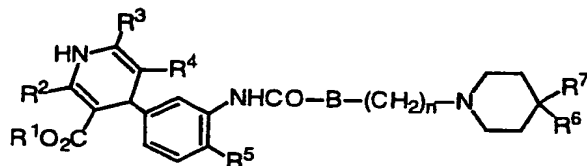

wherein B may be NH, NR¹, O, or a bond, and R⁷ may be substituted phenyl, benzyl, phenethyl and the like.

10 These reference compounds are readily distinguished structurally by either the nature of the urea functionality, the attachment chain, or the possible substitution of the present invention. The prior art does not disclose nor suggest the unique combination of
15 structural fragments which embody these novel piperidines and pyrrolidines as having activity toward the chemokine receptors.

SUMMARY OF THE INVENTION

20 Accordingly, one object of the present invention is to provide novel agonists or antagonists of CCR-3, or pharmaceutically acceptable salts or prodrugs thereof.

It is another object of the present invention to provide pharmaceutical compositions comprising a
25 pharmaceutically acceptable carrier and a therapeutically effective amount of at least one of the compounds of the present invention or a pharmaceutically acceptable salt or prodrug form thereof.

It is another object of the present invention to
30 provide a method for treating inflammatory diseases and allergic disorders comprising administering to a host in need of such treatment a therapeutically effective amount of at least one of the compounds of the present invention

or a pharmaceutically acceptable salt or prodrug form thereof.

It is another object of the present invention to provide novel N-ureidoalkyl-piperidines for use in therapy.

5 It is another object of the present invention to provide the use of novel N-ureidoalkyl-piperidines for the manufacture of a medicament for the treatment of allergic disorders.

10 In another embodiment, the present invention provides novel N-ureidoalkyl-piperidines for use in therapy.

In another embodiment, the present invention provides the use of novel N-ureidoalkyl-piperidines for the manufacture of a medicament for the treatment of allergic disorders.

15 These and other objects, which will become apparent during the following detailed description, have been achieved by the inventors' discovery that compounds of formula (I):

20

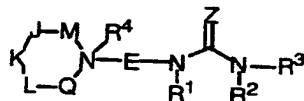

(I)

or stereoisomers or pharmaceutically acceptable salts thereof, wherein E, Z, M, J, K, L, Q, R¹, R², R³, and R⁴ are
25 defined below, are effective modulators of chemokine activity.

DETAILED DESCRIPTION OF PREFERRED EMBODIMENTS

30 [1] Thus, in a first embodiment, the present invention provides novel compounds of formula (I):

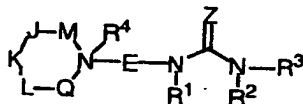

(I)

or stereoisomers or pharmaceutically acceptable salts thereof, wherein:

M is absent or selected from CH₂, CHR⁵, CHR¹³, CR¹³R¹³, and
5 CR⁵R¹³;

Q is selected from CH₂, CHR⁵, CHR¹³, CR¹³R¹³, and CR⁵R¹³;

J, K, and L are independently selected from CH₂, CHR⁵, CHR⁶,
10 CR⁶R⁶ and CR⁵R⁶;

with the provisos:

1) at least one of M, J, K, L, or Q contains an R⁵;
15 and

2) when M is absent, J is selected from CH₂, CHR⁵,
CHR¹³, and CR⁵R¹³;

20 Z is selected from O and S;

E is -(CHR⁷)-(CHR⁹)_v-(CHR¹¹)-;

R¹ and R² are independently selected from H, C₁₋₈ alkyl, C₂₋₈
25 alkenyl, C₂₋₈ alkynyl, (CH₂)_rC₃₋₆ cycloalkyl, and a
(CH₂)_r-C₃₋₁₀ carbocyclic residue substituted with 0-5
R^a;

R^a, at each occurrence, is selected from C₁₋₄ alkyl, C₂₋₈
30 alkenyl, C₂₋₈ alkynyl, (CH₂)_rC₃₋₆ cycloalkyl, Cl, Br, I,
F, (CF₂)_rCF₃, NO₂, CN, (CH₂)_rNR^bR^b, (CH₂)_rOH, (CH₂)_rOR^c,
(CH₂)_rSH, (CH₂)_rSR^c, (CH₂)_rC(O)R^b, (CH₂)_rC(O)NR^bR^b,
(CH₂)_rNR^bC(O)R^b, (CH₂)_rC(O)OR^b, (CH₂)_rOC(O)R^c,
(CH₂)_rCH(=NR^b)NR^bR^b, (CH₂)_rNHC(=NR^b)NR^bR^b, (CH₂)_rS(O)_pR^c,
35 (CH₂)_rS(O)₂NR^bR^b, (CH₂)_rNR^bS(O)₂R^c, and (CH₂)_rphenyl;

- R^b , at each occurrence, is selected from H, C₁₋₆ alkyl, C₃₋₆ cycloalkyl, and phenyl;
- R^c , at each occurrence, is selected from C₁₋₆ alkyl, C₃₋₆ cycloalkyl, and phenyl;
- 5 alternatively, R^2 and R^3 join to form a 5, 6, or 7-membered ring substituted with 0-3 R^a ;
- 10 R^3 is selected from a $(CR^{3'}R^{3''})_r$ -C₃₋₁₀ carbocyclic residue substituted with 0-5 R^{15} and a $(CR^{3'}R^{3''})_r$ -5-10 membered heterocyclic system containing 1-4 heteroatoms selected from N, O, and S, substituted with 0-3 R^{15} ;
- 15 $R^{3'}$ and $R^{3''}$, at each occurrence, are selected from H, C₁₋₆ alkyl, $(CH_2)_r$ C₃₋₆ cycloalkyl, and phenyl;
- R^4 is absent, taken with the nitrogen to which it is attached to form an N-oxide, or selected from C₁₋₈ alkyl, C₂₋₈ alkenyl, C₂₋₈ alkynyl, $(CH_2)_r$ C₃₋₆ cycloalkyl, $(CH_2)_qC(O)R^{4b}$, $(CH_2)_qC(O)NR^{4a}R^{4a'}$, $(CH_2)_qC(O)OR^{4b}$, and a $(CH_2)_r$ -C₃₋₁₀ carbocyclic residue substituted with 0-3 R^{4c} ;
- 20 R^{4a} and $R^{4a'}$, at each occurrence, are selected from H, C₁₋₆ alkyl, $(CH_2)_r$ C₃₋₆ cycloalkyl, and phenyl;
- R^{4b} , at each occurrence, is selected from C₁₋₆ alkyl, C₂₋₈ alkenyl, $(CH_2)_r$ C₃₋₆ cycloalkyl, C₂₋₈ alkynyl, and phenyl;
- 30 R^{4c} , at each occurrence, is selected from C₁₋₆ alkyl, C₂₋₈ alkenyl, C₂₋₈ alkynyl, C₃₋₆ cycloalkyl, Cl, F, Br, I, CN, NO₂, $(CF_2)_rCF_3$, $(CH_2)_rOC_{1-5}$ alkyl, $(CH_2)_rOH$, $(CH_2)_rSC_{1-5}$ alkyl, $(CH_2)_rNR^{4a}R^{4a'}$, and $(CH_2)_r$ phenyl;
- 35

- alternatively, R⁴ joins with R⁷, R⁹, or R¹¹ to form a 5, 6 or 7 membered piperidinium spirocycle or pyrrolidinium spirocycle substituted with 0-3 R^a;
- 5 R⁵ is selected from a (CR^{5'}R^{5''})_t-C₃₋₁₀ carbocyclic residue substituted with 0-5 R¹⁶ and a (CR^{5'}R^{5''})_t-5-10 membered heterocyclic system containing 1-4 heteroatoms selected from N, O, and S, substituted with 0-3 R¹⁶;
- 10 R^{5'} and R^{5''}, at each occurrence, are selected from H, C₁₋₆ alkyl, (CH₂)_rC₃₋₆ cycloalkyl, and phenyl;
- R⁶, at each occurrence, is selected from C₁₋₆ alkyl, C₂₋₈ alkenyl, C₂₋₈ alkynyl, (CH₂)_rC₃₋₆ cycloalkyl, (CF₂)_rCF₃,
 15 CN, (CH₂)_rNR^{6a}R^{6a'}, (CH₂)_rOH, (CH₂)_rOR^{6b}, (CH₂)_rSH,
 (CH₂)_rSR^{6b}, (CH₂)_rC(O)OH, (CH₂)_rC(O)R^{6b},
 (CH₂)_rC(O)NR^{6a}R^{6a'}, (CH₂)_rNR^{6d}C(O)R^{6a}, (CH₂)_rC(O)OR^{6b},
 (CH₂)_rOC(O)R^{6b}, (CH₂)_rS(O)_pR^{6b}, (CH₂)_rS(O)₂NR^{6a}R^{6a'},
 20 (CH₂)_rNR^{6d}S(O)₂R^{6b}, and (CH₂)_tphenyl substituted with 0-3 R^{6c};
- R^{6a} and R^{6a'}, at each occurrence, are selected from H, C₁₋₆ alkyl, C₃₋₆ cycloalkyl, and phenyl substituted with 0-3 R^{6c};
- 25 R^{6b}, at each occurrence, is selected from C₁₋₆ alkyl, C₃₋₆ cycloalkyl, and phenyl substituted with 0-3 R^{6c};
- R^{6c}, at each occurrence, is selected from C₁₋₆ alkyl, C₃₋₆ cycloalkyl, Cl, F, Br, I, CN, NO₂, (CF₂)_rCF₃, (CH₂)_rOC₁₋₅ alkyl, (CH₂)_rOH, (CH₂)_rSC₁₋₅ alkyl, and (CH₂)_rNR^{6d}R^{6d};
- 30 R^{6d}, at each occurrence, is selected from H, C₁₋₆ alkyl, and C₃₋₆ cycloalkyl;
- 35 with the proviso that when any of J, K, or L is CR⁶R⁶ and R⁶ is halogen, cyano, nitro, or bonded to the carbon to

which it is attached through a heteroatom, the other R⁶ is not halogen, cyano, or bonded to the carbon to which it is attached through a heteroatom;

5

R⁷ at each occurrence, is selected from H or alternatively R⁷ joins with R⁴ to form a 5, 6, or 7 membered piperidinium spirocycle or pyrrolidinium spirocycle substituted with 0-3R⁸;

10

R⁸ at each occurrence, is selected from H or alternatively R⁸ joins with R⁴ to form a 5, 6, or 7 membered piperidinium spirocycle or pyrrolidinium spirocycle substituted with 0-3R⁹;

15

R¹¹ at each occurrence, is selected from H, C₁₋₆alkyl, C₂₋₈alkenyl, C₂₋₈alkynyl, and a (CH₂)_r-C₃₋₁₀ carbocyclic residue substituted with 0-5 R^{11c}, or alternatively R¹¹ joins with R⁴ to form a 5, 6, or 7 membered piperidinium spirocycle or pyrrolidinium spirocycle substituted with 0-3R⁹;

20

R^{11a} and R^{11a'}, at each occurrence, are selected from H, C₁₋₆alkyl, C₂₋₈alkenyl, C₂₋₈alkynyl, a (CH₂)_r-C₃₋₁₀ carbocyclic residue substituted with 0-5 R^{11e}, and a (CH₂)_r-5-10 membered heterocyclic system containing 1-4 heteroatoms selected from N, O, and S, substituted with 0-3 R^{11e};

25

R^{11b}, at each occurrence, is selected from C₁₋₆alkyl, C₂₋₈alkenyl, C₂₋₈alkynyl, a (CH₂)_r-C₃₋₆ carbocyclic residue substituted with 0-2 R^{11e}, and a (CH₂)_r-5-6 membered heterocyclic system containing 1-4 heteroatoms selected from N, O, and S, substituted with 0-3 R^{11e};

30

35

R^{11c}, at each occurrence, is selected from C₁₋₆alkyl, C₂₋₈alkenyl, C₂₋₈alkynyl, (CH₂)_rC₃₋₆ cycloalkyl, Cl, Br, I,

- F, $(CF_2)_rCF_3$, NO_2 , CN , $(CH_2)_rNR^{11f}R^{11f}$, $(CH_2)_rOH$,
 $(CH_2)_rOC_{1-4}$ alkyl, $(CH_2)_rSC_{1-4}$ alkyl, $(CH_2)_rC(O)OH$,
 $(CH_2)_rC(O)R^{11b}$, $(CH_2)_rC(O)NR^{11f}R^{11f}$, $(CH_2)_rNR^{11f}C(O)R^{11a}$,
5 $(CH_2)_rC(O)OC_{1-4}$ alkyl, $(CH_2)_rOC(O)R^{11b}$,
 $(CH_2)_rC(=NR^{11f})NR^{11f}R^{11f}$, $(CH_2)_rNHC(=NR^{11f})NR^{11f}R^{11f}$,
 $(CH_2)_rS(O)_pR^{11b}$, $(CH_2)_rS(O)_2NR^{11f}R^{11f}$,
 $(CH_2)_rNR^{11f}S(O)_2R^{11b}$, and $(CH_2)_r$ phenyl substituted with
0-3 R^{11e} ;
- 10 R^{11e} , at each occurrence, is selected from C_{1-6} alkyl, C_{2-8}
alkenyl, C_{2-8} alkynyl, C_{3-6} cycloalkyl, Cl, F, Br, I,
 CN , NO_2 , $(CF_2)_rCF_3$, $(CH_2)_rOC_{1-5}$ alkyl, OH, SH, $(CH_2)_rSC_{1-5}$
alkyl, $(CH_2)_rNR^{11f}R^{11f}$, and $(CH_2)_r$ phenyl;
- 15 R^{11f} , at each occurrence, is selected from H, C_{1-6} alkyl,
and C_{3-6} cycloalkyl;
- R^{13} , at each occurrence, is selected from C_{1-6} alkyl, C_{2-8}
alkenyl, C_{2-8} alkynyl, C_{3-6} cycloalkyl, $(CF_2)_wCF_3$,
20 $(CH_2)NR^{13a}R^{13a'}$, $(CH_2)_qOH$, $(CH_2)_qOR^{13b}$, $(CH_2)_qSH$,
 $(CH_2)_qSR^{13b}$, $(CH_2)_wC(O)OH$, $(CH_2)_wC(O)R^{13b}$,
 $(CH_2)_wC(O)NR^{13a}R^{13a'}$, $(CH_2)_qNR^{13d}C(O)R^{13a}$,
 $(CH_2)_wC(O)OR^{13b}$, $(CH_2)_qOC(O)R^{13b}$, $(CH_2)_wS(O)_pR^{13b}$,
 $(CH_2)_wS(O)_2NR^{13a}R^{13a'}$, $(CH_2)_qNR^{13d}S(O)_2R^{13b}$, and $(CH_2)_w$ -
25 phenyl substituted with 0-3 R^{13c} ;
- R^{13a} and $R^{13a'}$, at each occurrence, are selected from H, C_{1-6}
alkyl, C_{3-6} cycloalkyl, and phenyl substituted with 0-3
 R^{13c} ;
- 30 R^{13b} , at each occurrence, is selected from C_{1-6} alkyl, C_{3-6}
cycloalkyl, and phenyl substituted with 0-3 R^{13c} ;
- R^{13c} , at each occurrence, is selected from C_{1-6} alkyl, C_{3-6}
35 cycloalkyl, Cl, F, Br, I, CN , NO_2 , $(CF_2)_rCF_3$, $(CH_2)_rOC_{1-5}$
alkyl, $(CH_2)_rOH$, $(CH_2)_rSC_{1-5}$ alkyl, and
 $(CH_2)_rNR^{13d}R^{13d}$;

R^{13d}, at each occurrence, is selected from H, C₁₋₆ alkyl, and C₃₋₆ cycloalkyl;

- 5 R¹⁵, at each occurrence, is selected from C₁₋₈ alkyl, (CH₂)_rC₃₋₆ cycloalkyl, Cl, Br, I, F, NO₂, CN, (CHR')_rNR^{15a}R^{15a'}, (CHR')_rOH, (CHR')_rO(CHR')_rR^{15d}, (CHR')_rSH, (CHR')_rC(O)H, (CHR')_rS(CHR')_rR^{15d}, (CHR')_rC(O)OH, (CHR')_rC(O)(CHR')_rR^{15b},
 10 (CHR')_rC(O)NR^{15a}R^{15a'}, (CHR')_rNR^{15f}C(O)(CHR')_rR^{15b}, (CHR')_rNR^{15f}C(O)NR^{15f}R^{15f}, (CHR')_rC(O)O(CHR')_rR^{15d}, (CHR')_rOC(O)(CHR')_rR^{15b}, (CHR')_rC(=NR^{15f})NR^{15a}R^{15a'}, (CHR')_rNHC(=NR^{15f})NR^{15f}R^{15f}, (CHR')_rS(O)_p(CHR')_rR^{15b}, (CHR')_rS(O)₂NR^{15a}R^{15a'}, (CHR')_rNR^{15f}S(O)₂(CHR')_rR^{15b}, C₁₋₆
 15 haloalkyl, C₂₋₈ alkenyl substituted with 0-3 R', C₂₋₈ alkynyl substituted with 0-3 R', (CHR')_rphenyl substituted with 0-3 R^{15e}, and a (CH₂)_{r-5-10} membered heterocyclic system containing 1-4 heteroatoms
 20 selected from N, O, and S, substituted with 0-2 R^{15e};
- R', at each occurrence, is selected from H, C₁₋₆ alkyl, C₂₋₈ alkenyl, C₂₋₈ alkynyl, (CH₂)_rC₃₋₆ cycloalkyl, and (CH₂)_rphenyl substituted with R^{15e};
- 25 R^{15a} and R^{15a'}, at each occurrence, are selected from H, C₁₋₆ alkyl, C₂₋₈ alkenyl, C₂₋₈ alkynyl, a (CH₂)_{r-C3-10} carbocyclic residue substituted with 0-5 R^{15e}, and a (CH₂)_{r-5-10} membered heterocyclic system containing 1-4
 30 heteroatoms selected from N, O, and S, substituted with 0-2 R^{15e};
- R^{15b}, at each occurrence, is selected from C₁₋₆ alkyl, C₂₋₈ alkenyl, C₂₋₈ alkynyl, a (CH₂)_{r-C3-6} carbocyclic residue substituted with 0-3 R^{15e}, and (CH₂)_{r-5-6} membered
 35 heterocyclic system containing 1-4 heteroatoms selected from N, O, and S, substituted with 0-2 R^{15e};

- 5 R^{15d} , at each occurrence, is selected from C_{2-8} alkenyl, C_{2-8} alkynyl, C_{1-6} alkyl substituted with 0-3 R^{15e} , a $(CH_2)_r$ - C_{3-10} carbocyclic residue substituted with 0-3 R^{15e} , and a $(CH_2)_r$ -5-6 membered heterocyclic system containing 1-4 heteroatoms selected from N, O, and S, substituted with 0-3 R^{15e} ;
- 10 R^{15e} , at each occurrence, is selected from C_{1-6} alkyl, C_{2-8} alkenyl, C_{2-8} alkynyl, $(CH_2)_r$ - C_{3-6} cycloalkyl, Cl, F, Br, I, CN, NO_2 , $(CF_2)_r$ - CF_3 , $(CH_2)_r$ - OC_{1-5} alkyl, OH, SH, $(CH_2)_r$ - SC_{1-5} alkyl, $(CH_2)_r$ - $NR^{15f}R^{15f}$, and $(CH_2)_r$ -phenyl;
- 15 R^{15f} , at each occurrence, is selected from H, C_{1-6} alkyl, C_{3-6} cycloalkyl, and phenyl;
- 20 R^{16} , at each occurrence, is selected from C_{1-8} alkyl, C_{2-8} alkenyl, C_{2-8} alkynyl, $(CH_2)_r$ - C_{3-6} cycloalkyl, Cl, Br, I, F, NO_2 , CN, $(CHR')_r$ - $NR^{16a}R^{16a'}$, $(CHR')_r$ -OH, $(CHR')_r$ -O $(CHR')_r$ - R^{16d} , $(CHR')_r$ -SH, $(CHR')_r$ -C(O)H, $(CHR')_r$ -S $(CHR')_r$ - R^{16d} , $(CHR')_r$ -C(O)OH, $(CHR')_r$ -C(O) $(CHR')_r$ - R^{16b} , $(CHR')_r$ -C(O) $NR^{16a}R^{16a'}$, $(CHR')_r$ - $NR^{16f}C(O)$ $(CHR')_r$ - R^{16b} , $(CHR')_r$ -C(O)O $(CHR')_r$ - R^{16d} , $(CHR')_r$ -OC(O) $(CHR')_r$ - R^{16b} , $(CHR')_r$ -C(=NR 16f) $NR^{16a}R^{16a'}$, $(CHR')_r$ -NHC(=NR 16f) $NR^{16f}R^{16f}$, $(CHR')_r$ -S(O) $_p$ $(CHR')_r$ - R^{16b} , $(CHR')_r$ -S(O) $_2$ $NR^{16a}R^{16a'}$, $(CHR')_r$ - $NR^{16f}S(O)_2$ $(CHR')_r$ - R^{16b} , C_{1-6} haloalkyl, C_{2-8} alkenyl substituted with 0-3 R' , C_{2-8} alkynyl substituted with 0-3 R' , and $(CHR')_r$ -phenyl substituted with 0-3 R^{16e} ;
- 30 R^{16a} and $R^{16a'}$, at each occurrence, are selected from H, C_{1-6} alkyl, C_{2-8} alkenyl, C_{2-8} alkynyl, a $(CH_2)_r$ - C_{3-10} carbocyclic residue substituted with 0-5 R^{16e} , and a $(CH_2)_r$ -5-10 membered heterocyclic system containing 1-4 heteroatoms selected from N, O, and S, substituted
- 35 with 0-2 R^{16e} ;

5 R^{16b}, at each occurrence, is selected from C₁₋₆ alkyl, C₂₋₈ alkenyl, C₂₋₈ alkynyl, a (CH₂)_rC₃₋₆ carbocyclic residue substituted with 0-3 R^{16e}, and a (CH₂)_{r-5-6} membered heterocyclic system containing 1-4 heteroatoms selected from N, O, and S, substituted with 0-2 R^{16e};

10 R^{16d}, at each occurrence, is selected from C₂₋₈ alkenyl, C₂₋₈ alkynyl, C₁₋₆ alkyl substituted with 0-3 R^{16e}, a (CH₂)_r-C₃₋₁₀ carbocyclic residue substituted with 0-3 R^{16e}, and a (CH₂)_{r-5-6} membered heterocyclic system containing 1-4 heteroatoms selected from N, O, and S, substituted with 0-3 R^{16e};

15 R^{16e}, at each occurrence, is selected from C₁₋₆ alkyl, C₂₋₈ alkenyl, C₂₋₈ alkynyl, (CH₂)_rC₃₋₆ cycloalkyl, Cl, F, Br, I, CN, NO₂, (CF₂)_rCF₃, (CH₂)_rOC₁₋₅ alkyl, OH, SH, (CH₂)_rSC₁₋₅ alkyl, (CH₂)_rNR^{16f}R^{16f}, and (CH₂)_rphenyl;

20 R^{16f}, at each occurrence, is selected from H, C₁₋₅ alkyl, and C₃₋₆ cycloalkyl, and phenyl;

v is selected from 1 and 2;

t is selected from 1 and 2;

25

w is selected from 0 and 1;

r is selected from 0, 1, 2, 3, 4, and 5;

30 q is selected from 1, 2, 3, 4, and 5; and

p is selected from 0, 1, 2, and 3.

35 [2] In a preferred embodiment, the present invention provides novel compounds of formula (I), wherein:

- R^4 is absent, taken with the nitrogen to which it is attached to form an N-oxide, or selected from C_{1-8} alkyl, $(CH_2)_rC_{3-6}$ cycloalkyl, and $(CH_2)_r$ -phenyl substituted with 0-3 R^{4c} ;
- 5 R^{4c} , at each occurrence, is selected from C_{1-6} alkyl, C_{2-8} alkenyl, C_{2-8} alkynyl, C_{3-6} cycloalkyl, Cl, F, Br, I, CN, NO_2 , $(CF_2)_rCF_3$, $(CH_2)_rOC_{1-5}$ alkyl, $(CH_2)_rOH$, $(CH_2)_rSC_{1-5}$ alkyl, $(CH_2)_rNR^{4a}R^{4a'}$, and $(CH_2)_r$ phenyl;
- 10 alternatively, R^4 joins with R^7 , R^9 , or R^{11} to form a 5, 6 or 7 membered piperidinium spirocycle or pyrrolidinium spirocycle substituted with 0-3 R^a ;
- 15 R^1 and R^2 are independently selected from H and C_{1-4} alkyl;
- R^6 , at each occurrence, is selected from C_{1-4} alkyl, C_{2-8} alkenyl, C_{2-8} alkynyl, $(CH_2)_rC_{3-6}$ cycloalkyl, $(CF_2)_rCF_3$, CN, $(CH_2)_rOH$, $(CH_2)_rOR^{6b}$, $(CH_2)_rC(O)R^{6b}$,
- 20 $(CH_2)_rC(O)NR^{6a}R^{6a'}$, $(CH_2)_rNR^{6d}C(O)R^{6a}$, and $(CH_2)_t$ phenyl substituted with 0-3 R^{6c} ;
- R^{6a} and $R^{6a'}$, at each occurrence, are selected from H, C_{1-6} alkyl, C_{3-6} cycloalkyl, and phenyl substituted with 0-3
- 25 R^{6c} ;
- R^{6b} , at each occurrence, is selected from C_{1-6} alkyl, C_{3-6} cycloalkyl, and phenyl substituted with 0-3 R^{6c} ;
- 30 R^{6c} , at each occurrence, is selected from C_{1-6} alkyl, C_{3-6} cycloalkyl, Cl, F, Br, I, CN, NO_2 , $(CF_2)_rCF_3$, $(CH_2)_rOC_{1-5}$ alkyl, $(CH_2)_rOH$, $(CH_2)_rSC_{1-5}$ alkyl, and $(CH_2)_rNR^{6d}R^{6d}$;
- R^{6d} , at each occurrence, is selected from H, C_{1-6} alkyl, and
- 35 C_{3-6} cycloalkyl;

5 R^{13} , at each occurrence, is selected from C_{1-4} alkyl, C_{3-6} cycloalkyl, $(CH_2)NR^{13a}R^{13a'}$, $(CH_2)OH$, $(CH_2)OR^{13b}$, $(CH_2)_wC(O)R^{13b}$, $(CH_2)_wC(O)NR^{13a}R^{13a'}$, $(CH_2)NR^{13d}C(O)R^{13a}$, $(CH_2)_wS(O)_2NR^{13a}R^{13a'}$, $(CH_2)NR^{13d}S(O)_2R^{13b}$, and $(CH_2)_w$ -phenyl substituted with 0-3 R^{13c} ;

10 R^{13a} and $R^{13a'}$, at each occurrence, are selected from H, C_{1-6} alkyl, C_{3-6} cycloalkyl, and phenyl substituted with 0-3 R^{13c} ;

15 R^{13b} , at each occurrence, is selected from C_{1-6} alkyl, C_{3-6} cycloalkyl, and phenyl substituted with 0-3 R^{13c} ;

20 R^{13c} , at each occurrence, is selected from C_{1-6} alkyl, C_{3-6} cycloalkyl, Cl, F, Br, I, CN, NO_2 , $(CF_2)_rCF_3$, $(CH_2)_rOC_{1-5}$ alkyl, $(CH_2)_rOH$, and $(CH_2)_rNR^{13d}R^{13d}$;

25 R^{13d} , at each occurrence, is selected from H, C_{1-6} alkyl, and C_{3-6} cycloalkyl;

v is selected from 1 and 2;

q is selected from 1, 2, and 3; and

30 r is selected from 0, 1, 2, and 3.

[3] In a more preferred embodiment, the present invention provides novel compounds of formula (I), wherein:

35 R^3 is selected from a $(CR^{3'}H)_r$ -carbocyclic residue substituted with 0-5 R^{15} , wherein the carbocyclic residue is selected from phenyl, C_{3-6} cycloalkyl, naphthyl, and adamantyl; and a $(CR^{3'}H)_r$ -heterocyclic system substituted with 0-3 R^{15} , wherein the heterocyclic system is selected from pyridinyl, thiophenyl, furanyl, indazolyl, benzothiazolyl, benzimidazolyl, benzothiophenyl, benzofuranyl,

benzoxazolyl, benzisoxazolyl, quinolinyl,
 isoquinolinyl, imidazolyl, indolyl, indolinyl,
 isoindolyl, isothiadiazolyl, isoxazolyl, piperidinyl,
 pyrrazolyl, 1,2,4-triazolyl, 1,2,3-triazolyl,
 5 tetrazolyl, thiadiazolyl, thiazolyl, oxazolyl,
 pyrazinyl, and pyrimidinyl; and

R⁵ is selected from (CR^{5'}H)_t-phenyl substituted with 0-5
 R¹⁶; and a (CR^{5'}H)_t-heterocyclic system substituted
 10 with 0-3 R¹⁶, wherein the heterocyclic system is
 selected from pyridinyl, thiophenyl, furanyl,
 indazolyl, benzothiazolyl, benzimidazolyl,
 benzothiophenyl, benzofuranyl, benzoxazolyl,
 benzisoxazolyl, quinolinyl, isoquinolinyl, imidazolyl,
 15 indolyl, indolinyl, isoindolyl, isothiadiazolyl,
 isoxazolyl, piperidinyl, pyrrazolyl, 1,2,4-triazolyl,
 1,2,3-triazolyl, tetrazolyl, thiadiazolyl, thiazolyl,
 oxazolyl, pyrazinyl, and pyrimidinyl.

20 [4] In an even more preferred embodiment, the present
 invention provides novel compounds of formula (I-i),
 wherein the compound of formula (I-i) is:

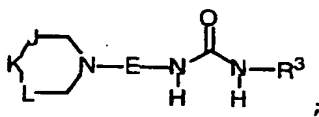

25

(I-i)

R¹⁶, at each occurrence, is selected from C₁₋₈ alkyl,
 (CH₂)_rC₃₋₆ cycloalkyl, CF₃, Cl, Br, I, F,
 (CH₂)_rNR^{16a}R^{16a'}, NO₂, CN, OH, (CH₂)_rOR^{16d},
 30 (CH₂)_rC(O)R^{16b}, (CH₂)_rC(O)NR^{16a}R^{16a'}, (CH₂)_rNR^{16f}C(O)R^{16b},
 (CH₂)_rS(O)_pR^{16b}, (CH₂)_rS(O)₂NR^{16a}R^{16a'},
 (CH₂)_rNR^{16f}S(O)₂R^{16b}, and (CH₂)_rphenyl substituted with
 0-3 R^{16e};

- R^{16a} and R^{16a'}, at each occurrence, are selected from H, C₁₋₆ alkyl, C₃₋₆ cycloalkyl, and (CH₂)_rphenyl substituted with 0-3 R^{16e};
- 5 R^{16b}, at each occurrence, is selected from H, C₁₋₆ alkyl, C₃₋₆ cycloalkyl, and (CH₂)_rphenyl substituted with 0-3 R^{16e};
- R^{16d}, at each occurrence, is selected from C₁₋₆ alkyl and
10 phenyl;
- R^{16e}, at each occurrence, is selected from C₁₋₆ alkyl, Cl, F, Br, I, CN, NO₂, (CF₂)_rCF₃, OH, and (CH₂)_rOC₁₋₅ alkyl; and
- 15 R^{16f}, at each occurrence, is selected from H, and C₁₋₅ alkyl.

- [5] In another even more preferred embodiment, the present
20 invention provides novel compounds of formula (I-ii), wherein the compound formula (I-ii) is:

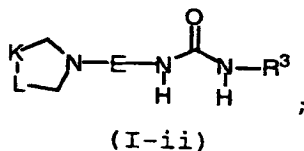

- 25 R¹⁶, at each occurrence, is selected from C₁₋₈ alkyl, (CH₂)_rC₃₋₆ cycloalkyl, CF₃, Cl, Br, I, F, (CH₂)_rNR^{16a}R^{16a'}, NO₂, CN, OH, (CH₂)_rOR^{16d}, (CH₂)_rC(O)R^{16b}, (CH₂)_rC(O)NR^{16a}R^{16a'}, (CH₂)_rNR^{16f}C(O)R^{16b},
30 (CH₂)_rS(O)_pR^{16b}, (CH₂)_rS(O)₂NR^{16a}R^{16a'}, (CH₂)_rNR^{16f}S(O)₂R^{16b}, and (CH₂)_rphenyl substituted with 0-3 R^{16e};
- R^{16a} and R^{16a'}, at each occurrence, are selected from H, C₁₋₆
35 alkyl, C₃₋₆ cycloalkyl, and (CH₂)_rphenyl substituted with 0-3 R^{16e};

R^{16b}, at each occurrence, is selected from H, C₁₋₆ alkyl, C₃₋₆ cycloalkyl, and (CH₂)_rphenyl substituted with 0-3 R^{16e};

5

R^{16d}, at each occurrence, is selected from C₁₋₆ alkyl and phenyl;

10 R^{16e}, at each occurrence, is selected from C₁₋₆ alkyl, Cl, F, Br, I, CN, NO₂, (CF₂)_rCF₃, OH, and (CH₂)_rOC₁₋₅ alkyl; and

R^{16f}, at each occurrence, is selected from H, and C₁₋₅ alkyl.

15

[6] In a preferred embodiment, the present invention provides novel compounds of formula (I-i) wherein:

R⁵ is CH₂phenyl substituted with 0-3 R¹⁶;

20

E is -CH₂-(CH₂)-(CH₂);

r is selected from 0, 1, and 2.

25 [7]. In another preferred embodiment, the present invention provides novel compounds of formula (I-ii), wherein:

E is -CH₂-(CHR⁹)-CHR¹¹;

30

R⁵ is CH₂phenyl substituted with 0-3 R¹⁶; and

r is selected from 0, 1, and 2.

35 [8] In a more preferred embodiment, the present invention provides novel compounds of formula (I-i), wherein:

- J is selected from CH_2 and CHR^5 ;
- K is selected from CH_2 and CHR^5 ;
- 5 L is selected from CH_2 and CHR^5 ;
- R^3 is a C_3 -10 carbocyclic residue substituted with 0-3 R^{15} ,
 wherein the carbocyclic residue is selected from
 cyclopropyl, cyclopentyl, cyclohexyl, phenyl, naphthyl
 10 and adamantyl, and a $(\text{CR}^{3'}\text{H})_r$ -heterocyclic system
 substituted with 0-3 R^{15} , wherein the heterocyclic
 system is selected from pyridinyl, thiophenyl,
 furanyl, indazolyl, benzothiazolyl, benzimidazolyl,
 15 benzothiophenyl, benzofuranyl, benzoxazolyl,
 benzisoxazolyl, quinolinyl, isoquinolinyl, imidazolyl,
 indolyl, indolinyl, isoindolyl, isothiadiaazolyl,
 isoxazolyl, piperidinyl, pyrrazolyl, 1,2,4-triazolyl,
 1,2,3-triazolyl, tetrazolyl, thiadiaazolyl, thiazolyl,
 20 oxazolyl, pyrazinyl, and pyrimidinyl; and
- R^{15} , at each occurrence, is selected from C_1 -8 alkyl,
 $(\text{CH}_2)_r\text{C}_3$ -6 cycloalkyl, CF_3 , Cl, Br, I, F,
 $(\text{CH}_2)_r\text{NR}^{15a}\text{R}^{15a'}$, NO_2 , CN, OH, $(\text{CH}_2)_r\text{OR}^{15d}$,
 $(\text{CH}_2)_r\text{C}(\text{O})\text{R}^{15b}$, $(\text{CH}_2)_r\text{C}(\text{O})\text{NR}^{15a}\text{R}^{15a'}$, $(\text{CH}_2)_r\text{NR}^{15f}\text{C}(\text{O})\text{R}^{15b}$,
 25 $(\text{CH}_2)_r\text{S}(\text{O})_p\text{R}^{15b}$, $(\text{CH}_2)_r\text{S}(\text{O})_2\text{NR}^{15a}\text{R}^{15a'}$,
 $(\text{CH}_2)_r\text{NR}^{15f}\text{S}(\text{O})_2\text{R}^{15b}$, $(\text{CH}_2)_r$ phenyl substituted with 0-3
 R^{15e} , and a $(\text{CH}_2)_r$ -5-6 membered heterocyclic system
 containing 1-4 heteroatoms selected from N, O, and S,
 30 substituted with 0-2 R^{15e} ;
- R^{15a} and $\text{R}^{15a'}$, at each occurrence, are selected from H, C_1 -6
 alkyl, C_3 -6 cycloalkyl, and $(\text{CH}_2)_r$ phenyl substituted
 with 0-3 R^{15e} ;
- 35 R^{15b} , at each occurrence, is selected from H, C_1 -6 alkyl,
 C_3 -6 cycloalkyl, and $(\text{CH}_2)_r$ phenyl substituted with 0-3
 R^{15e} ;

R^{15d}, at each occurrence, is selected from C₁₋₆ alkyl and phenyl;

5 R^{15e}, at each occurrence, is selected from C₁₋₆ alkyl, Cl, F, Br, I, CN, NO₂, (CF₂)_rCF₃, OH, and (CH₂)_rOC₁₋₅ alkyl; and

10 R^{15f}, at each occurrence, is selected from H, and C₁₋₅ alkyl.

[9] In another more preferred embodiment, the present invention provides novel compounds of formula (I-ii), wherein:

15 K is selected from CH₂ and CHR⁵;

L is selected from CH₂ and CHR⁵;

20 R³ is a C₃₋₁₀ carbocyclic residue substituted with 0-3 R¹⁵, wherein the carbocyclic residue is selected from cyclopropyl, cyclopentyl, cyclohexyl, phenyl, naphthyl and adamantyl, and a (CR^{3'}H)_r-heterocyclic system substituted with 0-3 R¹⁵, wherein the heterocyclic
25 system is selected from pyridinyl, thiophenyl, furanyl, indazolyl, benzothiazolyl, benzimidazolyl, benzothiophenyl, benzofuranyl, benzoxazolyl, benzisoxazolyl, quinolinyl, isoquinolinyl, imidazolyl, indolyl, indolinyl, isoindolyl, isothiadiazolyl,
30 isoxazolyl, piperidinyl, pyrrazolyl, 1,2,4-triazolyl, 1,2,3-triazolyl, tetrazolyl, thiadiazolyl, thiazolyl, oxazolyl, pyrazinyl, and pyrimidinyl; and

R¹⁵, at each occurrence, is selected from C₁₋₈ alkyl,
35 (CH₂)_rC₃₋₆ cycloalkyl, CF₃, Cl, Br, I, F,
(CH₂)_rNR^{15a}R^{15a'}, NO₂, CN, OH, (CH₂)_rOR^{15d},
(CH₂)_rC(O)R^{15b}, (CH₂)_rC(O)NR^{15a}R^{15a'}, (CH₂)_rNR^{15f}C(O)R^{15b},

(CH₂)_rS(O)_pR^{15b}, (CH₂)_rS(O)₂NR^{15a}R^{15a'},
(CH₂)_rNR^{15f}S(O)₂R^{15b}, (CH₂)_rphenyl substituted with 0-3
R^{15e}, and a (CH₂)_r-5-6 membered heterocyclic system
5 containing 1-4 heteroatoms selected from N, O, and S,
substituted with 0-2 R^{15e};

R^{15a} and R^{15a'}, at each occurrence, are selected from H, C₁₋₆
alkyl, C₃₋₆ cycloalkyl, and (CH₂)_rphenyl substituted
with 0-3 R^{15e};

10 R^{15b}, at each occurrence, is selected from H, C₁₋₆ alkyl,
C₃₋₆ cycloalkyl, and (CH₂)_rphenyl substituted with 0-3
R^{15e};

15 R^{15d}, at each occurrence, is selected from C₁₋₆ alkyl and
phenyl;

R^{15e}, at each occurrence, is selected from C₁₋₆ alkyl, Cl,
F, Br, I, CN, NO₂, (CF₂)_rCF₃, OH, and (CH₂)_rOC₁₋₅ alkyl;
20 and

R^{15f}, at each occurrence, is selected from H, and C₁₋₅ alkyl

[10] In a preferred embodiment, the present invention
25 provides novel compounds of formula (I), wherein:

M is absent or selected from CH₂;

30 Q is CH₂;

J is CH₂;

K and L are independently selected from CH₂ and CHR³;

35 Z is O;

R¹ is H;

R² is H;

R³ is a C₃₋₁₀ carbocyclic residue substituted with 0-3 R¹⁵,
5 wherein the carbocyclic residue is selected from
cyclopropyl, cyclopentyl, cyclohexyl, phenyl, naphthyl
and adamantyl, and a (CR^{3'}H)_r-heterocyclic system
substituted with 0-3 R¹⁵, wherein the heterocyclic
10 system is selected from pyridinyl, thiophenyl,
furanyl, indazolyl, benzothiazolyl, benzimidazolyl,
benzothiophenyl, benzofuranyl, benzoxazolyl,
benzisoxazolyl, quinolinyl, isoquinolinyl, imidazolyl,
indolyl, indolinyl, isoindolyl, isothiadiazolyl,
15 isoxazolyl, piperidinyl, pyrrazolyl, 1,2,4-triazolyl,
1,2,3-triazolyl, tetrazolyl, thiadiazolyl, thiazolyl,
oxazolyl, pyrazinyl, and pyrimidinyl; and

R⁵ is selected from a CH₂-C₃₋₁₀ carbocyclic residue
substituted with 1-5 R¹⁶ and a heterocyclic system
20 substituted with 0-3 R¹⁵, wherein the heterocyclic
system is selected from pyridinyl, thiophenyl,
furanyl, indazolyl, benzothiazolyl, benzimidazolyl,
benzothiophenyl, benzofuranyl, benzoxazolyl,
benzisoxazolyl, quinolinyl, isoquinolinyl, imidazolyl,
25 indolyl, indolinyl, isoindolyl, isothiadiazolyl,
isoxazolyl, piperidinyl, pyrrazolyl, 1,2,4-triazolyl,
1,2,3-triazolyl, tetrazolyl, thiadiazolyl, thiazolyl,
oxazolyl, pyrazinyl, and pyrimidinyl

30 [1-11] In a further even more preferred embodiment, the
present invention provides novel compounds of formula (I)
and pharmaceutically acceptable salt forms thereof, wherein
the compound of formula I is selected from:

35 N-(2-hydroxymethylphenyl)-N'-[3-[4-(phenylmethyl)-1-
piperidinyl]propyl]urea,

N-(3-carboethoxyphenyl)-N'-[3-[4-(phenylmethyl)-1-piperidinyl]propyl]urea,

5 N-(3-cyanophenyl)-N'-[3-[4-(phenylmethyl)-1-piperidinyl]propyl]urea,

N-[4-(benzyloxy)phenyl]-N'-[3-[4-(phenylmethyl)-1-piperidinyl]propyl]urea,

10 N-(3-iodophenyl)-N'-[3-[4-(phenylmethyl)-1-piperidinyl]propyl]urea,

N-(3-methoxyphenyl)-N'-[3-[4-(phenylmethyl)-1-piperidinyl]propyl]urea,

15 N-phenyl-N'-[3-[4-(phenylmethyl)-1-piperidinyl]propyl]urea,

N-(4-carboethoxyphenyl)-N'-[3-[4-(phenylmethyl)-1-piperidinyl]propyl]urea,

20 N-(4-fluorophenyl)-N'-[3-[4-(phenylmethyl)-1-piperidinyl]propyl]urea,

25 N-(2-methoxyphenyl)-N'-[3-[4-(phenylmethyl)-1-piperidinyl]propyl]urea,

N-(4-methoxyphenyl)-N'-[3-[4-(phenylmethyl)-1-piperidinyl]propyl]urea,

30 N-(3-cyanophenyl)-N'-[3-[4-(4-fluorophenylmethyl)-1-piperidinyl]propyl]urea,

N-(4-fluorophenyl)-N'-[3-[4-(4-fluorophenylmethyl)-1-piperidinyl]propyl]urea,

35 N-(4-carboethoxyphenyl)-N'-[3-[4-(4-fluorophenylmethyl)-1-piperidinyl]propyl]urea,

- N-(3-cyanophenyl)-N'-[3-[4-((3,4-methylenedioxy)phenylmethyl)-1-piperidinyl]propyl]urea,
- 5 N-(3-methoxyphenyl)-N'-[3-[4-(4-fluorophenylmethyl)-1-piperidinyl]propyl]urea,
- N-(3-carboethoxyphenyl)-N'-[3-[4-((3,4-methylenedioxy)phenylmethyl)-1-piperidinyl]propyl]urea,
- 10 N-(3-methoxyphenyl)-N'-[3-[4-((3,4-methylenedioxy)phenylmethyl)-1-piperidinyl]propyl]urea,
- N-(3-methoxyphenyl)-N'-[3-[4-((3-methoxy)phenylmethyl)-1-piperidinyl]propyl]urea,
- 15 N-(3-cyanophenyl)-N'-[3-[4-(4-fluorophenylmethyl)-1-methyl-1-piperidinium]propyl]urea iodide,
- 20 N-(4-cyanophenyl)-N'-[3-[4-(phenylmethyl)-1-piperidinyl]propyl]urea,
- N-(4-fluorophenyl)-N'-[3-[4-((3,4-methylenedioxy)phenylmethyl)-1-piperidinyl]propyl]urea,
- 25 N-(4-fluorophenyl)-N'-[3-[4-(2,4-bisfluorophenylmethyl)-1-piperidinyl]propyl]urea,
- N-(3-methoxyphenyl)-N'-[3-[4-(2,4-bisfluorophenylmethyl)-1-piperidinyl]propyl]urea,
- 30 N-(3-cyanophenyl)-N'-[3-[4-(2,4-bisfluorophenylmethyl)-1-piperidinyl]propyl]urea,
- 35 N-(phenylmethyl)-N'-[3-[4-(4-fluorophenylmethyl)-1-piperidinyl]propyl]urea,

- N-[1-(2-phenylethyl)]-N'-[3-[4-(4-fluorophenylmethyl)-1-piperidinyl]propyl]urea,
- 5 N-(2-fluorophenyl)-N'-[3-[4-(4-fluorophenylmethyl)-1-piperidinyl]propyl]urea,
- N-(3-fluorophenyl)-N'-[3-[4-(4-fluorophenylmethyl)-1-piperidinyl]propyl]urea,
- 10 N-(cyclohexyl)-N'-[3-[4-(4-fluorophenylmethyl)-1-piperidinyl]propyl]urea,
- N-[1-[trans-2-phenylcyclopropyl]]-N'-[3-[4-(4-fluorophenylmethyl)-1-piperidinyl]propyl]urea,
- 15 N-(3-methoxyphenyl)-N'-[3-[4-(4-methylphenylmethyl)-1-piperidinyl]propyl]urea,
- N-(3-cyanophenyl)-N'-[3-[4-(4-methylphenylmethyl)-1-piperidinyl]propyl]urea,
- 20 N-(3-cyanophenyl)-N'-[3-[4-(4-chlorophenylmethyl)-1-piperidinyl]propyl]urea,
- 25 N-(3-methoxyphenyl)-N'-[3-[4-(3-methoxyphenylmethyl)-1-piperidinyl]propyl]urea,
- N-(3-cyanophenyl)-N'-[3-[4-(3-methoxyphenylmethyl)-1-piperidinyl]propyl]urea,
- 30 N-(4-fluorophenyl)-N'-[3-[4-(3-methoxyphenylmethyl)-1-piperidinyl]propyl]urea,
- 35 N-(4-carboethoxyphenyl)-N'-[3-[4-(3-methoxyphenylmethyl)-1-piperidinyl]propyl]urea,

- N-(3-cyanophenyl)-N'-[3-[4-(2-fluorophenylmethyl)-1-piperidinyl]propyl]urea,
- 5 N-(3-fluorophenyl)-N'-[3-[4-(3-methoxyphenylmethyl)-1-piperidinyl]propyl]urea,
- N-(3-carboethoxyphenyl)-N'-[3-[4-(3-methoxyphenylmethyl)-1-piperidinyl]propyl]urea,
- 10 N-[3-acetylphenyl]-N'-[3-[4-(4-fluorophenylmethyl)-1-piperidinyl]propyl]urea,
- N-[3-(alpha-hydroxyethyl)phenyl]-N'-[3-[4-(4-fluorophenylmethyl)-1-piperidinyl]propyl]urea,
- 15 N-[4-acetylphenyl]-N'-[3-[4-(4-fluorophenylmethyl)-1-piperidinyl]propyl]urea,
- N-(3-methoxyphenyl)-N'-[3-[4-(phenylmethyl)-1-piperidinyl]propyl]urea,
- 20 cis-N-(3-methoxyphenyl)-N'-[3-[2,4-bis(phenylmethyl)-1-piperidinyl]propyl]urea,
- 25 N-(3-acetylphenyl)-N'-[3-[4-(4-fluorophenylmethyl)-1-piperidinyl]propyl]urea,
- N-(3-methoxyphenyl)-N'-[3-[4-(4-fluorophenylmethylidanyl)-1-piperidinyl]propyl]urea,
- 30 N-(4-acetylphenyl)-N'-[3-[4-(4-fluorophenylmethyl)-1-piperidinyl]propyl]urea,
- 35 N-(3-(1-hydroxyethyl)phenyl)-N'-[3-[4-(4-fluorophenylmethyl)-1-piperidinyl]propyl]urea hydrochloride,

- N-(3-acetylphenyl)-N'-[3-[4-(4-fluorophenylmethyl)-3-(phenylmethyl)-1-piperidinyl]propyl]urea,
- 5 N-(4-fluorophenyl)-N'-[3-[4-(4-fluorophenylmethyl)-3-(phenylmethyl)-1-piperidinyl]propyl]urea,
- N-(3-methoxyphenyl)-N'-[3-[4-(4-fluorophenylmethyl)-3-(phenylmethyl)-1-piperidinyl]propyl]urea,
- 10 N-(2-isopropylphenyl)-N'-[3-[4-(4-fluorophenylmethyl)-1-piperidinyl]propyl]urea,
- N-(2-trifluoromethylphenyl)-N'-[3-[4-(4-fluorophenylmethyl)-1-piperidinyl]propyl]urea,
- 15 N-(3-chlorophenyl)-N'-[3-[4-(4-fluorophenylmethyl)-1-piperidinyl]propyl]urea,
- N-(3-trifluoromethylphenyl)-N'-[3-[4-(4-fluorophenylmethyl)-1-piperidinyl]propyl]urea,
- 20 N-(2-chlorophenyl)-N'-[3-[4-(4-fluorophenylmethyl)-1-piperidinyl]propyl]urea,
- 25 N-(2,4-difluorophenyl)-N'-[3-[4-(4-fluorophenylmethyl)-1-piperidinyl]propyl]urea,
- N-(3-cyanophenyl)-N'-[3-[4-(4-fluorophenylmethyl)-1-piperidinyl]propyl]urea, hydrochloride,
- 30 N-(3-cyanophenyl)-N'-[3-[4-(naphth-1-ylmethyl)-1-piperidinyl]propyl]urea,
- N-(4-fluorophenyl)-N'-[3-[4-(naphth-1-ylmethyl)-1-piperidinyl]propyl]urea,
- 35 N-(3-methoxyphenyl)-N'-[3-[4-(naphth-1-ylmethyl)-1-piperidinyl]propyl]urea,

- N-(3-cyanophenyl)-N'-[3-[4-(3-methylphenylmethyl)-1-piperidinyl]propyl]urea,
- 5 N-(3-methoxyphenyl)-N'-[3-[4-(3-methylphenylmethyl)-1-piperidinyl]propyl]urea,
- N-(4-cyanophenyl)-N'-[3-[4-(4-fluorophenylmethyl)-1-piperidinyl]propyl]urea,
- 10 N-(4-fluorophenyl)-N'-[3-[4-(4-chlorophenyl)methyl-1-piperidinyl]propyl]urea,
- N-(3-methoxyphenyl)-N'-[3-[4-(4-chlorophenyl)methyl-1-piperidinyl]propyl]urea,
- 15 N-(3-cyanophenyl)-N'-[3-[4-(3,4-bisfluorophenyl)methyl-1-piperidinyl]propyl]urea,
- 20 N-(3-methoxyphenyl)-N'-[3-[4-(3,4-bisfluorophenyl)methyl-1-piperidinyl]propyl]urea,
- N-(4-fluorophenyl)-N'-[3-[4-(3,4-bisfluorophenyl)methyl-1-piperidinyl]propyl]urea,
- 25 N-(3-methoxyphenyl)-N'-[3-[4-(3-fluorophenyl)methyl-1-piperidinyl]propyl]urea,
- N-(3-cyanophenyl)-N'-[3-[4-(3-chlorophenyl)methyl-1-piperidinyl]propyl]urea,
- 30 N-(3-methoxyphenyl)-N'-[3-[4-(3-carbomethoxyphenyl)methyl-1-piperidinyl]propyl]urea,
- 35 N-(3-cyanophenyl)-N'-[3-[4-(3-carbomethoxyphenyl)methyl-1-piperidinyl]propyl]urea,

- N-(3-acetylphenyl)-N'-[3-[4-(4-fluorophenyl)methyl-1-piperidinyl]propyl]urea,
- 5 N-(3,5-diacetylphenyl)-N'-[3-[3-(4-fluorophenyl)methyl-1-piperidinyl]propyl]urea,
- N-(3-acetylphenyl)-N'-[3-[3-(4-fluorophenyl)methyl-1-piperidinyl]propyl]urea,
- 10 N-(3,5-diacetylphenyl)-N'-[3-[4-(4-fluorophenyl)methyl-1-piperidinyl]propyl]urea,
- N-(3-cyanophenyl)-N'-[1-phenyl-3-[4-(4-fluorophenylmethyl)-1-piperidinyl]propyl]urea,
- 15 N-(3-methoxyphenyl)-N'-[1-phenyl-3-[4-(phenylmethyl)-1-piperidinyl]propyl]urea,
- N-(3-cyanophenyl)-N'-[1-phenyl-3-[4-(phenylmethyl)-1-piperidinyl]propyl]urea,
- 20 N-(1-adamantyl)-N'-[1-phenyl-3-[4-(phenylmethyl)-1-piperidinyl]propyl]urea,
- 25 N-(4-fluorophenyl)-N'-[1-phenyl-3-[4-(phenylmethyl)-1-piperidinyl]propyl]urea
- N-(3-carboethoxyphenyl)-N'-[3-[3-(phenylmethyl)-1-piperidinyl]propyl]urea,
- 30 N-(3-cyanophenyl)-N'-[3-[3-(phenylmethyl)-1-piperidinyl]propyl]urea,
- N-(4-fluorophenyl)-N'-[3-[3-(phenylmethyl)-1-piperidinyl]propyl]urea,
- 35 N-phenyl-N'-[3-[3-(phenylmethyl)-1-piperidinyl]propyl]urea,

- N-(1-adamantyl)-N'-[3-[3-(phenylmethyl)-1-piperidinyl]propyl]urea,
- 5 N-(3-methoxyphenyl)-N'-[3-[3-(phenylmethyl)-1-piperidinyl]propyl]urea,
- N-(4-carboethoxyphenyl)-N'-[3-[3-(phenylmethyl)-1-piperidinyl]propyl]urea,
- 10 N-phenyl-N'-[3-[3-(4-fluorophenyl)methyl-1-piperidinyl]propyl]urea,
- N-(3-cyanophenyl)-N'-[3-[3-(4-fluorophenyl)methyl-1-piperidinyl]propyl]urea,
- 15 N-(1-adamantyl)-N'-[3-[3-(4-fluorophenyl)methyl-1-piperidinyl]propyl]urea,
- N-(3-methoxyphenyl)-N'-[3-[3-(4-fluorophenyl)methyl-1-piperidinyl]propyl]urea,
- 20 N-(3-carboethoxyphenyl)-N'-[3-[3-(4-fluorophenyl)methyl-1-piperidinyl]propyl]urea,
- 25 N-(4-fluorophenyl)-N'-[3-[3-(4-fluorophenyl)methyl-1-piperidinyl]propyl]urea,
- N-(3-cyanophenyl)-N'-[3-[3-[2-(phenyl)ethyl]-1-piperidinyl]propyl]urea,
- 30 N-(3-carboethoxyphenyl)-N'-[3-[3-[2-(phenyl)ethyl]-1-piperidinyl]propyl]urea,
- N-(4-carboethoxyphenyl)-N'-[3-[3-[2-(phenyl)ethyl]-1-piperidinyl]propyl]urea,
- 35 N-(4-fluorophenyl)-N'-[3-[3-[2-(phenyl)ethyl]-1-piperidinyl]propyl]urea,

- N-phenyl-N'-[3-[3-[2-(phenyl)ethyl]-1-piperidinyl]propyl]urea,
- 5 N-(1-adamantyl)-N'-[3-[3-[2-(phenyl)ethyl]-1-piperidinyl]propyl]urea,
- N-(3-methoxyphenyl)-N'-[3-[3-[2-(phenyl)ethyl]-1-piperidinyl]propyl]urea,
- 10 N-phenyl-N'-[3-[3-(4-fluorophenyl)methyl]-1-pyrrolinyl]propyl]urea,
- N-(3-cyanophenyl)-N'-[3-[3-(4-fluorophenyl)methyl]-1-pyrrolinyl]propyl]urea,
- 15 N-(3-methoxyphenyl)-N'-[3-[3-(4-fluorophenyl)methyl]-1-pyrrolinyl]propyl]urea,
- 20 N-(4-fluorophenyl)-N'-[3-[3-(4-fluorophenyl)methyl]-1-pyrrolinyl]propyl]urea,
- N-(3-carboethoxyphenyl)-N'-[3-[3-(4-fluorophenyl)methyl]-1-pyrrolinyl]propyl]urea,
- 25 N-(4-carboethoxyphenyl)-N'-[3-[3-(4-fluorophenyl)methyl]-1-pyrrolinyl]propyl]urea,
- N-(1-adamantyl)-N'-[3-[3-(4-fluorophenyl)methyl]-1-pyrrolinyl]propyl]urea,
- 30 N-phenyl-N'-[3-[3-(2-fluorophenyl)methyl]-1-piperidinyl]propyl]urea,
- 35 N-(3-cyanophenyl)-N'-[3-[3-(2-fluorophenyl)methyl]-1-piperidinyl]propyl]urea,

- N-(3-methoxyphenyl)-N'-[3-[3-(2-fluorophenyl)methyl-1-piperidinyl]propyl]urea,
- 5 N-(4-fluorophenyl)-N'-[3-[3-(2-fluorophenyl)methyl-1-piperidinyl]propyl]urea,
- N-(3-methoxyphenyl)-N'-[3-[3-(3-fluorophenyl)methyl-1-piperidinyl]propyl]urea,
- 10 N-(3-cyanophenyl)-N'-[3-[3-(3-fluorophenyl)methyl-1-piperidinyl]propyl]urea,
- N-(4-fluorophenyl)-N'-[3-[3-(3-fluorophenyl)methyl-1-piperidinyl]propyl]urea
- 15 N-[3-(1-methyltetrazol-5-yl)phenyl]-N'-[3-[4-(4-fluorophenylmethyl)-1-piperidinyl]propyl]urea,
- N-[3-(1-methyltetrazol-5-yl)phenyl]-N'-[3-[3-(4-fluorophenylmethyl)-1-piperidinyl]propyl]urea,
- 20 N-[3,5-bis(1-methyltetrazol-5-yl)phenyl]-N'-[3-[4-(4-fluorophenylmethyl)-1-piperidinyl]propyl]urea,
- 25 N-[3,5-bis(1-methyltetrazol-5-yl)phenyl]-N'-[3-[3-(4-fluorophenylmethyl)-1-piperidinyl]propyl]urea,
- N-[4-(1-methyltetrazol-5-yl)phenyl]-N'-[3-[4-(4-fluorophenylmethyl)-1-piperidinyl]propyl]urea, and
- 30 N-[4-(1-methyltetrazol-5-yl)phenyl]-N'-[3-[3-(4-fluorophenylmethyl)-1-piperidinyl]propyl]urea.

35

[1-12] In a further even more preferred embodiment, the present invention provides novel compounds of formula (I)

and pharmaceutically acceptable salts form thereof, wherein the compound of formula I is selected from:

5 N-(1-adamantyl)-N'-[3-[4-(phenylmethyl)-1-piperidinyl]propyl]urea, and

N-[1-(trans-2-phenylcyclopropyl)]-N'-[3-[4-(phenylmethyl)-1-piperidinyl]propyl]urea.

10 [1-13] In a further even more preferred embodiment, the present invention provides novel compounds of formula (I) and pharmaceutically acceptable salts form thereof, wherein the compound of formula I is selected from:

15 N-(3-methoxyphenyl)-N'-[3-[1,4-bis(phenylmethyl)-1-piperidinium]propyl]urea bromide,

20 N-(3-cyanophenyl)-N'-[3-[1,4-bis(phenylmethyl)-1-piperidinium]propyl]urea bromide,

N-(3-methoxyphenyl)-N'-[3-[1-methyl-4-(phenylmethyl)-1-piperidinium]propyl]urea bromide,

25 N-(3-cyanophenyl)-N'-[3-[1-methyl-4-(phenylmethyl)-1-piperidinium]propyl]urea bromide,

N-(3-cyanophenyl)-N'-[3-[1-(carbomethoxymethyl)-4-(phenylmethyl)-1-piperidinium]propyl]urea bromide,

30 N-(4-fluorophenyl)-N'-[3-[1-methyl-4-(phenylmethyl)-1-piperidinium]propyl]urea bromide,

N-(4-fluorophenyl)-N'-[3-[1,4-bis(phenylmethyl)-1-piperidinium]propyl]urea bromide,

35 N-(4-fluorophenyl)-N'-[3-[1-(carbomethoxymethyl)-4-(phenylmethyl)-1-piperidinium]propyl]urea bromide,

N-(3-cyanophenyl)-N'-[3-[1-(cyanomethyl)-4-(phenylmethyl)-1-piperidinium]propyl]urea bromide,

5 N-(3-cyanophenyl)-N'-[3-[1-(phenylcarbonylmethyl)-4-(phenylmethyl)-1-piperidinium]propyl]urea bromide,

N-(2-methoxyphenyl)-N'-[3-[1-methyl-4-(phenylmethyl)-1-piperidinium]propyl]urea bromide,

10 N-(4-methoxyphenyl)-N'-[3-[1-methyl-4-(phenylmethyl)-1-piperidinium]propyl]urea bromide,

N-(3-methoxyphenyl)-N'-[3-[1-oxo-4-(phenylmethyl)-1-piperidinium]propyl]urea, and

15 N-(3-methoxyphenyl)-N'-[3-[1-methyl-4-(phenylmethyl)-1-piperidinium]propyl]urea iodide.

[1-14] In a further even more preferred embodiment, the present invention provides novel compounds of formula (I) and pharmaceutically acceptable salts form thereof, wherein
20 the compound of formula I is selected from:

N-(3-cyanophenyl)-N'-[4-[4-(phenylmethyl)-1-piperidinyl]butyl]urea,

25 N-(3-acetylphenyl)-N'-[4-[4-(4-fluorophenylmethyl)-1-piperidinyl]butyl]urea,

30 N-(3,5-diacetylphenyl)-N'-[4-[4-(4-fluorophenylmethyl)-1-piperidinyl]butyl]urea,

N-(3-cyanophenyl)-N'-[4-[4-(4-fluorophenylmethyl)-1-piperidinyl]butyl]urea,

35 N-(3-acetylphenyl)-N'-[4-[3-(4-fluorophenylmethyl)-1-piperidinyl]butyl]urea,

- N-(3,5-diacetylphenyl)-N'-[4-[3-(4-fluorophenylmethyl)-1-piperidinyl]butyl]urea,
- 5 N-(3-cyanophenyl)-N'-[4-[3-(4-fluorophenylmethyl)-1-piperidinyl]butyl]urea,
- N-(3-methoxyphenyl)-N'-[4-[3-(4-fluorophenylmethyl)-1-piperidinyl]butyl]urea,
- 10 N-(4-fluorophenyl)-N'-[4-[3-(4-fluorophenylmethyl)-1-piperidinyl]butyl]urea,
- N-phenyl-N'-[4-[3-(4-fluorophenylmethyl)-1-piperidinyl]butyl]urea, N-[3-(1-methyltetrazol-5-yl)phenyl]-
- 15 N'-[4-[4-(4-fluorophenylmethyl)-1-piperidinyl]butyl]urea,
- N-[3-(1-methyltetrazol-5-yl)phenyl]-N'-[4-[3-(4-fluorophenylmethyl)-1-piperidinyl]butyl]urea,
- 20 N-[3,5-bis(1-methyltetrazol-5-yl)phenyl]-N'-[4-[4-(4-fluorophenylmethyl)-1-piperidinyl]butyl]urea,
- N-[3,5-bis(1-methyltetrazol-5-yl)phenyl]-N'-[4-[3-(4-fluorophenylmethyl)-1-piperidinyl]butyl]urea,
- 25 N-(3-carbomethoxyphenyl)-N'-[4-[4-(phenylmethyl)-1-piperidinyl]butyl]urea,
- N-(3-iodophenyl)-N'-[4-[4-(phenylmethyl)-1-piperidinyl]butyl]urea,
- 30 N-[1-(4-benzyloxyphenyl)]-N'-[4-[4-(phenylmethyl)-1-piperidinyl]butyl]urea,
- 35 N-(1-adamantyl)-N'-[4-[4-(phenylmethyl)-1-piperidinyl]butyl]urea,

N-(3-methoxyphenyl)-N'-[4-[4-(phenylmethyl)-1-piperidinyl]butyl]urea,

N-phenyl-N'-[4-[4-(phenylmethyl)-1-piperidinyl]butyl]urea,

5

N-(3-methoxyphenyl)-N'-[4-[4-(phenylmethyl)-1-piperidinyl]butyl]urea,

N-(4-carbomethoxyphenyl)-N'-[4-[4-(phenylmethyl)-1-piperidinyl]butyl]urea,

10

N-(4-cyanophenyl)-N'-[4-[4-(phenylmethyl)-1-piperidinyl]butyl]urea,

N-(3-acetylphenyl)-N'-{(2Z)-4-[3-(4-fluorobenzyl)-1-piperidinyl]-2-butenyl}urea,

15

N-(3-acetylphenyl)-N'-{(2E)-4-[3-(4-fluorobenzyl)-1-piperidinyl]-2-butenyl}urea,

N-(3-cyanophenyl)-N'-{(2Z)-4-[3-(4-fluorobenzyl)-1-piperidinyl]-2-butenyl}urea,

20

N-(4-fluorophenyl)-N'-{(2Z)-4-[3-(4-fluorobenzyl)-1-piperidinyl]-2-butenyl}urea, and

25

N-(3-acetylphenyl)-N'-{4-[3-(4-fluorobenzyl)-1-piperidinyl]-2-butenyl}urea

[15] In another embodiment, the present invention provides a pharmaceutical composition, comprising a pharmaceutically acceptable carrier and a therapeutically effective amount of a compound of the present invention.

30

[16] In another embodiment, the present invention provides a method for modulation of chemokine receptor activity comprising administering to a patient in need thereof a

35

therapeutically effective amount of the compounds of the present invention.

5 [17] In another embodiment, the present invention provides a method for treating or preventing inflammatory diseases, comprising administering to a patient in need thereof a therapeutically effective amount of a compound of the present invention.

10 [18] In another embodiment, the present invention provides a method for treating or preventing asthma, comprising administering to a patient in need thereof a therapeutically effective amount of a compound of the present invention.

15

[19] Thus, in another embodiment, the present invention provides novel compounds of formula (I):

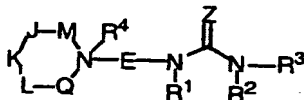

20

(I)

or stereoisomers or pharmaceutically acceptable salts thereof, wherein:

25 M is absent or selected from CH₂, CHR⁵, CHR¹³, CR¹³R¹³, and CR⁵R¹³;

Q is selected from CH₂, CHR⁵, CHR¹³, CR¹³R¹³, and CR⁵R¹³;

30 J, K, and L are independently selected from CH₂, CHR⁵, CHR⁶, CR⁶R⁶ and CR⁵R⁶;

with the provisos:

35 1) at least one of M, J, K, L, or Q contains an R⁵;
and

2) when M is absent, J is selected from CH_2 , CHR^5 , CHR^{13} , and CR^5R^{13} ;

Z is selected from NR^{1a} , CHCN , CHNO_2 , and $\text{C}(\text{CN})_2$;

5

R^{1a} is selected from H, C_{1-6} alkyl, C_{3-6} cycloalkyl, $\text{CONR}^{1b}\text{R}^{1b}$, OR^{1b} , CN , NO_2 , and $(\text{CH}_2)_w\text{phenyl}$;

R^{1b} is independently selected from H, C_{1-3} alkyl, C_{3-6} cycloalkyl, and phenyl;

10

E is $-(\text{CR}^7\text{R}^8)-(\text{CR}^9\text{R}^{10})_v-(\text{CR}^{11}\text{R}^{12})-$;

R^1 and R^2 are independently selected from H, C_{1-8} alkyl, C_{2-8} alkenyl, C_{2-8} alkynyl, $(\text{CH}_2)_r\text{C}_{3-6}$ cycloalkyl, and a $(\text{CH}_2)_r\text{-C}_{3-10}$ carbocyclic residue substituted with 0-5 R^a ;

15

R^a , at each occurrence, is selected from C_{1-4} alkyl, C_{2-8} alkenyl, C_{2-8} alkynyl, $(\text{CH}_2)_r\text{C}_{3-6}$ cycloalkyl, Cl, Br, I, F, $(\text{CF}_2)_r\text{CF}_3$, NO_2 , CN , $(\text{CH}_2)_r\text{NR}^b\text{R}^b$, $(\text{CH}_2)_r\text{OH}$, $(\text{CH}_2)_r\text{OR}^c$, $(\text{CH}_2)_r\text{SH}$, $(\text{CH}_2)_r\text{SR}^c$, $(\text{CH}_2)_r\text{C}(\text{O})\text{R}^b$, $(\text{CH}_2)_r\text{C}(\text{O})\text{NR}^b\text{R}^b$, $(\text{CH}_2)_r\text{NR}^b\text{C}(\text{O})\text{R}^b$, $(\text{CH}_2)_r\text{C}(\text{O})\text{OR}^b$, $(\text{CH}_2)_r\text{OC}(\text{O})\text{R}^c$, $(\text{CH}_2)_r\text{CH}(\text{=NR}^b)\text{NR}^b\text{R}^b$, $(\text{CH}_2)_r\text{NHC}(\text{=NR}^b)\text{NR}^b\text{R}^b$, $(\text{CH}_2)_r\text{S}(\text{O})_p\text{R}^c$, $(\text{CH}_2)_r\text{S}(\text{O})_2\text{NR}^b\text{R}^b$, $(\text{CH}_2)_r\text{NR}^b\text{S}(\text{O})_2\text{R}^c$, and $(\text{CH}_2)_r\text{phenyl}$;

20

25

R^b , at each occurrence, is selected from H, C_{1-6} alkyl, C_{3-6} cycloalkyl, and phenyl;

R^c , at each occurrence, is selected from C_{1-6} alkyl, C_{3-6} cycloalkyl, and phenyl;

30

alternatively, R^2 and R^3 join to form a 5, 6, or 7-membered ring substituted with 0-3 R^a ;

35

R^3 is selected from a $(\text{CR}^{3'}\text{R}^{3''})_r\text{-C}_{3-10}$ carbocyclic residue substituted with 0-5 R^{15} and a $(\text{CR}^{3'}\text{R}^{3''})_r\text{-5-10}$ membered

- heterocyclic system containing 1-4 heteroatoms selected from N, O, and S, substituted with 0-3 R¹⁵;
- 5 R^{3'} and R^{3''}, at each occurrence, are selected from H, C₁₋₆ alkyl, (CH₂)_rC₃₋₆ cycloalkyl, and phenyl;
- 10 R⁴ is absent, taken with the nitrogen to which it is attached to form an N-oxide, or selected from C₁₋₈ alkyl, C₂₋₈ alkenyl, C₂₋₈ alkynyl, (CH₂)_rC₃₋₆ cycloalkyl, (CH₂)_qC(O)R^{4b}, (CH₂)_qC(O)NR^{4a}R^{4a'}, (CH₂)_qC(O)OR^{4b}, and a (CH₂)_r-C₃₋₁₀ carbocyclic residue substituted with 0-3 R^{4c};
- 15 R^{4a} and R^{4a'}, at each occurrence, are selected from H, C₁₋₆ alkyl, (CH₂)_rC₃₋₆ cycloalkyl, and phenyl;
- 20 R^{4b}, at each occurrence, is selected from C₁₋₆ alkyl, C₂₋₈ alkenyl, (CH₂)_rC₃₋₆ cycloalkyl, C₂₋₈ alkynyl, and phenyl;
- 25 R^{4c}, at each occurrence, is selected from C₁₋₆ alkyl, C₂₋₈ alkenyl, C₂₋₈ alkynyl, C₃₋₆ cycloalkyl, Cl, F, Br, I, CN, NO₂, (CF₂)_rCF₃, (CH₂)_rOC₁₋₅ alkyl, (CH₂)_rOH, (CH₂)_rSC₁₋₅ alkyl, (CH₂)_rNR^{4a}R^{4a'}, and (CH₂)_rphenyl;
- alternatively, R⁴ joins with R⁷, R⁹, or R¹¹ to form a 5, 6 or 7-membered piperidinium spirocycle or pyrrolidinium spirocycle substituted with 0-3 R^a;
- 30 R⁵ is selected from a (CR^{5'}R^{5''})_t-C₃₋₁₀ carbocyclic residue substituted with 0-5 R¹⁶ and a (CR^{5'}R^{5''})_t-5-10 membered heterocyclic system containing 1-4 heteroatoms selected from N, O, and S, substituted with 0-3 R¹⁶;
- 35 R^{5'} and R^{5''}, at each occurrence, are selected from H, C₁₋₆ alkyl, (CH₂)_rC₃₋₆ cycloalkyl, and phenyl;

- R^6 , at each occurrence, is selected from C_{1-6} alkyl, C_{2-8} alkenyl, C_{2-8} alkynyl, $(CH_2)_r C_{3-6}$ cycloalkyl, $(CF_2)_r CF_3$, CN, $(CH_2)_r NR^{6a}R^{6a'}$, $(CH_2)_r OH$, $(CH_2)_r OR^{6b}$, $(CH_2)_r SH$, $(CH_2)_r SR^{6b}$, $(CH_2)_r C(O)OH$, $(CH_2)_r C(O)R^{6b}$,
 5 $(CH_2)_r C(O)NR^{6a}R^{6a'}$, $(CH_2)_r NR^{6d}C(O)R^{6a}$, $(CH_2)_r C(O)OR^{6b}$, $(CH_2)_r OC(O)R^{6b}$, $(CH_2)_r S(O)_p R^{6b}$, $(CH_2)_r S(O)_2 NR^{6a}R^{6a'}$, $(CH_2)_r NR^{6d}S(O)_2 R^{6b}$, and $(CH_2)_r$ phenyl substituted with 0-3 R^{6c} ;
- 10 R^{6a} and $R^{6a'}$, at each occurrence, are selected from H, C_{1-6} alkyl, C_{3-6} cycloalkyl, and phenyl substituted with 0-3 R^{6c} ;
- R^{6b} , at each occurrence, is selected from C_{1-6} alkyl, C_{3-6} cycloalkyl, and phenyl substituted with 0-3 R^{6c} ;
 15
- R^{6c} , at each occurrence, is selected from C_{1-6} alkyl, C_{3-6} cycloalkyl, Cl, F, Br, I, CN, NO_2 , $(CF_2)_r CF_3$, $(CH_2)_r OC_{1-5}$ alkyl, $(CH_2)_r OH$, $(CH_2)_r SC_{1-5}$ alkyl, and $(CH_2)_r NR^{6d}R^{6d}$;
 20
- R^{6d} , at each occurrence, is selected from H, C_{1-6} alkyl, and C_{3-6} cycloalkyl;
- R^7 , is selected from H, C_{1-6} alkyl, C_{2-8} alkenyl, C_{2-8} alkynyl, $(CH_2)_q OH$, $(CH_2)_q SH$, $(CH_2)_q OR^{7d}$, $(CH_2)_q SR^{7d}$, $(CH_2)_q NR^{7a}R^{7a'}$, $(CH_2)_r C(O)OH$, $(CH_2)_r C(O)R^{7b}$, $(CH_2)_r C(O)NR^{7a}R^{7a'}$, $(CH_2)_q NR^{7a}C(O)R^{7a}$, $(CH_2)_q NR^{7a}C(O)H$, $(CH_2)_r C(O)OR^{7b}$, $(CH_2)_q OC(O)R^{7b}$, $(CH_2)_q S(O)_p R^{7b}$, $(CH_2)_q S(O)_2 NR^{7a}R^{7a'}$, $(CH_2)_q NR^{7a}S(O)_2 R^{7b}$, C_{1-6} haloalkyl, a $(CH_2)_r$ - C_{3-10} carbocyclic residue substituted with 0-3 R^{7c} , and a $(CH_2)_r$ -5-10 membered heterocyclic system containing 1-4 heteroatoms selected from N, O, and S, substituted with 0-2 R^{7c} ;
 25
 30
- R^{7a} and $R^{7a'}$, at each occurrence, are selected from H, C_{1-6} alkyl, C_{2-8} alkenyl, C_{2-8} alkynyl, a $(CH_2)_r$ - C_{3-10} carbocyclic residue substituted with 0-5 R^{7e} , and a
 35

(CH₂)_r-5-10 membered heterocyclic system containing 1-4 heteroatoms selected from N, O, and S, substituted with 0-3 R^{7e};

- 5 R^{7b}, at each occurrence, is selected from C₁₋₆ alkyl, C₂₋₈ alkenyl, C₂₋₈ alkynyl, a (CH₂)_r-C₃₋₆ carbocyclic residue substituted with 0-2 R^{7e}, and a (CH₂)_r-5-6 membered heterocyclic system containing 1-4 heteroatoms selected from N, O, and S, substituted with 0-3 R^{7e};
- 10 R^{7c}, at each occurrence, is selected from C₁₋₆ alkyl, C₂₋₈ alkenyl, C₂₋₈ alkynyl, (CH₂)_r-C₃₋₆ cycloalkyl, Cl, Br, I, F, (CF₂)_rCF₃, NO₂, CN, (CH₂)_rNR^{7f}R^{7f}, (CH₂)_rOH, (CH₂)_rOC₁₋₄ alkyl, (CH₂)_rSC₁₋₄ alkyl, (CH₂)_rC(O)OH, (CH₂)_rC(O)R^{7b}, (CH₂)_rC(O)NR^{7f}R^{7f}, (CH₂)_rNR^{7f}C(O)R^{7a}, (CH₂)_rC(O)OC₁₋₄ alkyl, (CH₂)_rOC(O)R^{7b}, (CH₂)_rC(=NR^{7f})NR^{7f}R^{7f}, (CH₂)_rS(O)_pR^{7b}, (CH₂)_rNHC(=NR^{7f})NR^{7f}R^{7f}, (CH₂)_rS(O)₂NR^{7f}R^{7f}, (CH₂)_rNR^{7f}S(O)₂R^{7b}, and (CH₂)_rphenyl substituted with 0-3 R^{7e};
- 15 R^{7d}, at each occurrence, is selected from C₁₋₆ alkyl substituted with 0-3 R^{7e}, alkenyl, alkynyl, and a C₃₋₁₀ carbocyclic residue substituted with 0-3 R^{7c};
- 20 R^{7e}, at each occurrence, is selected from C₁₋₆ alkyl, C₂₋₈ alkenyl, C₂₋₈ alkynyl, C₃₋₆ cycloalkyl, Cl, F, Br, I, CN, NO₂, (CF₂)_rCF₃, (CH₂)_rOC₁₋₅ alkyl, OH, SH, (CH₂)_rSC₁₋₅ alkyl, (CH₂)_rNR^{7f}R^{7f}, and (CH₂)_rphenyl;
- 25 R^{7f}, at each occurrence, is selected from H, C₁₋₆ alkyl, and C₃₋₆ cycloalkyl;
- 30 R⁸ is selected from H, C₁₋₆ alkyl, C₃₋₆ cycloalkyl, and (CH₂)_rphenyl substituted with 0-3 R^{8a};
- 35

R^{8a}, at each occurrence, is selected from C₁₋₆ alkyl, C₂₋₈ alkenyl, C₂₋₈ alkynyl, C₃₋₆ cycloalkyl, Cl, F, Br, I, CN, NO₂, (CF₂)_rCF₃, (CH₂)_rOC₁₋₅ alkyl, OH, SH, (CH₂)_rSC₁₋₅ alkyl, (CH₂)_rNR^{7f}R^{7f}, and (CH₂)_rphenyl;

5

alternatively, R⁷ and R⁸ join to form C₃₋₇ cycloalkyl, or =NR^{8b};

R^{8b} is selected from H, C₁₋₆ alkyl, C₃₋₆ cycloalkyl, OH, CN, and (CH₂)_r-phenyl;

10

R⁹, is selected from H, C₁₋₆ alkyl, C₂₋₈ alkenyl, C₂₋₈ alkynyl, F, Cl, Br, I, NO₂, CN, (CH₂)_rOH, (CH₂)_rSH, (CH₂)_rOR^{9d}, (CH₂)_rSR^{9d}, (CH₂)_rNR^{9a}R^{9a'}, (CH₂)_rC(O)OH, (CH₂)_rC(O)R^{9b}, (CH₂)_rC(O)NR^{9a}R^{9a'}, (CH₂)_rNR^{9a}C(O)R^{9a}, (CH₂)_rNR^{9a}C(O)H, (CH₂)_rNR^{9a}C(O)NHR^{9a}, (CH₂)_rC(O)OR^{9b}, (CH₂)_rOC(O)R^{9b}, (CH₂)_rOC(O)NHR^{9a}, (CH₂)_rS(O)_pR^{9b}, (CH₂)_rS(O)₂NR^{9a}R^{9a'}, (CH₂)_rNR^{9a}S(O)₂R^{9b}, C₁₋₆ haloalkyl, a (CH₂)_r-C₃₋₁₀ carbocyclic residue substituted with 0-5 R^{9c}, and a (CH₂)_r-5-10 membered heterocyclic system containing 1-4 heteroatoms selected from N, O, and S, substituted with 0-3 R^{9c};

15

20

R^{9a} and R^{9a'}, at each occurrence, are selected from H, C₁₋₆ alkyl, C₂₋₈ alkenyl, C₂₋₈ alkynyl, a (CH₂)_r-C₃₋₁₀ carbocyclic residue substituted with 0-5 R^{9e}, and a (CH₂)_r-5-10 membered heterocyclic system containing 1-4 heteroatoms selected from N, O, and S, substituted with 0-3 R^{9e};

25

30

R^{9b}, at each occurrence, is selected from C₁₋₆ alkyl, C₂₋₈ alkenyl, C₂₋₈ alkynyl, a (CH₂)_r-C₃₋₆ carbocyclic residue substituted with 0-2 R^{9e}, and a (CH₂)_r-5-6 membered heterocyclic system containing 1-4 heteroatoms selected from N, O, and S, substituted with 0-3 R^{9e};

35

- R^{9c} , at each occurrence, is selected from C₁₋₆ alkyl, C₂₋₈ alkenyl, C₂₋₈ alkynyl, (CH₂)_rC₃₋₆ cycloalkyl, Cl, Br, I, F, (CF₂)_rCF₃, NO₂, CN, (CH₂)_rNR^{9f}R^{9f}, (CH₂)_rOH, (CH₂)_rOC₁₋₄ alkyl, (CH₂)_rSC₁₋₄ alkyl, (CH₂)_rC(O)OH, (CH₂)_rC(O)R^{9b}, (CH₂)_rC(O)NR^{9f}R^{9f}, (CH₂)_rNR^{9f}C(O)R^{9a}, (CH₂)_rC(O)OC₁₋₄ alkyl, (CH₂)_rOC(O)R^{9b}, (CH₂)_rC(=NR^{9f})NR^{9f}R^{9f}, (CH₂)_rS(O)_pR^{9b}, (CH₂)_rNHC(=NR^{9f})NR^{9f}R^{9f}, (CH₂)_rS(O)₂NR^{9f}R^{9f}, (CH₂)_rNR^{9f}S(O)₂R^{9b}, and (CH₂)_rphenyl substituted with 0-3 R^{9e};
- R^{9d} , at each occurrence, is selected from C₁₋₆ alkyl, C₂₋₆ alkenyl, C₂₋₆ alkynyl, a C₃₋₁₀ carbocyclic residue substituted with 0-3 R^{9c}, and a 5-6 membered heterocyclic system containing 1-4 heteroatoms selected from the group consisting of N, O, and S substituted with 0-3 R^{9c};
- R^{9e} , at each occurrence, is selected from C₁₋₆ alkyl, C₂₋₈ alkenyl, C₂₋₈ alkynyl, (CH₂)_rC₃₋₆ cycloalkyl, Cl, F, Br, I, CN, NO₂, (CF₂)_rCF₃, (CH₂)_rOC₁₋₅ alkyl, OH, SH, (CH₂)_rSC₁₋₅ alkyl, (CH₂)_rNR^{9f}R^{9f}, and (CH₂)_rphenyl;
- R^{9f} , at each occurrence, is selected from H, C₁₋₆ alkyl, and C₃₋₆ cycloalkyl;
- R^{10} , is selected from H, C₁₋₆ alkyl, C₂₋₈ alkenyl, C₂₋₈ alkynyl, F, Cl, Br, I, NO₂, CN, (CH₂)_rOH, (CH₂)_rOR^{10d}, (CH₂)_rSR^{10d}, (CH₂)_rNR^{10a}R^{10a'}, (CH₂)_rC(O)OH, (CH₂)_rC(O)R^{10b}, (CH₂)_rC(O)NR^{10a}R^{10a'}, (CH₂)_rNR^{10a}C(O)R^{10a}, (CH₂)_rNR^{10a}C(O)H, (CH₂)_rC(O)OR^{10b}, (CH₂)_rOC(O)R^{10b}, (CH₂)_rS(O)_pR^{10b}, (CH₂)_rS(O)₂NR^{10a}R^{10a'}, (CH₂)_rNR^{10a}S(O)₂R^{10b}, C₁₋₆ haloalkyl, a (CH₂)_r-C₃₋₁₀ carbocyclic residue substituted with 0-5 R^{10c}, and a (CH₂)_r-5-10 membered heterocyclic system containing 1-4 heteroatoms selected from N, O, and S, substituted with 0-3 R^{10c};

- 5 R^{10a} and $R^{10a'}$, at each occurrence, are selected from H, C_{1-6} alkyl, C_{2-8} alkenyl, C_{2-8} alkynyl, a $(CH_2)_r-C_{3-10}$ carbocyclic residue substituted with 0-5 R^{10e} , and a $(CH_2)_r-5-10$ membered heterocyclic system containing 1-4 heteroatoms selected from N, O, and S, substituted with 0-3 R^{10e} ;
- 10 R^{10b} , at each occurrence, is selected from C_{1-6} alkyl, C_{2-8} alkenyl, C_{2-8} alkynyl, a $(CH_2)_r-C_{3-6}$ carbocyclic residue substituted with 0-2 R^{10e} , and a $(CH_2)_r-5-6$ membered heterocyclic system containing 1-4 heteroatoms selected from N, O, and S, substituted with 0-3 R^{10e} ;
- 15 R^{10c} , at each occurrence, is selected from C_{1-6} alkyl, C_{2-8} alkenyl, C_{2-8} alkynyl, $(CH_2)_r-C_{3-6}$ cycloalkyl, Cl, Br, I, F, $(CF_2)_rCF_3$, NO_2 , CN, $(CH_2)_rNR^{10f}R^{10f}$, $(CH_2)_rOH$, $(CH_2)_rOC_{1-4}$ alkyl, $(CH_2)_rSC_{1-4}$ alkyl, $(CH_2)_rC(O)OH$, $(CH_2)_rC(O)R^{10b}$, $(CH_2)_rC(O)NR^{10f}R^{10f}$, $(CH_2)_rNR^{10f}C(O)R^{10a}$, $(CH_2)_rC(O)OC_{1-4}$ alkyl, $(CH_2)_rOC(O)R^{10b}$, $(CH_2)_rC(=NR^{10f})NR^{10f}R^{10f}$, $(CH_2)_rS(O)_pR^{10b}$, $(CH_2)_rNHC(=NR^{10f})NR^{10f}R^{10f}$, $(CH_2)_rS(O)_2NR^{10f}R^{10f}$, $(CH_2)_rNR^{10f}S(O)_2R^{10b}$, and $(CH_2)_r$ phenyl substituted with 0-3 R^{10e} ;
- 25 R^{10d} , at each occurrence, is selected from C_{1-6} alkyl, C_{2-6} alkenyl, C_{2-6} alkynyl, a C_{3-10} carbocyclic residue substituted with 0-3 R^{10c} , and a 5-6 membered heterocyclic system containing 1-4 heteroatoms selected from the group consisting of N, O, and S substituted with 0-3 R^{10c} ;
- 30 R^{10e} , at each occurrence, is selected from C_{1-6} alkyl, C_{2-8} alkenyl, C_{2-8} alkynyl, $(CH_2)_r-C_{3-6}$ cycloalkyl, Cl, F, Br, I, CN, NO_2 , $(CF_2)_rCF_3$, $(CH_2)_rOC_{1-5}$ alkyl, OH, SH, $(CH_2)_rSC_{1-5}$ alkyl, $(CH_2)_rNR^{10f}R^{10f}$, and $(CH_2)_r$ phenyl;
- 35

R^{10f}, at each occurrence, is selected from H, C₁₋₆ alkyl, and C₃₋₆ cycloalkyl;

alternatively, R⁹ and R¹⁰ join to form C₃₋₇ cycloalkyl, 5-6-
5 membered cyclic ketal, or =O;

with the proviso that when R¹⁰ is -OH, R⁹ is not halogen, cyano, or bonded to the carbon to which it is attached through a heteroatom;

10

R¹¹, is selected from H, C₁₋₆ alkyl, C₂₋₈ alkenyl, C₂₋₈ alkynyl, (CH₂)_qOH, (CH₂)_qSH, (CH₂)_qOR^{11d}, (CH₂)_qSR^{11d}, (CH₂)_qNR^{11a}R^{11a'}, (CH₂)_rC(O)OH, (CH₂)_rC(O)R^{11b}, (CH₂)_rC(O)NR^{11a}R^{11a'}, (CH₂)_qNR^{11a}C(O)R^{11a},
15 (CH₂)_qNR^{11a}C(O)NHR^{11a}, (CH₂)_rC(O)OR^{11b}, (CH₂)_qOC(O)R^{11b}, (CH₂)_qS(O)_pR^{11b}, (CH₂)_qS(O)₂NR^{11a}R^{11a'}, (CH₂)_qNR^{11a}S(O)₂R^{11b}, C₁₋₆ haloalkyl, a (CH₂)_r-C₃₋₁₀ carbocyclic residue substituted with 0-5 R^{11c}, and a (CH₂)_r-5-10 membered heterocyclic system containing 1-4
20 heteroatoms selected from N, O, and S, substituted with 0-3 R^{11c};

R^{11a} and R^{11a'}, at each occurrence, are selected from H, C₁₋₆ alkyl, C₂₋₈ alkenyl, C₂₋₈ alkynyl, a (CH₂)_r-C₃₋₁₀ carbocyclic residue substituted with 0-5 R^{11c}, and a (CH₂)_r-5-10 membered heterocyclic system containing 1-4 heteroatoms selected from N, O, and S, substituted with 0-3 R^{11c};

25

R^{11b}, at each occurrence, is selected from C₁₋₆ alkyl, C₂₋₈ alkenyl, C₂₋₈ alkynyl, a (CH₂)_r-C₃₋₆ carbocyclic residue substituted with 0-2 R^{11c}, and a (CH₂)_r-5-6 membered heterocyclic system containing 1-4 heteroatoms selected from N, O, and S, substituted with 0-3 R^{11c};

30

35

R^{11c}, at each occurrence, is selected from C₁₋₆ alkyl, C₂₋₈ alkenyl, C₂₋₈ alkynyl, (CH₂)_rC₃₋₆ cycloalkyl, Cl, Br, I,

- F, $(CF_2)_rCF_3$, NO_2 , CN , $(CH_2)_rNR^{11f}R^{11f}$, $(CH_2)_rOH$,
 $(CH_2)_rOC_{1-4}$ alkyl, $(CH_2)_rSC_{1-4}$ alkyl, $(CH_2)_rC(O)OH$,
 $(CH_2)_rC(O)R^{11b}$, $(CH_2)_rC(O)NR^{11f}R^{11f}$, $(CH_2)_rNR^{11f}C(O)R^{11a}$,
 $(CH_2)_rC(O)OC_{1-4}$ alkyl, $(CH_2)_rOC(O)R^{11b}$,
5 $(CH_2)_rC(=NR^{11f})NR^{11f}R^{11f}$, $(CH_2)_rNHC(=NR^{11f})NR^{11f}R^{11f}$,
 $(CH_2)_rS(O)_pR^{11b}$, $(CH_2)_rS(O)_2NR^{11f}R^{11f}$,
 $(CH_2)_rNR^{11f}S(O)_2R^{11b}$, and $(CH_2)_r$ phenyl substituted with
0-3 R^{11e} ;
- 10 R^{11d} , at each occurrence, is selected from C_{1-6} alkyl
substituted with 0-3 R^{11e} , C_{2-6} alkenyl, C_{2-6} alkynyl,
and a C_{3-10} carbocyclic residue substituted with 0-3
 R^{11c} ;
- 15 R^{11e} , at each occurrence, is selected from C_{1-6} alkyl, C_{2-8}
alkenyl, C_{2-8} alkynyl, C_{3-6} cycloalkyl, Cl, F, Br, I,
CN, NO_2 , $(CF_2)_rCF_3$, $(CH_2)_rOC_{1-5}$ alkyl, OH, SH, $(CH_2)_rSC_{1-5}$
alkyl, $(CH_2)_rNR^{11f}R^{11f}$, and $(CH_2)_r$ phenyl;
- 20 R^{11f} , at each occurrence, is selected from H, C_{1-6} alkyl,
and C_{3-6} cycloalkyl;
- R^{12} is selected from H, C_{1-6} alkyl, $(CH_2)_qOH$, $(CH_2)_rC_{3-6}$
cycloalkyl, and $(CH_2)_t$ phenyl substituted with 0-3 R^{12a} ;
- 25 R^{12a} , at each occurrence, is selected from C_{1-6} alkyl, C_{2-8}
alkenyl, C_{2-8} alkynyl, C_{3-6} cycloalkyl, Cl, F, Br, I,
CN, NO_2 , $(CF_2)_rCF_3$, $(CH_2)_rOC_{1-5}$ alkyl, OH, SH, $(CH_2)_rSC_{1-5}$
alkyl, $(CH_2)_rNR^{9f}R^{9f}$, and $(CH_2)_r$ phenyl;
- 30 alternatively, R^{11} and R^{12} join to form C_{3-7} cycloalkyl;
- R^{13} , at each occurrence, is selected from C_{1-6} alkyl, C_{2-8}
alkenyl, C_{2-8} alkynyl, C_{3-6} cycloalkyl, $(CF_2)_wCF_3$,
35 $(CH_2)NR^{13a}R^{13a'}$, $(CH_2)OH$, $(CH_2)OR^{13b}$, $(CH_2)SH$,
 $(CH_2)SR^{13b}$, $(CH_2)_wC(O)OH$, $(CH_2)_wC(O)R^{13b}$,
 $(CH_2)_wC(O)NR^{13a}R^{13a'}$, $(CH_2)NR^{13d}C(O)R^{13a}$, $(CH_2)_wC(O)OR^{13b}$,

$(\text{CH}_2)\text{OC}(\text{O})\text{R}^{13\text{b}}$, $(\text{CH}_2)_w\text{S}(\text{O})_p\text{R}^{13\text{b}}$, $(\text{CH}_2)_w\text{S}(\text{O})_2\text{NR}^{13\text{a}}\text{R}^{13\text{a}'}$,
 $(\text{CH}_2)\text{NR}^{13\text{d}}\text{S}(\text{O})_2\text{R}^{13\text{b}}$, and $(\text{CH}_2)_w$ -phenyl substituted with
 0-3 $\text{R}^{13\text{c}}$;

- 5 $\text{R}^{13\text{a}}$ and $\text{R}^{13\text{a}'}$, at each occurrence, are selected from H, C_{1-6}
 alkyl, C_{3-6} cycloalkyl, and phenyl substituted with 0-3
 $\text{R}^{13\text{c}}$;
- 10 $\text{R}^{13\text{b}}$, at each occurrence, is selected from C_{1-6} alkyl, C_{3-6}
 cycloalkyl, and phenyl substituted with 0-3 $\text{R}^{13\text{c}}$;
- 15 $\text{R}^{13\text{c}}$, at each occurrence, is selected from C_{1-6} alkyl, C_{3-6}
 cycloalkyl, Cl, F, Br, I, CN, NO_2 , $(\text{CF}_2)_r\text{CF}_3$, $(\text{CH}_2)_r\text{OC}_{1-5}$
 alkyl, $(\text{CH}_2)_r\text{OH}$, $(\text{CH}_2)_r\text{SC}_{1-5}$ alkyl, and
 $(\text{CH}_2)_r\text{NR}^{13\text{d}}\text{R}^{13\text{d}}$;
- $\text{R}^{13\text{d}}$, at each occurrence, is selected from H, C_{1-6} alkyl,
 and C_{3-6} cycloalkyl;
- 20 R^{15} , at each occurrence, is selected from C_{1-8} alkyl,
 $(\text{CH}_2)_r\text{C}_{3-6}$ cycloalkyl, Cl, Br, I, F, NO_2 , CN,
 $(\text{CHR}')_r\text{NR}^{15\text{a}}\text{R}^{15\text{a}'}$, $(\text{CHR}')_r\text{OH}$, $(\text{CHR}')_r\text{O}(\text{CHR}')_r\text{R}^{15\text{d}}$,
 $(\text{CHR}')_r\text{SH}$, $(\text{CHR}')_r\text{C}(\text{O})\text{H}$, $(\text{CHR}')_r\text{S}(\text{CHR}')_r\text{R}^{15\text{d}}$,
 $(\text{CHR}')_r\text{C}(\text{O})\text{OH}$, $(\text{CHR}')_r\text{C}(\text{O})(\text{CHR}')_r\text{R}^{15\text{b}}$,
 25 $(\text{CHR}')_r\text{C}(\text{O})\text{NR}^{15\text{a}}\text{R}^{15\text{a}'}$, $(\text{CHR}')_r\text{NR}^{15\text{f}}\text{C}(\text{O})(\text{CHR}')_r\text{R}^{15\text{b}}$,
 $(\text{CHR}')_r\text{NR}^{15\text{f}}\text{C}(\text{O})\text{NR}^{15\text{f}}\text{R}^{15\text{f}}$, $(\text{CHR}')_r\text{C}(\text{O})\text{O}(\text{CHR}')_r\text{R}^{15\text{d}}$,
 $(\text{CHR}')_r\text{OC}(\text{O})(\text{CHR}')_r\text{R}^{15\text{b}}$, $(\text{CHR}')_r\text{C}(=\text{NR}^{15\text{f}})\text{NR}^{15\text{a}}\text{R}^{15\text{a}'}$,
 $(\text{CHR}')_r\text{NHC}(=\text{NR}^{15\text{f}})\text{NR}^{15\text{f}}\text{R}^{15\text{f}}$, $(\text{CHR}')_r\text{S}(\text{O})_p(\text{CHR}')_r\text{R}^{15\text{b}}$,
 $(\text{CHR}')_r\text{S}(\text{O})_2\text{NR}^{15\text{a}}\text{R}^{15\text{a}'}$, $(\text{CHR}')_r\text{NR}^{15\text{f}}\text{S}(\text{O})_2(\text{CHR}')_r\text{R}^{15\text{b}}$, C_{1-6}
 30 haloalkyl, C_{2-8} alkenyl substituted with 0-3 R' , C_{2-8}
 alkynyl substituted with 0-3 R' , $(\text{CHR}')_r$ phenyl
 substituted with 0-3 $\text{R}^{15\text{e}}$, and a $(\text{CH}_2)_{r-5-10}$ membered
 heterocyclic system containing 1-4 heteroatoms
 selected from N, O, and S, substituted with 0-2 $\text{R}^{15\text{e}}$;
- 35

- R', at each occurrence, is selected from H, C₁₋₆ alkyl, C₂₋₈ alkenyl, C₂₋₈ alkynyl, (CH₂)_rC₃₋₆ cycloalkyl, and (CH₂)_rphenyl substituted with R^{15e};
- 5 R^{15a} and R^{15a'}, at each occurrence, are selected from H, C₁₋₆ alkyl, C₂₋₈ alkenyl, C₂₋₈ alkynyl, a (CH₂)_r-C₃₋₁₀ carbocyclic residue substituted with 0-5 R^{15e}, and a (CH₂)_r-5-10 membered heterocyclic system containing 1-4 heteroatoms selected from N, O, and S, substituted
- 10 with 0-2 R^{15e};
- R^{15b}, at each occurrence, is selected from C₁₋₆ alkyl, C₂₋₈ alkenyl, C₂₋₈ alkynyl, a (CH₂)_r-C₃₋₆ carbocyclic residue substituted with 0-3 R^{15e}, and (CH₂)_r-5-6 membered
- 15 heterocyclic system containing 1-4 heteroatoms selected from N, O, and S, substituted with 0-2 R^{15e};
- R^{15d}, at each occurrence, is selected from C₂₋₈ alkenyl, C₂₋₈ alkynyl, C₁₋₆ alkyl substituted with 0-3 R^{15e}, a
- 20 (CH₂)_r-C₃₋₁₀ carbocyclic residue substituted with 0-3 R^{15e}, and a (CH₂)_r-5-6 membered heterocyclic system containing 1-4 heteroatoms selected from N, O, and S, substituted with 0-3 R^{15e};
- 25 R^{15e}, at each occurrence, is selected from C₁₋₆ alkyl, C₂₋₈ alkenyl, C₂₋₈ alkynyl, (CH₂)_rC₃₋₆ cycloalkyl, Cl, F, Br, I, CN, NO₂, (CF₂)_rCF₃, (CH₂)_rOC₁₋₅ alkyl, OH, SH, (CH₂)_rSC₁₋₅ alkyl, (CH₂)_rNR^{15f}R^{15f}, and (CH₂)_rphenyl;
- 30 R^{15f}, at each occurrence, is selected from H, C₁₋₆ alkyl, C₃₋₆ cycloalkyl, and phenyl;
- R¹⁶, at each occurrence, is selected from C₁₋₈ alkyl, C₂₋₈ alkenyl, C₂₋₈ alkynyl, (CH₂)_rC₃₋₆ cycloalkyl, Cl, Br, I,
- 35 F, NO₂, CN, (CHR')_rNR^{16a}R^{16a'}, (CHR')_rOH, (CHR')_rO(CHR')_rR^{16d}, (CHR')_rSH, (CHR')_rC(O)H, (CHR')_rS(CHR')_rR^{16d}, (CHR')_rC(O)OH,

- $(\text{CHR}')_r\text{C}(\text{O})(\text{CHR}')_r\text{R}^{16b}$, $(\text{CHR}')_r\text{C}(\text{O})\text{NR}^{16a}r^{16a'}$,
 $(\text{CHR}')_r\text{NR}^{16f}\text{C}(\text{O})(\text{CHR}')_r\text{R}^{16b}$, $(\text{CHR}')_r\text{C}(\text{O})\text{O}(\text{CHR}')_r\text{R}^{16d}$,
 $(\text{CHR}')_r\text{OC}(\text{O})(\text{CHR}')_r\text{R}^{16b}$, $(\text{CHR}')_r\text{C}(=\text{NR}^{16f})\text{NR}^{16a}r^{16a'}$,
 $(\text{CHR}')_r\text{NHC}(=\text{NR}^{16f})\text{NR}^{16f}r^{16f}$, $(\text{CHR}')_r\text{S}(\text{O})_p(\text{CHR}')_r\text{R}^{16b}$,
 $(\text{CHR}')_r\text{S}(\text{O})_2\text{NR}^{16a}r^{16a'}$, $(\text{CHR}')_r\text{NR}^{16f}\text{S}(\text{O})_2(\text{CHR}')_r\text{R}^{16b}$, C₁₋₆
 5 haloalkyl, C₂₋₈ alkenyl substituted with 0-3 R', C₂₋₈
 alkynyl substituted with 0-3 R', and (CHR')_rphenyl
 substituted with 0-3 R^{16e};
- 10 R^{16a} and R^{16a'}, at each occurrence, are selected from H, C₁₋₆
 alkyl, C₂₋₈ alkenyl, C₂₋₈ alkynyl, a (CH₂)_r-C₃₋₁₀
 carbocyclic residue substituted with 0-5 R^{16e}, and a
 (CH₂)_r-5-10 membered heterocyclic system containing 1-4
 heteroatoms selected from N, O, and S, substituted
 15 with 0-2 R^{16e};
- R^{16b}, at each occurrence, is selected from C₁₋₆ alkyl, C₂₋₈
 alkenyl, C₂₋₈ alkynyl, a (CH₂)_r-C₃₋₆ carbocyclic residue
 substituted with 0-3 R^{16e}, and a (CH₂)_r-5-6 membered
 20 heterocyclic system containing 1-4 heteroatoms
 selected from N, O, and S, substituted with 0-2 R^{16e};
- R^{16d}, at each occurrence, is selected from C₂₋₈ alkenyl, C₂₋₈
 alkynyl, C₁₋₆ alkyl substituted with 0-3 R^{16e}, a
 25 (CH₂)_r-C₃₋₁₀ carbocyclic residue substituted with 0-3
 R^{16e}, and a (CH₂)_r-5-6 membered heterocyclic system
 containing 1-4 heteroatoms selected from N, O, and S,
 substituted with 0-3 R^{16e};
- 30 R^{16e}, at each occurrence, is selected from C₁₋₆ alkyl, C₂₋₈
 alkenyl, C₂₋₈ alkynyl, (CH₂)_r-C₃₋₆ cycloalkyl, Cl, F, Br,
 I, CN, NO₂, (CF₂)_r-CF₃, (CH₂)_r-OC₁₋₅ alkyl, OH, SH,
 (CH₂)_r-SC₁₋₅ alkyl, (CH₂)_r-NR^{16f}r^{16f}, and (CH₂)_rphenyl;
- 35 R^{16f}, at each occurrence, is selected from H, C₁₋₅ alkyl,
 and C₃₋₆ cycloalkyl, and phenyl;

v is selected from 0, 1, and 2;

t is selected from 1 and 2;

5 w is selected from 0 and 1;

r is selected from 0, 1, 2, 3, 4, and 5;

10 q is selected from 1, 2, 3, 4, and 5; and

p is selected from 1, 2, and 3.

[20] In a preferred embodiment, the present invention provides novel compounds of formula (I), wherein:

15

R⁴ is absent, taken with the nitrogen to which it is attached to form an N-oxide, or selected from C₁₋₈ alkyl, (CH₂)_rC₃₋₆ cycloalkyl, and (CH₂)_r-phenyl substituted with 0-3 R^{4c};

20

R^{4c}, at each occurrence, is selected from C₁₋₆ alkyl, C₂₋₈ alkenyl, C₂₋₈ alkynyl, C₃₋₆ cycloalkyl, Cl, F, Br, I, CN, NO₂, (CF₂)_rCF₃, (CH₂)_rOC₁₋₅ alkyl, (CH₂)_rOH, (CH₂)_rSC₁₋₅ alkyl, (CH₂)_rNR^{4a}R^{4a'}, and (CH₂)_rphenyl;

25

alternatively, R⁴ joins with R⁷, R⁹, or R¹¹ to form a 5, 6 or 7 membered piperidinium spirocycle or pyrrolidinium spirocycle substituted with 0-3 R^a;

30

R¹ and R² are independently selected from H and C₁₋₄ alkyl;

35

R⁶, at each occurrence, is selected from C₁₋₄ alkyl, C₂₋₈ alkenyl, C₂₋₈ alkynyl, (CH₂)_rC₃₋₆ cycloalkyl, (CF₂)_rCF₃, CN, (CH₂)_rOH, (CH₂)_rOR^{6b}, (CH₂)_rC(O)R^{6b}, (CH₂)_rC(O)NR^{6a}R^{6a'}, (CH₂)_rNR^{6d}C(O)R^{6a}, and (CH₂)_tphenyl substituted with 0-3 R^{6c};

- R^{6a} and R^{6a'}, at each occurrence, are selected from H, C₁₋₆ alkyl, C₃₋₆ cycloalkyl, and phenyl substituted with 0-3 R^{6c};
- 5 R^{6b}, at each occurrence, is selected from C₁₋₆ alkyl, C₃₋₆ cycloalkyl, and phenyl substituted with 0-3 R^{6c};
- R^{6c}, at each occurrence, is selected from C₁₋₆ alkyl, C₃₋₆ cycloalkyl, Cl, F, Br, I, CN, NO₂, (CF₂)_rCF₃, (CH₂)_rOC₁₋₅ alkyl, (CH₂)_rOH, (CH₂)_rSC₁₋₅ alkyl, and (CH₂)_rNR^{6d}R^{6d};
- 10 R^{6d}, at each occurrence, is selected from H, C₁₋₆ alkyl, and C₃₋₆ cycloalkyl;
- 15 R⁷, is selected from H, C₁₋₃ alkyl, (CH₂)_rC₃₋₆ cycloalkyl, (CH₂)_qOH, (CH₂)_qOR^{7d}, (CH₂)_qNR^{7a}R^{7a'}, (CH₂)_rC(O)R^{7b}, (CH₂)_rC(O)NR^{7a}R^{7a'}, (CH₂)_qNR^{7a}C(O)R^{7a}, C₁₋₆ haloalkyl, (CH₂)_rphenyl with 0-2 R^{7c};
- 20 R^{7a} and R^{7a'}, at each occurrence, are selected from H, C₁₋₆ alkyl, (CH₂)_rC₃₋₆ cycloalkyl, a (CH₂)_rphenyl substituted with 0-3 R^{7e};
- R^{7b}, at each occurrence, is selected from C₁₋₆ alkyl, C₂₋₈ alkenyl, C₂₋₈ alkynyl, (CH₂)_rC₃₋₆ cycloalkyl, (CH₂)_rphenyl substituted with 0-3 R^{7e};
- 25 R^{7c}, at each occurrence, is selected from C₁₋₄ alkyl, C₂₋₈ alkenyl, C₂₋₈ alkynyl, (CH₂)_rC₃₋₆ cycloalkyl, Cl, Br, I, F, (CF₂)_rCF₃, NO₂, CN, (CH₂)_rNR^{7f}R^{7f}, (CH₂)_rOH, (CH₂)_rOC₁₋₄ alkyl, (CH₂)_rC(O)R^{7b}, (CH₂)_rC(O)NR^{7f}R^{7f}, (CH₂)_rNR^{7f}C(O)R^{7a}, (CH₂)_rS(O)_pR^{7b}, (CH₂)_rS(O)₂NR^{7f}R^{7f}, (CH₂)_rNR^{7f}S(O)₂R^{7b}, and (CH₂)_rphenyl substituted with 0-2 R^{7e};
- 30
- 35

- R^{7d}, at each occurrence, is selected from C₁₋₆ alkyl, (CH₂)_rC₃₋₆ cycloalkyl, (CH₂)_rphenyl substituted with 0-3 R^{7e};
- 5 R^{7e}, at each occurrence, is selected from C₁₋₆ alkyl, C₂₋₈ alkenyl, C₂₋₈ alkynyl, C₃₋₆ cycloalkyl, Cl, F, Br, I, CN, NO₂, (CF₂)_rCF₃, (CH₂)_rOC₁₋₅ alkyl, OH, SH, (CH₂)_rSC₁₋₅ alkyl, (CH₂)_rNR^{7f}R^{7f}, and (CH₂)_rphenyl;
- 10 R^{7f}, at each occurrence, is selected from H, C₁₋₅ alkyl, and C₃₋₆ cycloalkyl;
- R⁸ is H or joins with R⁷ to form C₃₋₇ cycloalkyl or =NR^{8b};
- 15 R¹¹, is selected from H, C₁₋₆ alkyl, (CH₂)_rC₃₋₆ cycloalkyl, (CH₂)_qOH, (CH₂)_qOR^{11d}, (CH₂)_qNR^{11a}R^{11a'}, (CH₂)_rC(O)R^{11b}, (CH₂)_rC(O)NR^{11a}R^{11a'}, (CH₂)_qNR^{11a}C(O)R^{11a}, C₁₋₆ haloalkyl, (CH₂)_rphenyl with 0-2 R^{11c}, (CH₂)_{r-5-10} membered heterocyclic system containing 1-4 heteroatoms
- 20 selected from N, O, and S, substituted with 0-3 R¹⁵;
- R^{11a} and R^{11a'}, at each occurrence, are selected from H, C₁₋₆ alkyl, (CH₂)_rC₃₋₆ cycloalkyl, a (CH₂)_rphenyl substituted with 0-3 R^{11e};
- 25 R^{11b}, at each occurrence, is selected from C₁₋₆ alkyl, C₂₋₈ alkenyl, C₂₋₈ alkynyl, (CH₂)_rC₃₋₆ cycloalkyl, (CH₂)_rphenyl substituted with 0-3 R^{11e};
- 30 R^{11c}, at each occurrence, is selected from C₁₋₄ alkyl, C₂₋₈ alkenyl, C₂₋₈ alkynyl, (CH₂)_rC₃₋₆ cycloalkyl, Cl, Br, I, F, (CF₂)_rCF₃, NO₂, CN, (CH₂)_rNR^{11f}R^{11f}, (CH₂)_rOH, (CH₂)_rOC₁₋₄ alkyl, (CH₂)_rC(O)R^{11b}, (CH₂)_rC(O)NR^{11f}R^{11f}, (CH₂)_rNR^{11f}C(O)R^{11a}, (CH₂)_rS(O)_pR^{11b},
- 35 (CH₂)_rS(O)₂NR^{11f}R^{11f}, (CH₂)_rNR^{11f}S(O)₂R^{11b}, and (CH₂)_rphenyl substituted with 0-2 R^{11e};

- R^{11d} , at each occurrence, is selected from C_{1-6} alkyl, $(CH_2)_r C_{3-6}$ cycloalkyl, $(CH_2)_r$ phenyl substituted with 0-3 R^{11e} ;
- 5 R^{11e} , at each occurrence, is selected from C_{1-6} alkyl, C_{2-8} alkenyl, C_{2-8} alkynyl, C_{3-6} cycloalkyl, Cl, F, Br, I, CN, NO_2 , $(CF_2)_r CF_3$, $(CH_2)_r OC_{1-5}$ alkyl, OH, SH, $(CH_2)_r SC_{1-5}$ alkyl, $(CH_2)_r NR^{11f} R^{11f}$, and $(CH_2)_r$ phenyl;
- 10 R^{11f} , at each occurrence, is selected from H, C_{1-5} alkyl and C_{3-6} cycloalkyl;
- R^{12} is H or joins with R^{11} to form C_{3-7} cycloalkyl;
- 15 R^{13} , at each occurrence, is selected from C_{1-4} alkyl, C_{3-6} cycloalkyl, $(CH_2)NR^{13a}R^{13a'}$, $(CH_2)OH$, $(CH_2)OR^{13b}$, $(CH_2)_w C(O)R^{13b}$, $(CH_2)_w C(O)NR^{13a}R^{13a'}$, $(CH_2)NR^{13d}C(O)R^{13a}$, $(CH_2)_w S(O)_2 NR^{13a}R^{13a'}$, $(CH_2)NR^{13d}S(O)_2 R^{13b}$, and $(CH_2)_w$ -phenyl substituted with 0-3 R^{13c} ;
- 20 R^{13a} and $R^{13a'}$, at each occurrence, are selected from H, C_{1-6} alkyl, C_{3-6} cycloalkyl, and phenyl substituted with 0-3 R^{13c} ;
- 25 R^{13b} , at each occurrence, is selected from C_{1-6} alkyl, C_{3-6} cycloalkyl, and phenyl substituted with 0-3 R^{13c} ;
- R^{13c} , at each occurrence, is selected from C_{1-6} alkyl, C_{3-6} cycloalkyl, Cl, F, Br, I, CN, NO_2 , $(CF_2)_r CF_3$, $(CH_2)_r OC_{1-5}$ alkyl, $(CH_2)_r OH$, and $(CH_2)_r NR^{13d} R^{13d}$;
- 30 R^{13d} , at each occurrence, is selected from H, C_{1-6} alkyl, and C_{3-6} cycloalkyl;
- 35 v is selected from 1 and 2;
- q is selected from 1, 2, and 3; and

r is selected from 0, 1, 2, and 3.

[21] In a more preferred embodiment, the present invention
5 provides novel compounds of formula (I), wherein:

R³ is selected from a (CR^{3'}H)_r-carbocyclic residue
substituted with 0-5 R¹⁵, wherein the carbocyclic
residue is selected from phenyl, C₃₋₆ cycloalkyl,
10 naphthyl, and adamantyl; and a (CR^{3'}H)_r-heterocyclic
system substituted with 0-3 R¹⁵, wherein the
heterocyclic system is selected from pyridinyl,
thiophenyl, furanyl, indazolyl, benzothiazolyl,
benzimidazolyl, benzothiophenyl, benzofuranyl,
15 benzoxazolyl, benzisoxazolyl, quinolinyl,
isoquinolinyl, imidazolyl, indolyl, indolinyl,
isoindolyl, isothiadiazolyl, isoxazolyl, piperidinyl,
pyrrazolyl, 1,2,4-triazolyl, 1,2,3-triazolyl,
tetrazolyl, thiadiazolyl, thiazolyl, oxazolyl,
20 pyrazinyl, and pyrimidinyl; and

R⁵ is selected from (CR^{5'}H)_t-phenyl substituted with 0-5
R¹⁶; and a (CR^{5'}H)_t-heterocyclic system substituted
with 0-3 R¹⁶, wherein the heterocyclic system is
25 selected from pyridinyl, thiophenyl, furanyl,
indazolyl, benzothiazolyl, benzimidazolyl,
benzothiophenyl, benzofuranyl, benzoxazolyl,
benzisoxazolyl, quinolinyl, isoquinolinyl, imidazolyl,
indolyl, isoindolyl, piperidinyl, pyrrazolyl, 1,2,4-
30 triazolyl, 1,2,3-triazolyl, tetrazolyl, thiazolyl,
oxazolyl, pyrazinyl, and pyrimidinyl.

[22] In an even more preferred embodiment, the present
invention provides novel compounds of formula (I-i),
35 wherein the compound of formula (I-i) is:

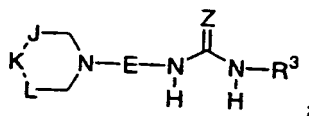

(I-i)

- 5 R^{16} , at each occurrence, is selected from C_{1-8} alkyl, $(CH_2)_r C_{3-6}$ cycloalkyl, CF_3 , Cl, Br, I, F, $(CH_2)_r NR^{16a}R^{16a'}$, NO_2 , CN, OH, $(CH_2)_r OR^{16d}$, $(CH_2)_r C(O)R^{16b}$, $(CH_2)_r C(O)NR^{16a}R^{16a'}$, $(CH_2)_r NR^{16f}C(O)R^{16b}$, $(CH_2)_r S(O)_p R^{16b}$, $(CH_2)_r S(O)_2 NR^{16a}R^{16a'}$, $(CH_2)_r NR^{16f}S(O)_2 R^{16b}$, and $(CH_2)_r$ phenyl substituted with 0-3 R^{16e} ;
- 10 R^{16a} and $R^{16a'}$, at each occurrence, are selected from H, C_{1-6} alkyl, C_{3-6} cycloalkyl, and $(CH_2)_r$ phenyl substituted with 0-3 R^{16e} ;
- 15 R^{16b} , at each occurrence, is selected from H, C_{1-6} alkyl, C_{3-6} cycloalkyl, and $(CH_2)_r$ phenyl substituted with 0-3 R^{16e} ;
- 20 R^{16d} , at each occurrence, is selected from C_{1-6} alkyl and phenyl;
- 25 R^{16e} , at each occurrence, is selected from C_{1-6} alkyl, Cl, F, Br, I, CN, NO_2 , $(CF_2)_r CF_3$, OH, and $(CH_2)_r OC_{1-5}$ alkyl; and
- R^{16f} , at each occurrence, is selected from H, and C_{1-5} alkyl.
- 30 [23] In another even more preferred embodiment, the present invention provides novel compounds of formula (I-ii), wherein the compound formula (I-ii) is:

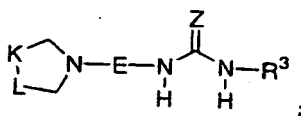

(I-ii)

- 5 R^{16} , at each occurrence, is selected from C_{1-8} alkyl,
 $(CH_2)_r C_{3-6}$ cycloalkyl, CF_3 , Cl, Br, I, F,
 $(CH_2)_r NR^{16a} R^{16a'}$, NO_2 , CN, OH, $(CH_2)_r OR^{16d}$,
 $(CH_2)_r C(O)R^{16b}$, $(CH_2)_r C(O)NR^{16a} R^{16a'}$, $(CH_2)_r NR^{16f} C(O)R^{16b}$,
 $(CH_2)_r S(O)_p R^{16b}$, $(CH_2)_r S(O)_2 NR^{16a} R^{16a'}$,
 $(CH_2)_r NR^{16f} S(O)_2 R^{16b}$, and $(CH_2)_r$ phenyl substituted with
 0-3 R^{16e} ;
 10 R^{16a} and $R^{16a'}$, at each occurrence, are selected from H, C_{1-6}
 alkyl, C_{3-6} cycloalkyl, and $(CH_2)_r$ phenyl substituted
 with 0-3 R^{16e} ;
 15 R^{16b} , at each occurrence, is selected from H, C_{1-6} alkyl,
 C_{3-6} cycloalkyl, and $(CH_2)_r$ phenyl substituted with 0-3
 R^{16e} ;
 R^{16d} , at each occurrence, is selected from C_{1-6} alkyl and
 20 phenyl;
 R^{16e} , at each occurrence, is selected from C_{1-6} alkyl, Cl,
 F, Br, I, CN, NO_2 , $(CF_2)_r CF_3$, OH, and $(CH_2)_r OC_{1-5}$ alkyl;
 and
 25 R^{16f} , at each occurrence, is selected from H, and C_{1-5}
 alkyl.

[24] In a preferred embodiment, the present invention
 30 provides novel compounds of formula (I-i) wherein:

R^5 is CH_2 phenyl substituted with 0-3 R^{16} ;

E is $-CH_2-(CR^9 R^{10})-(CR^{11} R^{12})$;

35 R^9 , is selected from H, C_{1-6} alkyl, $(CH_2)_r C_{3-6}$ cycloalkyl, F,
 Cl, CN, $(CH_2)_r OH$, $(CH_2)_r OR^{9d}$, $(CH_2)_r NR^{9a} R^{9a'}$,

- (CH₂)_rOC(O)NHR^{9a}, (CH₂)_rphenyl substituted with 0-5 R^{9e},
and a heterocyclic system substituted with 0-2 R^{9e},
wherein the heterocyclic system is selected from
pyridyl, thiophenyl, furanyl, oxazolyl, and thiazolyl;
- 5 R^{9a} and R^{9a'}, at each occurrence, are selected from H, C₁₋₆
alkyl, C₃₋₆ cycloalkyl, and (CH₂)_rphenyl substituted
with 0-3 R^{9e};
- 10 R^{9d}, at each occurrence, is selected from C₁₋₆ alkyl and
phenyl;
- R^{9e}, at each occurrence, is selected from C₁₋₆ alkyl, Cl, F,
Br, I, CN, NO₂, (CF₂)_rCF₃, OH, and (CH₂)_rOC₁₋₅ alkyl;
- 15 R¹⁰ is selected from H, C₁₋₅ alkyl, OH, and CH₂OH;
- alternatively, R⁹ and R¹⁰ join to form C₃₋₇ cycloalkyl, 5-6-
membered cyclic ketal or =O;
- 20 with the proviso that when R¹⁰ is -OH, R⁹ is not halogen,
cyano, or bonded to the carbon to which it is attached
through a heteroatom;
- 25 R¹¹ is selected from H, C₁₋₈ alkyl, (CH₂)_rphenyl substituted
with 0-5 R^{11e}, and a (CH₂)_r-heterocyclic system
substituted with 0-2 R^{11e}, wherein the heterocyclic
system is selected from pyridinyl, thiophenyl,
furanyl, indazolyl, benzothiazolyl, benzimidazolyl,
30 benzothiophenyl, benzofuranyl, benzoxazolyl,
benzisoxazolyl, quinolinyl, isoquinolinyl, imidazolyl,
indolyl, isoindolyl, piperidinyl, pyrazolyl, 1,2,4-
triazolyl, 1,2,3-triazolyl, tetrazolyl, thiazolyl,
oxazolyl, pyrazinyl, and pyrimidinyl; and
- 35 R^{11e}, at each occurrence, is selected from C₁₋₆ alkyl, Cl,
F, Br, I, CN, NO₂, (CF₂)_rCF₃, OH, and (CH₂)_rOC₁₋₅ alkyl;

R¹² is H;

alternatively, R¹¹ and R¹² join to form C₃₋₇ cycloalkyl; and

5

r is selected from 0, 1, and 2.

[25]. In another preferred embodiment, the present invention provides novel compounds of formula (I-ii),

10

wherein:

R⁵ is CH₂phenyl substituted with 0-3 R¹⁶;

E is -CH₂-(CR⁹R¹⁰)-(CR¹¹R¹²);

15

R⁹, is selected from H, C₁₋₆ alkyl, (CH₂)_rC₃₋₆ cycloalkyl, F, Cl, CN, (CH₂)_rOH, (CH₂)_rOR^{9d}, (CH₂)_rNR^{9a}R^{9a'}, (CH₂)_rOC(O)NHR^{9a}, (CH₂)_rphenyl substituted with 0-5 R^{9e}, and a heterocyclic system substituted with 0-2 R^{9e}, wherein the heterocyclic system is selected from pyridyl, thiophenyl, furanyl, oxazolyl, and thiazolyl;

20

R^{9a} and R^{9a'}, at each occurrence, are selected from H, C₁₋₆ alkyl, C₃₋₆ cycloalkyl, and (CH₂)_rphenyl substituted with 0-3 R^{9e};

25

R^{9d}, at each occurrence, is selected from C₁₋₆ alkyl and phenyl;

30

R^{9e}, at each occurrence, is selected from C₁₋₆ alkyl, Cl, F, Br, I, CN, NO₂, (CF₂)_rCF₃, OH, and (CH₂)_rOC₁₋₅ alkyl;

R¹⁰ is selected from H, C₁₋₈ alkyl, OH, and CH₂OH;

alternatively, R⁹ and R¹⁰ join to form C₃₋₇ cycloalkyl, 5-6-membered cyclic ketal or =O;

35

with the proviso that when R¹⁰ is -OH, R⁹ is not halogen, cyano, or bonded to the carbon to which it is attached through a heteroatom;

5 R¹¹ is selected from H, C₁₋₈ alkyl, (CH₂)_rphenyl substituted with 0-5 R^{11e}, and a (CH₂)_r-heterocyclic system substituted with 0-2 R^{11e}, wherein the heterocyclic system is selected from pyridinyl, thiophenyl, furanyl, indazolyl, benzothiazolyl, benzimidazolyl, 10 benzothiophenyl, benzofuranyl, benzoxazolyl, benzisoxazolyl, quinolinyl, isoquinolinyl, imidazolyl, indolyl, isoindolyl, piperidinyl, pyrrolazolyl, 1,2,4-triazolyl, 1,2,3-triazolyl, tetrazolyl, thiazolyl, oxazolyl, pyrazinyl, and pyrimidinyl; and

15 R^{11e}, at each occurrence, is selected from C₁₋₆ alkyl, Cl, F, Br, I, CN, NO₂, (CF₂)_rCF₃, OH, and (CH₂)_rOC₁₋₅ alkyl;

R¹² is H;

20 alternatively, R¹¹ and R¹² join to form C₃₋₇ cycloalkyl; and

r is selected from 0, 1, and 2.

25 [26] In a more preferred embodiment, the present invention provides novel compounds of formula (I-i), wherein:

J is selected from CH₂ and CHR⁵;

30 K is selected from CH₂ and CHR⁵;

L is selected from CH₂ and CHR⁵;

35 R³ is a C₃₋₁₀ carbocyclic residue substituted with 0-3 R¹⁵, wherein the carbocyclic residue is selected from cyclopropyl, cyclopentyl, cyclohexyl, phenyl, naphthyl and adamantyl, and a (CR^{3'H})_r-heterocyclic system

substituted with 0-3 R¹⁵, wherein the heterocyclic system is selected from pyridinyl, thiophenyl, furanyl, indazolyl, benzothiazolyl, benzimidazolyl, benzothiophenyl, benzofuranyl, benzoxazolyl, benzisoxazolyl, quinolinyl, isoquinolinyl, imidazolyl, indolyl, indolinyl, isoindolyl, isothiadiazolyl, isoxazolyl, piperidinyl, pyrazolyl, 1,2,4-triazolyl, 1,2,3-triazolyl, tetrazolyl, thiadiazolyl, thiazolyl, oxazolyl, pyrazinyl, and pyrimidinyl; and

R¹⁵, at each occurrence, is selected from C₁₋₈ alkyl, (CH₂)_rC₃₋₆ cycloalkyl, CF₃, Cl, Br, I, F, (CH₂)_rNR^{15a}R^{15a'}, NO₂, CN, OH, (CH₂)_rOR^{15d}, (CH₂)_rC(O)R^{15b}, (CH₂)_rC(O)NR^{15a}R^{15a'}, (CH₂)_rNR^{15f}C(O)R^{15b}, (CH₂)_rS(O)_pR^{15b}, (CH₂)_rS(O)₂NR^{15a}R^{15a'}, (CH₂)_rNR^{15f}S(O)₂R^{15b}, (CH₂)_rphenyl substituted with 0-3 R^{15e}, and a (CH₂)_r-5-6 membered heterocyclic system containing 1-4 heteroatoms selected from N, O, and S, substituted with 0-2 R^{15e};

R^{15a} and R^{15a'}, at each occurrence, are selected from H, C₁₋₆ alkyl, C₃₋₆ cycloalkyl, and (CH₂)_rphenyl substituted with 0-3 R^{15e};

R^{15b}, at each occurrence, is selected from H, C₁₋₆ alkyl, C₃₋₆ cycloalkyl, and (CH₂)_rphenyl substituted with 0-3 R^{15e};

R^{15d}, at each occurrence, is selected from C₁₋₆ alkyl and phenyl;

R^{15e}, at each occurrence, is selected from C₁₋₆ alkyl, Cl, F, Br, I, CN, NO₂, (CF₂)_rCF₃, OH, and (CH₂)_rOC₁₋₅ alkyl; and

R^{15f}, at each occurrence, is selected from H, and C₁₋₅ alkyl.

[27] In another more preferred embodiment, the present invention provides novel compounds of formula (I-ii), wherein:

- 5
K is selected from CH_2 and CHR^5 ;
- L is selected from CH_2 and CHR^5 ;
- 10 R^3 is a C_3 -10 carbocyclic residue substituted with 0-3 R^{15} , wherein the carbocyclic residue is selected from cyclopropyl, cyclopentyl, cyclohexyl, phenyl, naphthyl and adamantyl, and a $(\text{CR}^{3'}\text{H})_r$ -heterocyclic system substituted with 0-3 R^{15} , wherein the heterocyclic
- 15 system is selected from pyridinyl, thiophenyl, furanyl, indazolyl, benzothiazolyl, benzimidazolyl, benzothiophenyl, benzofuranyl, benzoxazolyl, benzisoxazolyl, quinolinyl, isoquinolinyl, imidazolyl, indolyl, indolinyl, isoindolyl, isothiadiazolyl,
- 20 isoxazolyl, piperidinyl, pyrazolyl, 1,2,4-triazolyl, 1,2,3-triazolyl, tetrazolyl, thiadiazolyl, thiazolyl, oxazolyl, pyrazinyl, and pyrimidinyl; and
- R^{15} , at each occurrence, is selected from C_{1-8} alkyl,
- 25 $(\text{CH}_2)_r\text{C}_{3-6}$ cycloalkyl, CF_3 , Cl, Br, I, F, $(\text{CH}_2)_r\text{NR}^{15a}\text{R}^{15a'}$, NO_2 , CN, OH, $(\text{CH}_2)_r\text{OR}^{15d}$, $(\text{CH}_2)_r\text{C}(\text{O})\text{R}^{15b}$, $(\text{CH}_2)_r\text{C}(\text{O})\text{NR}^{15a}\text{R}^{15a'}$, $(\text{CH}_2)_r\text{NR}^{15f}\text{C}(\text{O})\text{R}^{15b}$, $(\text{CH}_2)_r\text{S}(\text{O})_p\text{R}^{15b}$, $(\text{CH}_2)_r\text{S}(\text{O})_2\text{NR}^{15a}\text{R}^{15a'}$,
- 30 $(\text{CH}_2)_r\text{NR}^{15f}\text{S}(\text{O})_2\text{R}^{15b}$, $(\text{CH}_2)_r$ phenyl substituted with 0-3 R^{15e} , and a $(\text{CH}_2)_r$ -5-6 membered heterocyclic system containing 1-4 heteroatoms selected from N, O, and S, substituted with 0-2 R^{15e} ;
- R^{15a} and $\text{R}^{15a'}$, at each occurrence, are selected from H, C_{1-6}
- 35 alkyl, C_{3-6} cycloalkyl, and $(\text{CH}_2)_r$ phenyl substituted with 0-3 R^{15e} ;

R^{15b}, at each occurrence, is selected from H, C₁₋₆ alkyl, C₃₋₆ cycloalkyl, and (CH₂)_rphenyl substituted with 0-3 R^{15e};

5 R^{15d}, at each occurrence, is selected from C₁₋₆ alkyl and phenyl;

R^{15e}, at each occurrence, is selected from C₁₋₆ alkyl, Cl, F, Br, I, CN, NO₂, (CF₂)_rCF₃, OH, and (CH₂)_rOC₁₋₅ alkyl;
10 and

R^{15f}, at each occurrence, is selected from H, and C₁₋₅ alkyl.

15 [28] In a further even more preferred embodiment, the present invention provides novel compounds of formula (I) and pharmaceutically acceptable salt forms thereof, wherein the compound of formula I is selected from:

20 N^{''}-cyano-N-(3-methoxyphenyl)-N'-[3-[4-(phenylmethyl)-1-piperidinyl]propyl]guanidine,
N^{''}-cyano-N-(3-methoxyphenyl)-N'-[3-[4-(4-fluorophenylmethyl)-1-piperidinyl]propyl]guanidine.

25 N-(3-acetylphenyl)-N^{''}-cyano-N'-[3-[4-(4-fluorophenylmethyl)-1-piperidinyl]propyl]guanidine,

N-(3-acetylphenyl)-N^{''}-cyano-N'-[3-[(3S)-3-(4-fluorobenzyl)piperidinyl]propyl]guanidine,
30

N^{''}-cyano-N-(3,5-diacetylphenyl)-N'-[3-[(3S)-3-(4-fluorobenzyl)piperidinyl]propyl]guanidine,

35 N^{''}-cyano-N-[3-[(3S)-3-(4-fluorobenzyl)piperidinyl]propyl]-N'-[3-(1-methyl-1H-tetrazol-5-yl)phenyl]guanidine,

N^{''}-cyano-N-(2,4-dimethoxyphenyl)-N'-[3-[(3S)-3-(4-fluorobenzyl)piperidinyl]propyl]guanidine,

- N*-(5-acetyl-2-methoxyphenyl)-*N*"-cyano-*N*'-{3-[(3*S*)-3-(4-fluorobenzyl)piperidinyl]propyl}guanidine,
- 5 *N*-(3-acetylphenyl)-*N*"-cyano-*N*'-{(3*R*, 4*R*)-5-[4-(4-fluorobenzyl)piperidinyl]-4-hydroxy-1-methyl-3-pentyl}guanidine,
- 10 *N*"-cyano-*N*'-{3-[(3*S*)-3-(4-fluorobenzyl)piperidinyl]-2-(2*E*)-propenyl}-*N*'-[3-(1-methyl-1*H*-tetrazol-5-yl)phenyl]guanidine,
- 15 2-[(3-acetylanilino)({3-[(4-(4-fluorobenzyl)piperidinyl]propyl)amino)methylene]malononitrile,
- 20 2-[(3-acetylanilino)({3-[(3*S*)-3-(4-fluorobenzyl)piperidinyl]propyl)amino)methylene]malononitrile,
- 25 *N*-[(*E*)-(3-acetylanilino)({3-[(3*S*)-3-(4-fluorobenzyl)piperidinyl]propyl)amino)methylidene]urea
- 30 *N*-[(*E*)-(3,5-diacetylanilino)({3-[(3*S*)-3-(4-fluorobenzyl)piperidinyl]propyl)amino)methylidene]urea
- 35 *N*-[(*E*)-[3-(1-methyl-1*H*-tetrazol-5-yl)anilino]({3-[(3*S*)-3-(4-fluorobenzyl)piperidinyl]propyl)amino)methylidene]urea

Methyl (*E*)-(3,5-diacetylanilino)((3-[(3*S*)-3-(4-fluorobenzyl)piperidinyl]propyl)amino)methylidene-carbamate,

5 1-(3-[(*E*)-1-((3-[4-(4-fluorobenzyl)piperidinyl]propyl)amino)-2-nitroethenyl]amino)phenyl)ethanone, and

10 1-(3-[(*E*)-1-((3-[(3*S*)-3-(4-fluorobenzyl)piperidinyl]propyl)amino)-2-nitroethenyl]amino)phenyl)ethanone.

15

[29] In another embodiment, the present invention provides novel compounds of formula (I):

20

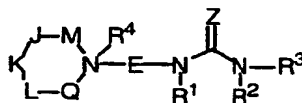

(I)

or stereoisomers or pharmaceutically acceptable salts thereof, wherein:

25 M is absent or selected from CH₂, CHR⁵, CHR¹³, CR¹³R¹³, and CR⁵R¹³;

Q is selected from CH₂, CHR⁵, CHR¹³, CR¹³R¹³, and CR⁵R¹³;

30 J, K, and L are independently selected from CH₂, CHR⁵, CHR⁶, CR⁶R⁶ and CR⁵R⁶;

with the provisos:

35 1) at least one of M, J, K, L, or Q contains an R⁵;
and

2) when M is absent, J is selected from CH_2 , CHR^5 , CHR^{13} , and CR^5R^{13} ;

5 Z is selected from NR^{1a} , CHCN , CHNO_2 , and $\text{C}(\text{CN})_2$;

R^{1a} is selected from H, C_{1-6} alkyl, C_{3-6} cycloalkyl, $\text{CONR}^{1b}\text{R}^{1b}$, OR^{1b} , CN, NO_2 , and $(\text{CH}_2)_w\text{phenyl}$;

10 R^{1b} is independently selected from H, C_{1-3} alkyl, C_{3-6} cycloalkyl, and phenyl;

E is selected from:

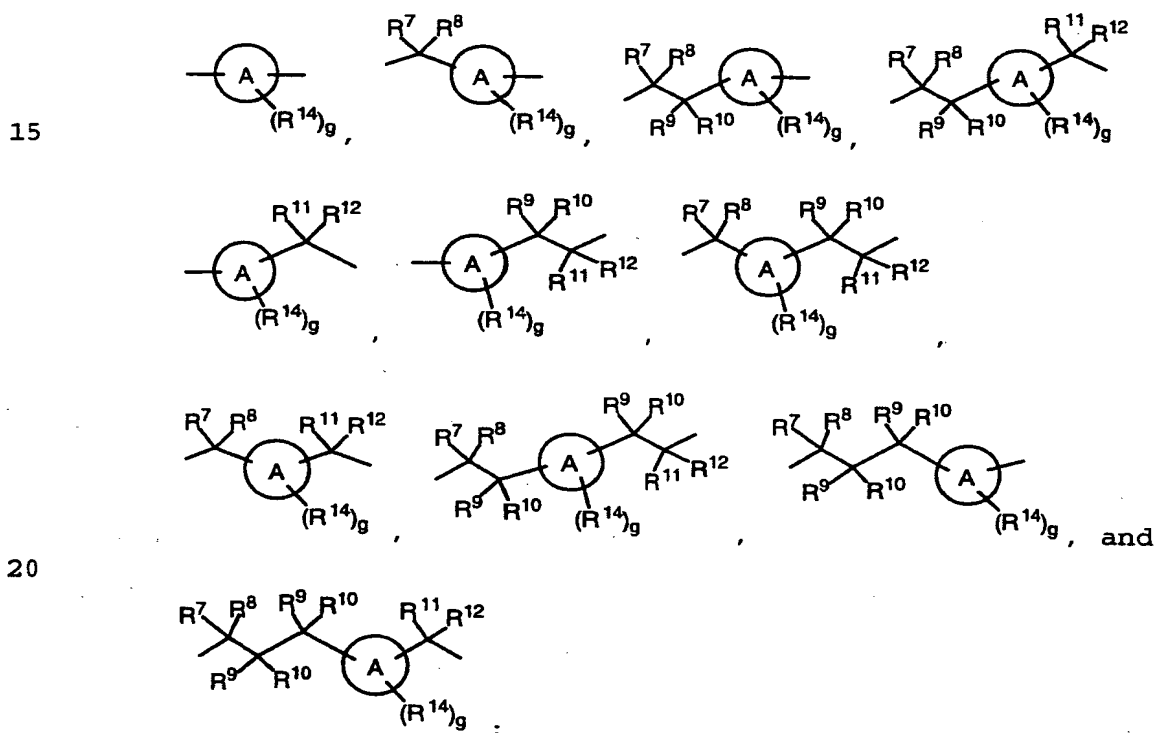

ring A is a C_{3-6} carbocyclic residue;

25 R^1 and R^2 are independently selected from H, C_{1-6} alkyl, C_{2-8} alkenyl, C_{2-8} alkynyl, $(\text{CH}_2)_r\text{C}_{3-6}$ cycloalkyl, and a

(CH₂)_r-C₃₋₁₀ carbocyclic residue substituted with 0-5 R^a;

5 R^a, at each occurrence, is selected from C₁₋₆ alkyl, C₂₋₈ alkenyl, C₂₋₈ alkynyl, (CH₂)_r-C₃₋₆ cycloalkyl, Cl, Br, I, F, (CF₂)_rCF₃, NO₂, CN, (CH₂)_rNR^bR^b, (CH₂)_rOH, (CH₂)_rOR^c, (CH₂)_rSH, (CH₂)_rSR^c, (CH₂)_rC(O)R^b, (CH₂)_rC(O)NR^bR^b, (CH₂)_rNR^bC(O)R^b, (CH₂)_rC(O)OR^b, (CH₂)_rOC(O)R^c, (CH₂)_rCH(=NR^b)NR^bR^b, (CH₂)_rNHC(=NR^b)NR^bR^b, (CH₂)_rS(O)_pR^c, 10 (CH₂)_rS(O)₂NR^bR^b, (CH₂)_rNR^bS(O)₂R^c, and (CH₂)_rphenyl;

R^b, at each occurrence, is selected from H, C₁₋₆ alkyl, C₃₋₆ cycloalkyl, and phenyl;

15 R^c, at each occurrence, is selected from C₁₋₆ alkyl, C₃₋₆ cycloalkyl, and phenyl;

alternatively, R² and R³ join to form a 5, 6, or 7-membered ring substituted with 0-3 R^a;

20 R³ is selected from a (CR^{3'}R^{3''})_r-C₃₋₁₀ carbocyclic residue substituted with 0-5 R¹⁵ and a (CR^{3'}R^{3''})_r-5-10 membered heterocyclic system containing 1-4 heteroatoms selected from N, O, and S, substituted with 0-3 R¹⁵;

25 R^{3'} and R^{3''}, at each occurrence, are selected from H, C₁₋₆ alkyl, (CH₂)_r-C₃₋₆ cycloalkyl, and phenyl;

30 R⁴ is absent, taken with the nitrogen to which it is attached to form an N-oxide, or selected from C₁₋₆ alkyl, C₂₋₈ alkenyl, C₂₋₈ alkynyl, (CH₂)_r-C₃₋₆ cycloalkyl, (CH₂)_qC(O)R^{4b}, (CH₂)_qC(O)NR^{4a}R^{4a'}, (CH₂)_qC(O)OR^{4b}, and a (CH₂)_r-C₃₋₁₀ carbocyclic residue substituted with 0-3 R^{4c};

35 R^{4a} and R^{4a'}, at each occurrence, are selected from H, C₁₋₆ alkyl, (CH₂)_r-C₃₋₆ cycloalkyl, and phenyl;

- R^{4b} , at each occurrence, is selected from C_{1-6} alkyl, C_{2-8} alkenyl, $(CH_2)_r C_{3-6}$ cycloalkyl, C_{2-8} alkynyl, and phenyl;
- 5
- R^{4c} , at each occurrence, is selected from C_{1-6} alkyl, C_{2-8} alkenyl, C_{2-8} alkynyl, C_{3-6} cycloalkyl, Cl, F, Br, I, CN, NO_2 , $(CF_2)_r CF_3$, $(CH_2)_r OC_{1-5}$ alkyl, $(CH_2)_r OH$, $(CH_2)_r SC_{1-5}$ alkyl, $(CH_2)_r NR^{4a}R^{4a'}$, and $(CH_2)_r$ phenyl;
- 10
- alternatively, R^4 joins with R^7 , R^9 , or R^{11} to form a 5, 6 or 7 membered piperidinium spirocycle or pyrrolidinium spirocycle substituted with 0-3 R^a ;
- 15
- R^5 is selected from a $(CR^{5'}R^{5''})_{t-C_{3-10}}$ carbocyclic residue substituted with 0-5 R^{16} and a $(CR^{5'}R^{5''})_{t-5-10}$ membered heterocyclic system containing 1-4 heteroatoms selected from N, O, and S, substituted with 0-3 R^{16} ;
- 20
- $R^{5'}$ and $R^{5''}$, at each occurrence, are selected from H, C_{1-6} alkyl, $(CH_2)_r C_{3-6}$ cycloalkyl, and phenyl;
- R^6 , at each occurrence, is selected from C_{1-6} alkyl, C_{2-8} alkenyl, C_{2-8} alkynyl, $(CH_2)_r C_{3-6}$ cycloalkyl, $(CF_2)_r CF_3$,
- 25
- CN , $(CH_2)_r NR^{6a}R^{6a'}$, $(CH_2)_r OH$, $(CH_2)_r OR^{6b}$, $(CH_2)_r SH$, $(CH_2)_r SR^{6b}$, $(CH_2)_r C(O)OH$, $(CH_2)_r C(O)R^{6b}$, $(CH_2)_r C(O)NR^{6a}R^{6a'}$, $(CH_2)_r NR^{6d}C(O)R^{6a}$, $(CH_2)_r C(O)OR^{6b}$, $(CH_2)_r OC(O)R^{6b}$, $(CH_2)_r S(O)_p R^{6b}$, $(CH_2)_r S(O)_2 NR^{6a}R^{6a'}$, $(CH_2)_r NR^{6d}S(O)_2 R^{6b}$, and $(CH_2)_t$ phenyl substituted with 0-3 R^{6c} ;
- 30
- R^{6a} and $R^{6a'}$, at each occurrence, are selected from H, C_{1-6} alkyl, C_{3-6} cycloalkyl, and phenyl substituted with 0-3 R^{6c} ;
- 35
- R^{6b} , at each occurrence, is selected from C_{1-6} alkyl, C_{3-6} cycloalkyl, and phenyl substituted with 0-3 R^{6c} ;

- 5 R^{6c} , at each occurrence, is selected from C_{1-6} alkyl, C_{3-6} cycloalkyl, Cl, F, Br, I, CN, NO_2 , $(CF_2)_rCF_3$, $(CH_2)_rOC_{1-5}$ alkyl, $(CH_2)_rOH$, $(CH_2)_rSC_{1-5}$ alkyl, and $(CH_2)_rNR^{6d}R^{6d}$;
- R^{6d} , at each occurrence, is selected from H, C_{1-6} alkyl, and C_{3-6} cycloalkyl;
- 10 R^7 , is selected from H, C_{1-6} alkyl, C_{2-8} alkenyl, C_{2-8} alkynyl, $(CH_2)_qOH$, $(CH_2)_qSH$, $(CH_2)_qOR^{7d}$, $(CH_2)_qSR^{7d}$, $(CH_2)_qNR^{7a}R^{7a'}$, $(CH_2)_rC(O)OH$, $(CH_2)_rC(O)R^{7b}$, $(CH_2)_rC(O)NR^{7a}R^{7a'}$, $(CH_2)_qNR^{7a}C(O)R^{7a}$, $(CH_2)_qNR^{7a}C(O)H$, $(CH_2)_rC(O)OR^{7b}$, $(CH_2)_qOC(O)R^{7b}$, $(CH_2)_qS(O)_pR^{7b}$, $(CH_2)_qS(O)_2NR^{7a}R^{7a'}$, $(CH_2)_qNR^{7a}S(O)_2R^{7b}$, C_{1-6} haloalkyl,
- 15 a $(CH_2)_r-C_{3-10}$ carbocyclic residue substituted with 0-3 R^{7c} , and a $(CH_2)_r-5-10$ membered heterocyclic system containing 1-4 heteroatoms selected from N, O, and S, substituted with 0-2 R^{7c} ;
- 20 R^{7a} and $R^{7a'}$, at each occurrence, are selected from H, C_{1-6} alkyl, C_{2-8} alkenyl, C_{2-8} alkynyl, $(CH_2)_rC_{3-6}$ cycloalkyl, a $(CH_2)_r-C_{3-10}$ carbocyclic residue substituted with 0-5 R^{7e} , and a $(CH_2)_r-5-10$ membered heterocyclic system containing 1-4 heteroatoms
- 25 selected from N, O, and S, substituted with 0-3 R^{7e} ;
- R^{7b} , at each occurrence, is selected from C_{1-6} alkyl, C_{2-8} alkenyl, C_{2-8} alkynyl, a $(CH_2)_r-C_{3-6}$ carbocyclic residue substituted with 0-2 R^{7e} , and a $(CH_2)_r-5-6$ membered
- 30 heterocyclic system containing 1-4 heteroatoms selected from N, O, and S, substituted with 0-3 R^{7e} ;
- R^{7c} , at each occurrence, is selected from C_{1-6} alkyl, C_{2-8} alkenyl, C_{2-8} alkynyl, $(CH_2)_rC_{3-6}$ cycloalkyl, Cl, Br, I,
- 35 F, $(CF_2)_rCF_3$, NO_2 , CN, $(CH_2)_rNR^{7f}R^{7f}$, $(CH_2)_rOH$, $(CH_2)_rOC_{1-4}$ alkyl, $(CH_2)_rSC_{1-4}$ alkyl, $(CH_2)_rC(O)OH$, $(CH_2)_rC(O)R^{7b}$, $(CH_2)_rC(O)NR^{7f}R^{7f}$, $(CH_2)_rNR^{7f}C(O)R^{7a}$,

$(\text{CH}_2)_r\text{C}(\text{O})\text{OC}_{1-4}$ alkyl, $(\text{CH}_2)_r\text{OC}(\text{O})\text{R}^{7b}$,
 $(\text{CH}_2)_r\text{C}(=\text{NR}^{7f})\text{NR}^{7f}\text{R}^{7f}$, $(\text{CH}_2)_r\text{S}(\text{O})_p\text{R}^{7b}$,
 $(\text{CH}_2)_r\text{NHC}(=\text{NR}^{7f})\text{NR}^{7f}\text{R}^{7f}$, $(\text{CH}_2)_r\text{S}(\text{O})_2\text{NR}^{7f}\text{R}^{7f}$,
 $(\text{CH}_2)_r\text{NR}^{7f}\text{S}(\text{O})_2\text{R}^{7b}$, and $(\text{CH}_2)_r$ phenyl substituted with 0-
 5 3 R^{7e} ;

R^{7d} , at each occurrence, is selected from C_{1-6} alkyl
 substituted with 0-3 R^{7e} , alkenyl, alkynyl, and a C_{3-10}
 10 carbocyclic residue substituted with 0-3 R^{7c} ;

R^{7e} , at each occurrence, is selected from C_{1-6} alkyl, C_{2-8}
 alkenyl, C_{2-8} alkynyl, C_{3-6} cycloalkyl, Cl, F, Br, I,
 CN, NO_2 , $(\text{CF}_2)_r\text{CF}_3$, $(\text{CH}_2)_r\text{OC}_{1-5}$ alkyl, OH, SH, $(\text{CH}_2)_r\text{SC}_{1-}$
 15 5 alkyl, $(\text{CH}_2)_r\text{NR}^{7f}\text{R}^{7f}$, and $(\text{CH}_2)_r$ phenyl;

R^{7f} , at each occurrence, is selected from H, C_{1-6} alkyl, and
 C_{3-6} cycloalkyl;

R^8 is selected from H, C_{1-6} alkyl, C_{3-6} cycloalkyl, and
 20 $(\text{CH}_2)_t$ phenyl substituted with 0-3 R^{8a} ;

R^{8a} , at each occurrence, is selected from C_{1-6} alkyl, C_{2-8}
 alkenyl, C_{2-8} alkynyl, C_{3-6} cycloalkyl, Cl, F, Br, I,
 CN, NO_2 , $(\text{CF}_2)_r\text{CF}_3$, $(\text{CH}_2)_r\text{OC}_{1-5}$ alkyl, OH, SH, $(\text{CH}_2)_r\text{SC}_{1-}$
 25 5 alkyl, $(\text{CH}_2)_r\text{NR}^{7f}\text{R}^{7f}$, and $(\text{CH}_2)_r$ phenyl;

alternatively, R^7 and R^8 join to form C_{3-7} cycloalkyl, or
 $=\text{NR}^{8b}$;

R^{8b} is selected from H, C_{1-6} alkyl, C_{3-6} cycloalkyl, OH, CN,
 30 and $(\text{CH}_2)_r$ -phenyl;

R^9 , is selected from H, C_{1-6} alkyl, C_{2-8} alkenyl, C_{2-8}
 alkynyl, F, Cl, Br, I, NO_2 , CN, $(\text{CH}_2)_r\text{OH}$, $(\text{CH}_2)_r\text{SH}$,
 35 $(\text{CH}_2)_r\text{OR}^{9d}$, $(\text{CH}_2)_r\text{SR}^{9d}$, $(\text{CH}_2)_r\text{NR}^{9a}\text{R}^{9a'}$, $(\text{CH}_2)_r\text{C}(\text{O})\text{OH}$,
 $(\text{CH}_2)_r\text{C}(\text{O})\text{R}^{9b}$, $(\text{CH}_2)_r\text{C}(\text{O})\text{NR}^{9a}\text{R}^{9a'}$, $(\text{CH}_2)_r\text{NR}^{9a}\text{C}(\text{O})\text{R}^{9a}$,
 $(\text{CH}_2)_r\text{NR}^{9a}\text{C}(\text{O})\text{H}$, $(\text{CH}_2)_r\text{NR}^{9a}\text{C}(\text{O})\text{NHR}^{9a}$, $(\text{CH}_2)_r\text{C}(\text{O})\text{OR}^{9b}$,

(CH₂)_rOC(O)R^{9b}, (CH₂)_rOC(O)NHR^{9a}, (CH₂)_rS(O)_pR^{9b},
 (CH₂)_rS(O)₂NR^{9a}R^{9a'}, (CH₂)_rNR^{9a}S(O)₂R^{9b}, C₁₋₆ haloalkyl,
 a (CH₂)_r-C₃₋₁₀ carbocyclic residue substituted with 0-5
 R^{9c}, and a (CH₂)_r-5-10 membered heterocyclic system
 5 containing 1-4 heteroatoms selected from N, O, and S,
 substituted with 0-3 R^{9c};

R^{9a} and R^{9a'}, at each occurrence, are selected from H, C₁₋₆
 alkyl, C₂₋₈ alkenyl, C₂₋₈ alkynyl, a (CH₂)_r-C₃₋₁₀
 10 carbocyclic residue substituted with 0-5 R^{9e}, and a
 (CH₂)_r-5-10 membered heterocyclic system containing 1-4
 heteroatoms selected from N, O, and S, substituted
 with 0-3 R^{9e};

15 R^{9b}, at each occurrence, is selected from C₁₋₆ alkyl, C₂₋₈
 alkenyl, C₂₋₈ alkynyl, a (CH₂)_r-C₃₋₆ carbocyclic residue
 substituted with 0-2 R^{9e}, and a (CH₂)_r-5-6 membered
 heterocyclic system containing 1-4 heteroatoms
 selected from N, O, and S, substituted with 0-3 R^{9e};

20 R^{9c}, at each occurrence, is selected from C₁₋₆ alkyl, C₂₋₈
 alkenyl, C₂₋₈ alkynyl, (CH₂)_rC₃₋₆ cycloalkyl, Cl, Br, I,
 F, (CF₂)_rCF₃, NO₂, CN, (CH₂)_rNR^{9f}R^{9f}, (CH₂)_rOH,
 (CH₂)_rOC₁₋₄ alkyl, (CH₂)_rSC₁₋₄ alkyl, (CH₂)_rC(O)OH,
 25 (CH₂)_rC(O)R^{9b}, (CH₂)_rC(O)NR^{9f}R^{9f}, (CH₂)_rNR^{9f}C(O)R^{9a},
 (CH₂)_rC(O)OC₁₋₄ alkyl, (CH₂)_rOC(O)R^{9b},
 (CH₂)_rC(=NR^{9f})NR^{9f}R^{9f}, (CH₂)_rS(O)_pR^{9b},
 (CH₂)_rNHC(=NR^{9f})NR^{9f}R^{9f}, (CH₂)_rS(O)₂NR^{9f}R^{9f},
 (CH₂)_rNR^{9f}S(O)₂R^{9b}, and (CH₂)_rphenyl substituted with 0-
 30 3 R^{9e};

R^{9d}, at each occurrence, is selected from C₁₋₆ alkyl, C₂₋₆
 alkenyl, C₂₋₆ alkynyl, a C₃₋₁₀ carbocyclic residue
 substituted with 0-3 R^{9c}, and a 5-6 membered
 35 heterocyclic system containing 1-4 heteroatoms
 selected from the group consisting of N, O, and S
 substituted with 0-3 R^{9c};

- 5 R^{9e} , at each occurrence, is selected from C_{1-6} alkyl, C_{2-8} alkenyl, C_{2-8} alkynyl, $(CH_2)_r C_{3-6}$ cycloalkyl, Cl, F, Br, I, CN, NO_2 , $(CF_2)_r CF_3$, $(CH_2)_r OC_{1-5}$ alkyl, OH, SH, $(CH_2)_r SC_{1-5}$ alkyl, $(CH_2)_r NR^{9f} R^{9f}$, and $(CH_2)_r$ phenyl;
- R^{9f} , at each occurrence, is selected from H, C_{1-6} alkyl, and C_{3-6} cycloalkyl;
- 10 R^{10} , is selected from H, C_{1-6} alkyl, C_{2-8} alkenyl, C_{2-8} alkynyl, F, Cl, Br, I, NO_2 , CN, $(CH_2)_r OH$, $(CH_2)_r OR^{10d}$, $(CH_2)_r SR^{10d}$, $(CH_2)_r NR^{10a} R^{10a'}$, $(CH_2)_r C(O)OH$, $(CH_2)_r C(O)R^{10b}$, $(CH_2)_r C(O)NR^{10a} R^{10a'}$, $(CH_2)_r NR^{10a} C(O)R^{10a}$, $(CH_2)_r NR^{10a} C(O)H$, $(CH_2)_r C(O)OR^{10b}$, $(CH_2)_r OC(O)R^{10b}$, $(CH_2)_r S(O)_p R^{10b}$, $(CH_2)_r S(O)_2 NR^{10a} R^{10a'}$, $(CH_2)_r NR^{10a} S(O)_2 R^{10b}$, C_{1-6} haloalkyl, a $(CH_2)_r C_{3-10}$ carbocyclic residue substituted with 0-5 R^{10c} , and a $(CH_2)_r C_{5-10}$ membered heterocyclic system containing 1-4 heteroatoms selected from N, O, and S, substituted with 0-3 R^{10c} ;
- 15 R^{10a} and $R^{10a'}$, at each occurrence, are selected from H, C_{1-6} alkyl, C_{2-8} alkenyl, C_{2-8} alkynyl, a $(CH_2)_r C_{3-10}$ carbocyclic residue substituted with 0-5 R^{10e} , and a $(CH_2)_r C_{5-10}$ membered heterocyclic system containing 1-4 heteroatoms selected from N, O, and S, substituted with 0-3 R^{10e} ;
- 20 R^{10b} , at each occurrence, is selected from C_{1-6} alkyl, C_{2-8} alkenyl, C_{2-8} alkynyl, a $(CH_2)_r C_{3-6}$ carbocyclic residue substituted with 0-2 R^{10e} , and a $(CH_2)_r C_{5-6}$ membered heterocyclic system containing 1-4 heteroatoms selected from N, O, and S, substituted with 0-3 R^{10e} ;
- 25 R^{10c} , at each occurrence, is selected from C_{1-6} alkyl, C_{2-8} alkenyl, C_{2-8} alkynyl, $(CH_2)_r C_{3-6}$ cycloalkyl, Cl, Br, I, F, $(CF_2)_r CF_3$, NO_2 , CN, $(CH_2)_r NR^{10f} R^{10f}$, $(CH_2)_r OH$,
- 30 R^{10d} , at each occurrence, is selected from H, C_{1-6} alkyl, C_{2-8} alkenyl, C_{2-8} alkynyl, $(CH_2)_r C_{3-6}$ cycloalkyl, Cl, Br, I, F, $(CF_2)_r CF_3$, NO_2 , CN, $(CH_2)_r NR^{10f} R^{10f}$, $(CH_2)_r OH$,
- 35 R^{10e} , at each occurrence, is selected from C_{1-6} alkyl, C_{2-8} alkenyl, C_{2-8} alkynyl, $(CH_2)_r C_{3-6}$ cycloalkyl, Cl, Br, I, F, $(CF_2)_r CF_3$, NO_2 , CN, $(CH_2)_r NR^{10f} R^{10f}$, $(CH_2)_r OH$,

$(\text{CH}_2)_r\text{OC}_{1-4}$ alkyl, $(\text{CH}_2)_r\text{SC}_{1-4}$ alkyl, $(\text{CH}_2)_r\text{C}(\text{O})\text{OH}$,
 $(\text{CH}_2)_r\text{C}(\text{O})\text{R}^{10b}$, $(\text{CH}_2)_r\text{C}(\text{O})\text{NR}^{10f}\text{R}^{10f}$, $(\text{CH}_2)_r\text{NR}^{10f}\text{C}(\text{O})\text{R}^{10a}$,
 $(\text{CH}_2)_r\text{C}(\text{O})\text{OC}_{1-4}$ alkyl, $(\text{CH}_2)_r\text{OC}(\text{O})\text{R}^{10b}$,
 $(\text{CH}_2)_r\text{C}(=\text{NR}^{10f})\text{NR}^{10f}\text{R}^{10f}$, $(\text{CH}_2)_r\text{S}(\text{O})_p\text{R}^{10b}$,
5 $(\text{CH}_2)_r\text{NHC}(=\text{NR}^{10f})\text{NR}^{10f}\text{R}^{10f}$, $(\text{CH}_2)_r\text{S}(\text{O})_2\text{NR}^{10f}\text{R}^{10f}$,
 $(\text{CH}_2)_r\text{NR}^{10f}\text{S}(\text{O})_2\text{R}^{10b}$, and $(\text{CH}_2)_r$ phenyl substituted with
0-3 R^{10e} ;

10 R^{10d} , at each occurrence, is selected from C_{1-6} alkyl, C_{2-6}
alkenyl, C_{2-6} alkynyl, a C_{3-10} carbocyclic residue
substituted with 0-3 R^{10c} , and a 5-6 membered
heterocyclic system containing 1-4 heteroatoms
selected from the group consisting of N, O, and S
substituted with 0-3 R^{10c} ;

15 R^{10e} , at each occurrence, is selected from C_{1-6} alkyl, C_{2-8}
alkenyl, C_{2-8} alkynyl, $(\text{CH}_2)_r\text{C}_{3-6}$ cycloalkyl, Cl, F, Br,
I, CN, NO_2 , $(\text{CF}_2)_r\text{CF}_3$, $(\text{CH}_2)_r\text{OC}_{1-5}$ alkyl, OH, SH,
 $(\text{CH}_2)_r\text{SC}_{1-5}$ alkyl, $(\text{CH}_2)_r\text{NR}^{10f}\text{R}^{10f}$, and $(\text{CH}_2)_r$ phenyl;

20 R^{10f} , at each occurrence, is selected from H, C_{1-5} alkyl,
and C_{3-6} cycloalkyl;

25 alternatively, R^9 and R^{10} join to form C_{3-7} cycloalkyl, 5-6-
membered cyclic ketal or =O;

with the proviso that when R^{10} is -OH, R^9 is not halogen,
cyano, or bonded to the carbon to which it is attached
through a heteroatom;

30 R^{11} , is selected from H, C_{1-6} alkyl, C_{2-8} alkenyl, C_{2-8}
alkynyl, $(\text{CH}_2)_q\text{OH}$, $(\text{CH}_2)_q\text{SH}$, $(\text{CH}_2)_q\text{OR}^{11d}$, $(\text{CH}_2)_q\text{SR}^{11d}$,
 $(\text{CH}_2)_q\text{NR}^{11a}\text{R}^{11a'}$, $(\text{CH}_2)_r\text{C}(\text{O})\text{OH}$, $(\text{CH}_2)_r\text{C}(\text{O})\text{R}^{11b}$,
 $(\text{CH}_2)_r\text{C}(\text{O})\text{NR}^{11a}\text{R}^{11a'}$, $(\text{CH}_2)_q\text{NR}^{11a}\text{C}(\text{O})\text{R}^{11a}$,
35 $(\text{CH}_2)_q\text{NR}^{11a}\text{C}(\text{O})\text{NHR}^{11a}$, $(\text{CH}_2)_r\text{C}(\text{O})\text{OR}^{11b}$, $(\text{CH}_2)_q\text{OC}(\text{O})\text{R}^{11b}$,
 $(\text{CH}_2)_q\text{S}(\text{O})_p\text{R}^{11b}$, $(\text{CH}_2)_q\text{S}(\text{O})_2\text{NR}^{11a}\text{R}^{11a'}$,
 $(\text{CH}_2)_q\text{NR}^{11a}\text{S}(\text{O})_2\text{R}^{11b}$, C_{1-6} haloalkyl, a $(\text{CH}_2)_r\text{-C}_{3-10}$

carbocyclic residue substituted with 0-5 R^{11c}, and a (CH₂)_r-5-10 membered heterocyclic system containing 1-4 heteroatoms selected from N, O, and S, substituted with 0-3 R^{11c};

5

R^{11a} and R^{11a'}, at each occurrence, are selected from H, C₁₋₆ alkyl, C₂₋₈ alkenyl, C₂₋₈ alkynyl, a (CH₂)_r-C₃₋₁₀ carbocyclic residue substituted with 0-5 R^{11e}, and a (CH₂)_r-5-10 membered heterocyclic system containing 1-4 heteroatoms selected from N, O, and S, substituted with 0-3 R^{11e};

10

R^{11b}, at each occurrence, is selected from C₁₋₆ alkyl, C₂₋₈ alkenyl, C₂₋₈ alkynyl, a (CH₂)_r-C₃₋₆ carbocyclic residue substituted with 0-2 R^{11e}, and a (CH₂)_r-5-6 membered heterocyclic system containing 1-4 heteroatoms selected from N, O, and S, substituted with 0-3 R^{11e};

15

R^{11c}, at each occurrence, is selected from C₁₋₆ alkyl, C₂₋₈ alkenyl, C₂₋₈ alkynyl, (CH₂)_r-C₃₋₆ cycloalkyl, Cl, Br, I, F, (CF₂)_r-CF₃, NO₂, CN, (CH₂)_r-NR^{11f}R^{11f}, (CH₂)_r-OH, (CH₂)_r-OC₁₋₄ alkyl, (CH₂)_r-SC₁₋₄ alkyl, (CH₂)_r-C(O)OH, (CH₂)_r-C(O)R^{11b}, (CH₂)_r-C(O)NR^{11f}R^{11f}, (CH₂)_r-NR^{11f}C(O)R^{11a}, (CH₂)_r-C(O)OC₁₋₄ alkyl, (CH₂)_r-OC(O)R^{11b}, (CH₂)_r-C(=NR^{11f})NR^{11f}R^{11f}, (CH₂)_r-NHC(=NR^{11f})NR^{11f}R^{11f}, (CH₂)_r-S(O)_pR^{11b}, (CH₂)_r-S(O)₂NR^{11f}R^{11f}, (CH₂)_r-NR^{11f}S(O)₂R^{11b}, and (CH₂)_r-phenyl substituted with 0-3 R^{11e};

20

25

R^{11d}, at each occurrence, is selected from C₁₋₆ alkyl substituted with 0-3 R^{11e}, C₂₋₆ alkenyl, C₂₋₆ alkynyl, and a C₃₋₁₀ carbocyclic residue substituted with 0-3 R^{11c};

30

R^{11e}, at each occurrence, is selected from C₁₋₆ alkyl, C₂₋₈ alkenyl, C₂₋₈ alkynyl, C₃₋₆ cycloalkyl, Cl, F, Br, I,

35

CN, NO₂, (CF₂)_rCF₃, (CH₂)_rOC₁₋₅ alkyl, OH, SH, (CH₂)_rSC₁₋₅ alkyl, (CH₂)_rNR^{11f}R^{11f}, and (CH₂)_rphenyl;

5 R^{11f}, at each occurrence, is selected from H, C₁₋₆ alkyl, and C₃₋₆ cycloalkyl;

R¹² is selected from H, C₁₋₆ alkyl, (CH₂)_qOH, (CH₂)_rC₃₋₆ cycloalkyl, and (CH₂)_tphenyl substituted with 0-3 R^{12a};

10 R^{12a}, at each occurrence, is selected from C₁₋₆ alkyl, C₂₋₈ alkenyl, C₂₋₈ alkynyl, C₃₋₆ cycloalkyl, Cl, F, Br, I, CN, NO₂, (CF₂)_rCF₃, (CH₂)_rOC₁₋₅ alkyl, OH, SH, (CH₂)_rSC₁₋₅ alkyl, (CH₂)_rNR^{9f}R^{9f}, and (CH₂)_rphenyl;

15 alternatively, R¹¹ and R¹² join to form C₃₋₇ cycloalkyl;

20 R¹³, at each occurrence, is selected from C₁₋₆ alkyl, C₂₋₈ alkenyl, C₂₋₈ alkynyl, C₃₋₆ cycloalkyl, (CF₂)_wCF₃, (CH₂)NR^{13a}R^{13a'}, (CH₂)OH, (CH₂)OR^{13b}, (CH₂)SH, (CH₂)SR^{13b}, (CH₂)_wC(O)OH, (CH₂)_wC(O)R^{13b}, (CH₂)_wC(O)NR^{13a}R^{13a'}, (CH₂)NR^{13d}C(O)R^{13a}, (CH₂)_wC(O)OR^{13b}, (CH₂)OC(O)R^{13b}, (CH₂)_wS(O)_pR^{13b}, (CH₂)_wS(O)₂NR^{13a}R^{13a'}, (CH₂)NR^{13d}S(O)₂R^{13b}, and (CH₂)_w-phenyl substituted with 0-3 R^{13c};

25 R^{13a} and R^{13a'}, at each occurrence, are selected from H, C₁₋₆ alkyl, C₃₋₆ cycloalkyl, and phenyl substituted with 0-3 R^{13c};

30 R^{13b}, at each occurrence, is selected from C₁₋₆ alkyl, C₃₋₆ cycloalkyl, and phenyl substituted with 0-3 R^{13c};

35 R^{13c}, at each occurrence, is selected from C₁₋₆ alkyl, C₃₋₆ cycloalkyl, Cl, F, Br, I, CN, NO₂, (CF₂)_rCF₃, (CH₂)_rOC₁₋₅ alkyl, (CH₂)_rOH, (CH₂)_rSC₁₋₅ alkyl, and (CH₂)_rNR^{13d}R^{13d};

- R^{13d}, at each occurrence, is selected from H, C₁₋₆ alkyl, and C₃₋₆ cycloalkyl;
- 5 R¹⁴, at each occurrence, is selected from C₁₋₆ alkyl, C₂₋₈ alkenyl, C₂₋₈ alkynyl, (CH₂)_rC₃₋₆ cycloalkyl, Cl, Br, I, F, NO₂, CN, (CHR')_rNR^{14a}R^{14a'}, (CHR')_rOH, (CHR')_rO(CHR')_rR^{14d}, (CHR')_rSH, (CHR')_rC(O)H, (CHR')_rS(CHR')_rR^{14d}, (CHR')_rC(O)OH, (CHR')_rC(O)(CHR')_rR^{14b}, (CHR')_rC(O)NR^{14a}R^{14a'}, (CHR')_rNR^{14f}C(O)(CHR')_rR^{14b}, (CHR')_rC(O)O(CHR')_rR^{14d}, (CHR')_rOC(O)(CHR')_rR^{14b}, (CHR')_rC(=NR^{14f})NR^{14a}R^{14a'}, (CHR')_rNHC(=NR^{14f})NR^{14f}R^{14f}, (CHR')_rS(O)_p(CHR')_rR^{14b}, (CHR')_rS(O)₂NR^{14a}R^{14a'}, (CHR')_rNR^{14f}S(O)₂(CHR')_rR^{14b}, C₁₋₆ haloalkyl, C₂₋₈ alkenyl substituted with 0-3 R', C₂₋₈ alkynyl substituted with 0-3 R', (CHR')_rphenyl substituted with 0-3 R^{14e}, and a (CH₂)_{r-5-10} membered heterocyclic system containing 1-4 heteroatoms selected from N, O, and S, substituted with 0-2 R^{15e};
- 10
- 15
- 20 R', at each occurrence, is selected from H, C₁₋₆ alkyl, C₂₋₈ alkenyl, C₂₋₈ alkynyl, (CH₂)_rC₃₋₆ cycloalkyl, and (CH₂)_rphenyl substituted with R^{14e};
- 25 R^{14a} and R^{14a'}, at each occurrence, are selected from H, C₁₋₆ alkyl, C₂₋₈ alkenyl, C₂₋₈ alkynyl, a (CH₂)_{r-C3-10} carbocyclic residue substituted with 0-5 R^{14e}, and a (CH₂)_{r-5-10} membered heterocyclic system containing 1-4 heteroatoms selected from N, O, and S, substituted with 0-2 R^{14e};
- 30 R^{14b}, at each occurrence, is selected from C₁₋₆ alkyl, C₂₋₈ alkenyl, C₂₋₈ alkynyl, a (CH₂)_{r-C3-6} carbocyclic residue substituted with 0-3 R^{14e}, and (CH₂)_{r-5-6} membered heterocyclic system containing 1-4 heteroatoms selected from N, O, and S, substituted with 0-2 R^{14e};
- 35

R^{14d}, at each occurrence, is selected from C₂₋₈ alkenyl, C₂₋₈ alkyne, C₁₋₆ alkyl substituted with 0-3 R^{14e}, a (CH₂)_r-C₃₋₁₀ carbocyclic residue substituted with 0-3 R^{14e}, and a (CH₂)_r-5-6 membered heterocyclic system containing 1-4 heteroatoms selected from N, O, and S, substituted with 0-3 R^{14e};

R^{14e}, at each occurrence, is selected from C₁₋₆ alkyl, C₂₋₈ alkenyl, C₂₋₈ alkyne, (CH₂)_r-C₃₋₆ cycloalkyl, Cl, F, Br, I, CN, NO₂, (CF₂)_rCF₃, (CH₂)_rOC₁₋₅ alkyl, OH, SH, (CH₂)_rSC₁₋₅ alkyl, (CH₂)_rNR^{14f}R^{14f}, and (CH₂)_rphenyl;

R^{14f}, at each occurrence, is selected from H, C₁₋₆ alkyl, C₃₋₆ cycloalkyl, and phenyl;

alternatively, R¹⁴ joins with R⁴ to form a 5, 6 or 7 membered piperidinium spirocycle or pyrrolidinium spirocycle fused to ring A, the spirocycle substituted with 0-3 R^a;

R¹⁵, at each occurrence, is selected from C₁₋₆ alkyl, C₂₋₈ alkenyl, C₂₋₈ alkyne, (CH₂)_r-C₃₋₆ cycloalkyl, Cl, Br, I, F, NO₂, CN, (CHR')_rNR^{15a}R^{15a'}, (CHR')_rOH, (CHR')_rO(CHR')_rR^{15d}, (CHR')_rSH, (CHR')_rC(O)H, (CHR')_rS(CHR')_rR^{15d}, (CHR')_rC(O)OH, (CHR')_rC(O)(CHR')_rR^{15b}, (CHR')_rC(O)NR^{15a}R^{15a'}, (CHR')_rNR^{15f}C(O)(CHR')_rR^{15b}, (CHR')_rC(O)O(CHR')_rR^{15d}, (CHR')_rOC(O)(CHR')_rR^{15b}, (CHR')_rC(O)NR^{15a}R^{15a'}, (CHR')_rC(=NR^{15f})NR^{15a}R^{15a'}, (CHR')_rNHC(=NR^{15f})NR^{15f}R^{15f}, (CHR')_rS(O)_p(CHR')_rR^{15b}, (CHR')_rS(O)₂NR^{15a}R^{15a'}, (CHR')_rNR^{15f}S(O)₂(CHR')_rR^{15b}, C₁₋₆ haloalkyl, C₂₋₈ alkenyl substituted with 0-3 R', C₂₋₈ alkyne substituted with 0-3 R', (CHR')_rphenyl substituted with 0-3 R^{15e}, and a (CH₂)_r-5-10 membered heterocyclic system containing 1-4 heteroatoms selected from N, O, and S, substituted with 0-2 R^{15e};

- 5 R^{15a} and $R^{15a'}$, at each occurrence, are selected from H, C_{1-6} alkyl, C_{2-8} alkenyl, C_{2-8} alkynyl, a $(CH_2)_r-C_{3-10}$ carbocyclic residue substituted with 0-5 R^{15e} , and a $(CH_2)_r-5-10$ membered heterocyclic system containing 1-4 heteroatoms selected from N, O, and S, substituted with 0-2 R^{15e} ;
- 10 R^{15b} , at each occurrence, is selected from C_{1-6} alkyl, C_{2-8} alkenyl, C_{2-8} alkynyl, a $(CH_2)_r-C_{3-6}$ carbocyclic residue substituted with 0-3 R^{15e} , and $(CH_2)_r-5-6$ membered heterocyclic system containing 1-4 heteroatoms selected from N, O, and S, substituted with 0-2 R^{15e} ;
- 15 R^{15d} , at each occurrence, is selected from C_{2-8} alkenyl, C_{2-8} alkynyl, C_{1-6} alkyl substituted with 0-3 R^{15e} , a $(CH_2)_r-C_{3-10}$ carbocyclic residue substituted with 0-3 R^{15e} , and a $(CH_2)_r-5-6$ membered heterocyclic system containing 1-4 heteroatoms selected from N, O, and S, substituted with 0-3 R^{15e} ;
- 20 R^{15e} , at each occurrence, is selected from C_{1-6} alkyl, C_{2-8} alkenyl, C_{2-8} alkynyl, $(CH_2)_r-C_{3-6}$ cycloalkyl, Cl, F, Br, I, CN, NO_2 , $(CF_2)_rCF_3$, $(CH_2)_rOC_{1-5}$ alkyl, OH, SH, $(CH_2)_rSC_{1-5}$ alkyl, $(CH_2)_rNR^{15f}R^{15f}$, and $(CH_2)_r$ phenyl;
- 25 R^{15f} , at each occurrence, is selected from H, C_{1-6} alkyl, C_{3-6} cycloalkyl, and phenyl;
- 30 R^{16} , at each occurrence, is selected from C_{1-6} alkyl, C_{2-8} alkenyl, C_{2-8} alkynyl, $(CH_2)_r-C_{3-6}$ cycloalkyl, Cl, Br, I, F, NO_2 , CN, $(CHR')_rNR^{16a}R^{16a'}$, $(CHR')_rOH$, $(CHR')_rO(CHR')_rR^{16d}$, $(CHR')_rSH$, $(CHR')_rC(O)H$, $(CHR')_rS(CHR')_rR^{16d}$, $(CHR')_rC(O)OH$, $(CHR')_rC(O)(CHR')_rR^{16b}$, $(CHR')_rC(O)NR^{16a}R^{16a'}$, $(CHR')_rNR^{16f}C(O)(CHR')_rR^{16b}$, $(CHR')_rC(O)O(CHR')_rR^{16d}$, $(CHR')_rOC(O)(CHR')_rR^{16b}$, $(CHR')_rC(=NR^{16f})NR^{16a}R^{16a'}$, $(CHR')_rNHC(=NR^{16f})NR^{16f}R^{16f}$, $(CHR')_rS(O)_p(CHR')_rR^{16b}$,

$(CHR')_rS(O)_2NR^{16a}R^{16a'}$, $(CHR')_rNR^{16f}S(O)_2(CHR')_rR^{16b}$, C₁₋₆ haloalkyl, C₂₋₈ alkenyl substituted with 0-3 R', C₂₋₈ alkynyl substituted with 0-3 R', and $(CHR')_r$ phenyl substituted with 0-3 R^{16e};

5

R^{16a} and R^{16a'}, at each occurrence, are selected from H, C₁₋₆ alkyl, C₂₋₈ alkenyl, C₂₋₈ alkynyl, a $(CH_2)_r$ -C₃₋₁₀ carbocyclic residue substituted with 0-5 R^{16e}, and a $(CH_2)_r$ -5-10 membered heterocyclic system containing 1-4 heteroatoms selected from N, O, and S, substituted with 0-2 R^{16e};

10

R^{16b}, at each occurrence, is selected from C₁₋₆ alkyl, C₂₋₈ alkenyl, C₂₋₈ alkynyl, a $(CH_2)_r$ -C₃₋₆ carbocyclic residue substituted with 0-3 R^{16e}, and a $(CH_2)_r$ -5-6 membered heterocyclic system containing 1-4 heteroatoms selected from N, O, and S, substituted with 0-2 R^{16e};

15

R^{16d}, at each occurrence, is selected from C₂₋₈ alkenyl, C₂₋₈ alkynyl, C₁₋₆ alkyl substituted with 0-3 R^{16e}, a $(CH_2)_r$ -C₃₋₁₀ carbocyclic residue substituted with 0-3 R^{16e}, and a $(CH_2)_r$ -5-6 membered heterocyclic system containing 1-4 heteroatoms selected from N, O, and S, substituted with 0-3 R^{16e};

20

25

R^{16e}, at each occurrence, is selected from C₁₋₆ alkyl, C₂₋₈ alkenyl, C₂₋₈ alkynyl, $(CH_2)_r$ -C₃₋₆ cycloalkyl, Cl, F, Br, I, CN, NO₂, $(CF_2)_r$ CF₃, $(CH_2)_r$ OC₁₋₅ alkyl, OH, SH, $(CH_2)_r$ SC₁₋₅ alkyl, $(CH_2)_r$ NR^{16f}R^{16f}, and $(CH_2)_r$ phenyl;

30

R^{16f}, at each occurrence, is selected from H, C₁₋₆ alkyl, and C₃₋₆ cycloalkyl, and phenyl;

g is selected from 0, 1, 2, 3, and 4;

35

v is selected from 0, 1, and 2;

t is selected from 1 and 2;

w is selected from 0 and 1;

5 r is selected from 0, 1, 2, 3, 4, and 5;

q is selected from 1, 2, 3, 4, and 5; and

p is selected from 1, 2, and 3.

10

[30] In a preferred embodiment, the present invention provides novel compounds of formula (I), wherein:

E is selected from:

15

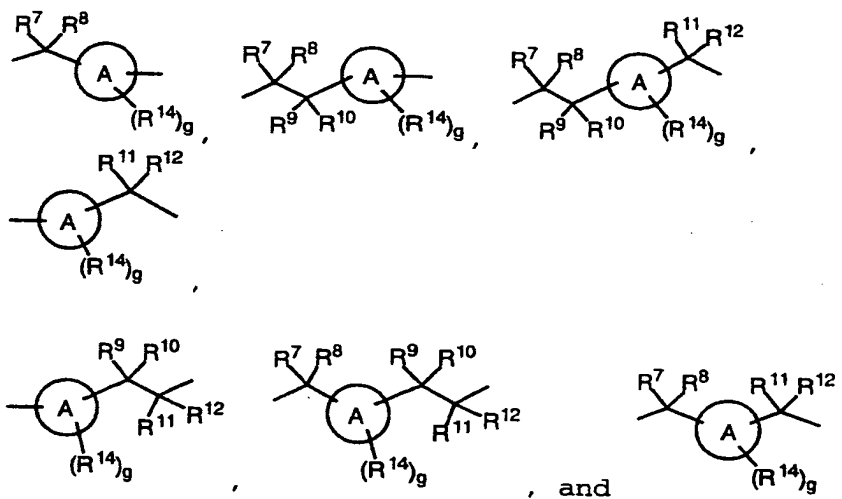

20

R⁴ is absent, taken with the nitrogen to which it is attached to form an N-oxide, or selected from C₁₋₈ alkyl, (CH₂)_rC₃₋₆ cycloalkyl, and (CH₂)_r-phenyl substituted with 0-3 R^{4c};

25

R^{4c}, at each occurrence, is selected from C₁₋₆ alkyl, C₂₋₈ alkenyl, C₂₋₈ alkynyl, C₃₋₆ cycloalkyl, Cl, F, Br, I, CN, NO₂, (CF₂)_rCF₃, (CH₂)_rOC₁₋₅ alkyl, (CH₂)_rOH, (CH₂)_rSC₁₋₅ alkyl, (CH₂)_rNR^{4a}R^{4a'}, and (CH₂)_rphenyl;

alternatively, R⁴ joins with R⁷ or R⁹ to form a 5, 6 or 7
membered piperidinium spirocycle substituted with 0-3
R^a;

5

R¹ and R² are independently selected from H and C₁₋₄ alkyl;

R⁶, at each occurrence, is selected from C₁₋₄ alkyl, C₂₋₈
alkenyl, C₂₋₈ alkynyl, (CH₂)_rC₃₋₆ cycloalkyl, (CF₂)_rCF₃,
10 CN, (CH₂)_rOH, (CH₂)_rOR^{6b}, (CH₂)_rC(O)R^{6b},
(CH₂)_rC(O)NR^{6a}R^{6a'}, (CH₂)_rNR^{6d}C(O)R^{6a}, and (CH₂)_tphenyl
substituted with 0-3 R^{6c};

R^{6a} and R^{6a'}, at each occurrence, are selected from H, C₁₋₆
15 alkyl, C₃₋₆ cycloalkyl, and phenyl substituted with 0-3
R^{6c};

R^{6b}, at each occurrence, is selected from C₁₋₆ alkyl, C₃₋₆
cycloalkyl, and phenyl substituted with 0-3 R^{6c};

20

R^{6c}, at each occurrence, is selected from C₁₋₆ alkyl, C₃₋₆
cycloalkyl, Cl, F, Br, I, CN, NO₂, (CF₂)_rCF₃, (CH₂)_rOC₁₋
5 alkyl, (CH₂)_rOH, (CH₂)_rSC₁₋₅ alkyl, and (CH₂)_rNR^{6d}R^{6d};

25 R^{6d}, at each occurrence, is selected from H, C₁₋₆ alkyl, and
C₃₋₆ cycloalkyl;

R⁷, is selected from H, C₁₋₃ alkyl, (CH₂)_rC₃₋₆ cycloalkyl,
(CH₂)_qOH, (CH₂)_qOR^{7d}, (CH₂)_qNR^{7a}R^{7a'}, (CH₂)_rC(O)R^{7b},
30 (CH₂)_rC(O)NR^{7a}R^{7a'}, (CH₂)_qNR^{7a}C(O)R^{7a}, C₁₋₆ haloalkyl,
(CH₂)_rphenyl with 0-2 R^{7c};

R^{7a} and R^{7a'}, at each occurrence, are selected from H, C₁₋₆
alkyl, (CH₂)_rC₃₋₆ cycloalkyl, a (CH₂)_rphenyl
35 substituted with 0-3 R^{7e};

- R^{7b}, at each occurrence, is selected from C₁₋₆ alkyl, C₂₋₈ alkenyl, C₂₋₈ alkynyl, (CH₂)_rC₃₋₆ cycloalkyl, (CH₂)_rphenyl substituted with 0-3 R^{7e};
- 5 R^{7c}, at each occurrence, is selected from C₁₋₄ alkyl, C₂₋₈ alkenyl, C₂₋₈ alkynyl, (CH₂)_rC₃₋₆ cycloalkyl, Cl, Br, I, F, (CF₂)_rCF₃, NO₂, CN, (CH₂)_rNR^{7f}R^{7f}, (CH₂)_rOH, (CH₂)_rOC₁₋₄ alkyl, (CH₂)_rC(O)R^{7b}, (CH₂)_rC(O)NR^{7f}R^{7f}, (CH₂)_rNR^{7f}C(O)R^{7a}, (CH₂)_rS(O)_pR^{7b}, (CH₂)_rS(O)₂NR^{7f}R^{7f},
 10 (CH₂)_rNR^{7f}S(O)₂R^{7b}, and (CH₂)_rphenyl substituted with 0-2 R^{7e};
- R^{7d}, at each occurrence, is selected from C₁₋₆ alkyl, (CH₂)_rC₃₋₆ cycloalkyl, (CH₂)_rphenyl substituted with 0-
 15 3 R^{7e};
- R^{7e}, at each occurrence, is selected from C₁₋₆ alkyl, C₂₋₈ alkenyl, C₂₋₈ alkynyl, C₃₋₆ cycloalkyl, Cl, F, Br, I, CN, NO₂, (CF₂)_rCF₃, (CH₂)_rOC₁₋₅ alkyl, OH, SH, (CH₂)_rSC₁₋₅ alkyl, (CH₂)_rNR^{7f}R^{7f}, and (CH₂)_rphenyl;
 20
- R^{7f}, at each occurrence, is selected from H, C₁₋₅ alkyl, and C₃₋₆ cycloalkyl;
- 25 R⁸ is H or joins with R⁷ to form C₃₋₇ cycloalkyl or =NR^{8b};
- R¹¹, is selected from H, C₁₋₆ alkyl, (CH₂)_rC₃₋₆ cycloalkyl, (CH₂)_qOH, (CH₂)_qOR^{11d}, (CH₂)_qNR^{11a}R^{11a'}, (CH₂)_rC(O)R^{11b}, (CH₂)_rC(O)NR^{11a}R^{11a'}, (CH₂)_qNR^{11a}C(O)R^{11a}, C₁₋₆ haloalkyl, (CH₂)_rphenyl with 0-2 R^{11c}, (CH₂)_{r-5-10} membered
 30 heterocyclic system containing 1-4 heteroatoms selected from N, O, and S, substituted with 0-3 R¹⁵;
- R^{11a} and R^{11a'}, at each occurrence, are selected from H, C₁₋₆ alkyl, (CH₂)_rC₃₋₆ cycloalkyl, a (CH₂)_rphenyl substituted with 0-3 R^{11e};
- 35

- R^{11b}, at each occurrence, is selected from C₁₋₆ alkyl, C₂₋₈ alkenyl, C₂₋₈ alkynyl, (CH₂)_rC₃₋₆ cycloalkyl, (CH₂)_rphenyl substituted with 0-3 R^{11e};
- 5 R^{11c}, at each occurrence, is selected from C₁₋₄ alkyl, C₂₋₈ alkenyl, C₂₋₈ alkynyl, (CH₂)_rC₃₋₆ cycloalkyl, Cl, Br, I, F, (CF₂)_rCF₃, NO₂, CN, (CH₂)_rNR^{11f}R^{11f}, (CH₂)_rOH, (CH₂)_rOC₁₋₄ alkyl, (CH₂)_rC(O)R^{11b}, (CH₂)_rC(O)NR^{11f}R^{11f}, (CH₂)_rNR^{11f}C(O)R^{11a}, (CH₂)_rS(O)_pR^{11b}, (CH₂)_rS(O)₂NR^{11f}R^{11f}, (CH₂)_rNR^{11f}S(O)₂R^{11b}, and (CH₂)_rphenyl substituted with 0-2 R^{11e};
- 10 R^{11d}, at each occurrence, is selected from C₁₋₆ alkyl, (CH₂)_rC₃₋₆ cycloalkyl, (CH₂)_rphenyl substituted with 0-3 R^{11e};
- 15 R^{11e}, at each occurrence, is selected from C₁₋₆ alkyl, C₂₋₈ alkenyl, C₂₋₈ alkynyl, C₃₋₆ cycloalkyl, Cl, F, Br, I, CN, NO₂, (CF₂)_rCF₃, (CH₂)_rOC₁₋₅ alkyl, OH, SH, (CH₂)_rSC₁₋₅ alkyl, (CH₂)_rNR^{11f}R^{11f}, and (CH₂)_rphenyl;
- 20 R^{11f}, at each occurrence, is selected from H, C₁₋₅ alkyl and C₃₋₆ cycloalkyl;
- 25 R¹² is H or joins with R¹¹ to form C₃₋₇ cycloalkyl;
- R¹³, at each occurrence, is selected from C₁₋₄ alkyl, C₃₋₆ cycloalkyl, (CH₂)NR^{13a}R^{13a'}, (CH₂)OH, (CH₂)OR^{13b}, (CH₂)_wC(O)R^{13b}, (CH₂)_wC(O)NR^{13a}R^{13a'}, (CH₂)NR^{13d}C(O)R^{13a}, (CH₂)_wS(O)₂NR^{13a}R^{13a'}, (CH₂)NR^{13d}S(O)₂R^{13b}, and (CH₂)_w-phenyl substituted with 0-3 R^{13c};
- 30 R^{13a} and R^{13a'}, at each occurrence, are selected from H, C₁₋₆ alkyl, C₃₋₆ cycloalkyl, and phenyl substituted with 0-3 R^{13c};
- 35 R^{13b}, at each occurrence, is selected from C₁₋₆ alkyl, C₃₋₆

cycloalkyl, and phenyl substituted with 0-3 R^{13c};

R^{13c}, at each occurrence, is selected from C₁₋₆ alkyl, C₃₋₆ cycloalkyl, Cl, F, Br, I, CN, NO₂, (CF₂)_rCF₃, (CH₂)_rOC₁₋₅ alkyl, (CH₂)_rOH, and (CH₂)_rNR^{13d}R^{13d};

R^{13d}, at each occurrence, is selected from H, C₁₋₆ alkyl, and C₃₋₆ cycloalkyl;

v is selected from 1 and 2;

q is selected from 1, 2, and 3; and

r is selected from 0, 1, 2, and 3.

[31] In a more preferred embodiment, the present invention provides novel compounds of formula (I), wherein:

ring A is selected from:

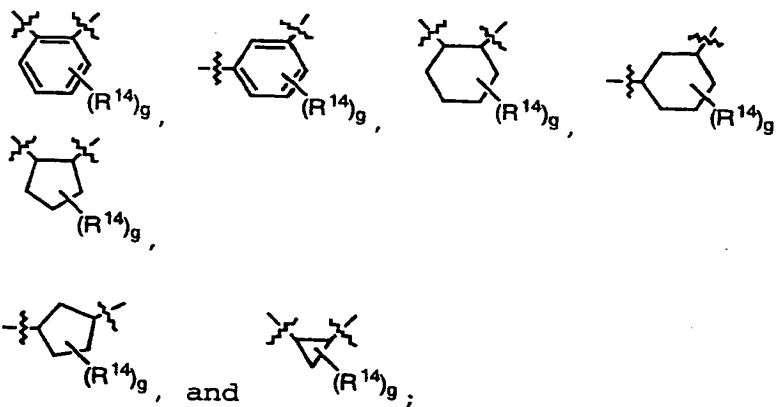

R³ is selected from a (CR^{3'}H)_r-carbocyclic residue substituted with 0-5 R¹⁵, wherein the carbocyclic residue is selected from phenyl, C₃₋₆ cycloalkyl, naphthyl, and adamantyl; and a (CR^{3'}H)_r-heterocyclic system substituted with 0-3 R¹⁵, wherein the heterocyclic system is selected from pyridinyl,

thiophenyl, furanyl, indazolyl, benzothiazolyl,
benzimidazolyl, benzothiophenyl, benzofuranyl,
benzoxazolyl, benzisoxazolyl, quinolinyl,
5 isoquinolinyl, imidazolyl, indolyl, indolinyl,
isoindolyl, isothiadiazolyl, isoxazolyl, piperidinyl,
pyrrazolyl, 1,2,4-triazolyl, 1,2,3-triazolyl,
tetrazolyl, thiadiazolyl, thiazolyl, oxazolyl,
pyrazinyl, and pyrimidinyl; and

10 R⁵ is selected from (CR^{5'}H)_t-phenyl substituted with 0-5
R¹⁶; and a (CR^{5'}H)_t-heterocyclic system substituted
with 0-3 R¹⁶, wherein the heterocyclic system is
selected from pyridinyl, thiophenyl, furanyl,
15 indazolyl, benzothiazolyl, benzimidazolyl,
benzothiophenyl, benzofuranyl, benzoxazolyl,
benzisoxazolyl, quinolinyl, isoquinolinyl, imidazolyl,
indolyl, isoindolyl, piperidinyl, pyrrazolyl, 1,2,4-
triazolyl, 1,2,3-triazolyl, tetrazolyl, thiazolyl,
oxazolyl, pyrazinyl, and pyrimidinyl.

20

[32]. In an even more preferred embodiment, the present
invention provides novel compounds of formula (I-i),
wherein the compound of formula (I-i) is:

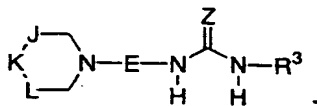

25

(I-i)

R¹⁶, at each occurrence, is selected from C₁₋₈ alkyl,
(CH₂)_rC₃₋₆ cycloalkyl, CF₃, Cl, Br, I, F,
30 (CH₂)_rNR^{16a}R^{16a'}, NO₂, CN, OH, (CH₂)_rOR^{16d},
(CH₂)_rC(O)R^{16b}, (CH₂)_rC(O)NR^{16a}R^{16a'}, (CH₂)_rNR^{16f}C(O)R^{16b},
(CH₂)_rS(O)_pR^{16b}, (CH₂)_rS(O)₂NR^{16a}R^{16a'},
(CH₂)_rNR^{16f}S(O)₂R^{16b}, and (CH₂)_rphenyl substituted with
0-3 R^{16e};

35

R^{16a} and R^{16a'}, at each occurrence, are selected from H, C₁₋₆ alkyl, C₃₋₆ cycloalkyl, and (CH₂)_rphenyl substituted with 0-3 R^{16e};

5 R^{16b}, at each occurrence, is selected from H, C₁₋₆ alkyl, C₃₋₆ cycloalkyl, and (CH₂)_rphenyl substituted with 0-3 R^{16e};

10 R^{16d}, at each occurrence, is selected from C₁₋₆ alkyl and phenyl;

R^{16e}, at each occurrence, is selected from C₁₋₆ alkyl, Cl, F, Br, I, CN, NO₂, (CF₂)_rCF₃, OH, and (CH₂)_rOC₁₋₅ alkyl; and

15 R^{16f}, at each occurrence, is selected from H, and C₁₋₅ alkyl.

20 [33] In an another even more preferred embodiment, the present invention provides novel compounds of formula (I-ii), wherein (I-ii) is:

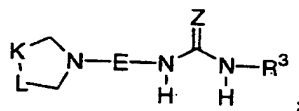

(I-ii)

25 R¹⁶, at each occurrence, is selected from C₁₋₈ alkyl, (CH₂)_rC₃₋₆ cycloalkyl, CF₃, Cl, Br, I, F, (CH₂)_rNR^{16a}R^{16a'}, NO₂, CN, OH, (CH₂)_rOR^{16d}, (CH₂)_rC(O)R^{16b}, (CH₂)_rC(O)NR^{16a}R^{16a'}, (CH₂)_rNR^{16f}C(O)R^{16b},
 30 (CH₂)_rS(O)_pR^{16b}, (CH₂)_rS(O)₂NR^{16a}R^{16a'}, (CH₂)_rNR^{16f}S(O)₂R^{16b}, and (CH₂)_rphenyl substituted with 0-3 R^{16e};

35 R^{16a} and R^{16a'}, at each occurrence, are selected from H, C₁₋₆ alkyl, C₃₋₆ cycloalkyl, and (CH₂)_rphenyl substituted with 0-3 R^{16e};

R^{16b}, at each occurrence, is selected from H, C₁₋₆ alkyl, C₃₋₆ cycloalkyl, and (CH₂)_rphenyl substituted with 0-3 R^{16e};

5

R^{16d}, at each occurrence, is selected from C₁₋₆ alkyl and phenyl;

10 R^{16e}, at each occurrence, is selected from C₁₋₆ alkyl, Cl, F, Br, I, CN, NO₂, (CF₂)_rCF₃, OH, and (CH₂)_rOC₁₋₅ alkyl; and

R^{16f}, at each occurrence, is selected from H, and C₁₋₅ alkyl.

15

[34] In a preferred embodiment, the present invention provides novel compounds of formula (I-i), wherein:

R⁵ is CH₂phenyl substituted with 0-3 R¹⁶;

20

R⁹, is selected from H, C₁₋₆ alkyl, (CH₂)_rC₃₋₆ cycloalkyl, F, Cl, CN, (CH₂)_rOH, (CH₂)_rOR^{9d}, (CH₂)_rNR^{9a}R^{9a'}, (CH₂)_rOC(O)NHR^{9a}, (CH₂)_rphenyl substituted with 0-5 R^{9e}, and a heterocyclic system substituted with 0-2 R^{9e},
25 wherein the heterocyclic system is selected from pyridyl, thiophenyl, furanyl, oxazolyl, and thiazolyl;

R^{9a} and R^{9a'}, at each occurrence, are selected from H, C₁₋₆ alkyl, C₃₋₆ cycloalkyl, and (CH₂)_rphenyl substituted with 0-3 R^{9e};

30

R^{9d}, at each occurrence, is selected from C₁₋₆ alkyl and phenyl;

35 R^{9e}, at each occurrence, is selected from C₁₋₆ alkyl, Cl, F, Br, I, CN, NO₂, (CF₂)_rCF₃, OH, and (CH₂)_rOC₁₋₅ alkyl;

R¹⁰ is selected from H, C₁₋₅ alkyl, OH, and CH₂OH;

alternatively, R⁹ and R¹⁰ join to form C₃₋₇ cycloalkyl, 5-6-membered cyclic ketal or =O;

5

with the proviso that when R¹⁰ is -OH, R⁹ is not halogen, cyano, or bonded to the carbon to which it is attached through a heteroatom;

10 R¹¹ is selected from H, C₁₋₈ alkyl, (CH₂)_rphenyl substituted with 0-5 R^{11e}, and a (CH₂)_r-heterocyclic system substituted with 0-2 R^{11e}, wherein the heterocyclic system is selected from pyridinyl, thiophenyl, furanyl, indazolyl, benzothiazolyl, benzimidazolyl, 15 benzothiophenyl, benzofuranyl, benzoxazolyl, benzisoxazolyl, quinolinyl, isoquinolinyl, imidazolyl, indolyl, isoindolyl, piperidinyl, pyrrolazolyl, 1,2,4-triazolyl, 1,2,3-triazolyl, tetrazolyl, thiazolyl, oxazolyl, pyrazinyl, and pyrimidinyl; and

20

R^{11e}, at each occurrence, is selected from C₁₋₆ alkyl, Cl, F, Br, I, CN, NO₂, (CF₂)_rCF₃, OH, and (CH₂)_rOC₁₋₅ alkyl;

R¹² is H;

25

alternatively, R¹¹ and R¹² join to form C₃₋₇ cycloalkyl;

R¹⁴, at each occurrence, is selected from C₁₋₈ alkyl, (CH₂)_rC₃₋₆ cycloalkyl, CF₃, Cl, Br, I, F, 30 (CH₂)_rNR^{14a}R^{14a'}, NO₂, CN, OH, (CH₂)_rOR^{14d}, (CH₂)_rC(O)R^{14b}, (CH₂)_rC(O)NR^{14a}R^{14a'}, (CH₂)_rNR^{14f}C(O)R^{14b}, (CH₂)_rS(O)_pR^{14b}, (CH₂)_rS(O)₂NR^{14a}R^{14a'}, (CH₂)_rNR^{14f}S(O)₂R^{14b}, (CH₂)_rphenyl substituted with 0-3 R^{14e};

35

R^{14a} and R^{14a'}, at each occurrence, are selected from H, C₁₋₆ alkyl, C₃₋₆ cycloalkyl, and (CH₂)_rphenyl substituted

with 0-3 R^{14e}, and a (CH₂)_r-5-6 membered heterocyclic system containing 1-4 heteroatoms selected from N, O, and S, substituted with 0-2 R^{15e};

5 R^{14b}, at each occurrence, is selected from H, C₁₋₆ alkyl, C₃₋₆ cycloalkyl, and (CH₂)_rphenyl substituted with 0-3 R^{14e};

10 R^{14d}, at each occurrence, is selected from C₁₋₆ alkyl and phenyl;

R^{14e}, at each occurrence, is selected from C₁₋₆ alkyl, Cl, F, Br, I, CN, NO₂, (CF₂)_rCF₃, OH, and (CH₂)_rOC₁₋₅ alkyl; and

15 R^{14f}, at each occurrence, is selected from H, and C₁₋₅ alkyl; and

r is selected from 0, 1, and 2.

20 [35] In a preferred embodiment, the present invention provides novel compounds of formula (I-ii), wherein:

R⁵ is CH₂phenyl substituted with 0-3 R¹⁶;

25 R⁹, is selected from H, C₁₋₆ alkyl, (CH₂)_rC₃₋₆ cycloalkyl, F, Cl, CN, (CH₂)_rOH, (CH₂)_rOR^{9d}, (CH₂)_rNR^{9a}R^{9a'}, (CH₂)_rOC(O)NHR^{9a}, (CH₂)_rphenyl substituted with 0-5 R^{9e}, and a heterocyclic system substituted with 0-2 R^{9e},
30 wherein the heterocyclic system is selected from pyridyl, thiophenyl, furanyl, oxazolyl, and thiazolyl;

R^{9a} and R^{9a'}, at each occurrence, are selected from H, C₁₋₆ alkyl, C₃₋₆ cycloalkyl, and (CH₂)_rphenyl substituted
35 with 0-3 R^{9e};

R^{9d}, at each occurrence, is selected from C₁₋₆ alkyl and phenyl;

5 R^{9e}, at each occurrence, is selected from C₁₋₆ alkyl, Cl, F, Br, I, CN, NO₂, (CF₂)_rCF₃, OH, and (CH₂)_rOC₁₋₅ alkyl;

R¹⁰ is selected from H, C₁₋₈ alkyl, OH, and CH₂OH;

10 alternatively, R⁹ and R¹⁰ join to form C₃₋₇ cycloalkyl, 5-6-membered cyclic ketal or =O;

with the proviso that when R¹⁰ is -OH, R⁹ is not halogen, cyano, or bonded to the carbon to which it is attached through a heteroatom;

15

R¹¹ is selected from H, C₁₋₈ alkyl, (CH₂)_rphenyl substituted with 0-5 R^{11e}, and a (CH₂)_r-heterocyclic system substituted with 0-2 R^{11e}, wherein the heterocyclic system is selected from pyridinyl, thiophenyl, furanyl, indazolyl, benzothiazolyl, benzimidazolyl, benzothiophenyl, benzofuranyl, benzoxazolyl, benzisoxazolyl, quinolinyl, isoquinolinyl, imidazolyl, indolyl, isoindolyl, piperidinyl, pyrrolazolyl, 1,2,4-triazolyl, 1,2,3-triazolyl, tetrazolyl, thiazolyl, oxazolyl, pyrazinyl, and pyrimidinyl; and

20

25

R^{11e}, at each occurrence, is selected from C₁₋₆ alkyl, Cl, F, Br, I, CN, NO₂, (CF₂)_rCF₃, OH, and (CH₂)_rOC₁₋₅ alkyl;

30 R¹² is H;

alternatively, R¹¹ and R¹² join to form C₃₋₇ cycloalkyl;

35 R¹⁴, at each occurrence, is selected from C₁₋₈ alkyl, (CH₂)_rC₃₋₆ cycloalkyl, CF₃, Cl, Br, I, F, (CH₂)_rNR^{14a}R^{14a'}, NO₂, CN, OH, (CH₂)_rOR^{14d}, (CH₂)_rC(O)R^{14b}, (CH₂)_rC(O)NR^{14a}R^{14a'}, (CH₂)_rNR^{14f}C(O)R^{14b},

(CH₂)_rS(O)_pR^{14b}, (CH₂)_rS(O)₂NR^{14a}R^{14a'},
(CH₂)_rNR^{14f}S(O)₂R^{14b}, (CH₂)_rphenyl substituted with 0-3
R^{14e}, and a (CH₂)_r-5-6 membered heterocyclic system
containing 1-4 heteroatoms selected from N, O, and S,
5 substituted with 0-2 R^{15e};

R^{14a} and R^{14a'}, at each occurrence, are selected from H, C₁₋₆
alkyl, C₃₋₆ cycloalkyl, and (CH₂)_rphenyl substituted
with 0-3 R^{14e};

10 R^{14b}, at each occurrence, is selected from H, C₁₋₆ alkyl,
C₃₋₆ cycloalkyl, and (CH₂)_rphenyl substituted with 0-3
R^{14e};

15 R^{14d}, at each occurrence, is selected from C₁₋₆ alkyl and
phenyl;

R^{14e}, at each occurrence, is selected from C₁₋₆ alkyl, Cl,
F, Br, I, CN, NO₂, (CF₂)_rCF₃, OH, and (CH₂)_rOC₁₋₅ alkyl;

20 R^{14f}, at each occurrence, is selected from H, and C₁₋₅
alkyl; and

r is selected from 0, 1, and 2.

25

[36] In a more preferred embodiment, the present invention
provides novel compounds of formula (I-i), wherein:

J is selected from CH₂ and CHR⁵;

30

K is selected from CH₂ and CHR⁵;

L is selected from CH₂ and CHR⁵;

35 R³ is a C₃₋₁₀ carbocyclic residue substituted with 0-3 R¹⁵,
wherein the carbocyclic residue is selected from
cyclopropyl, cyclopentyl, cyclohexyl, phenyl, naphthyl

and adamantyl, and a $(CR^{3'}H)_r$ -heterocyclic system substituted with 0-3 R^{15} , wherein the heterocyclic system is selected from pyridinyl, thiophenyl, furanyl, indazolyl, benzothiazolyl, benzimidazolyl, 5 benzothiophenyl, benzofuranyl, benzoxazolyl, benzisoxazolyl, quinolinyl, isoquinolinyl, imidazolyl, indolyl, indolinyl, isoindolyl, isothiadiazolyl, isoxazolyl, piperidinyl, pyrrazolyl, 1,2,4-triazolyl, 1,2,3-triazolyl, tetrazolyl, thiadiazolyl, thiazolyl, 10 oxazolyl, pyrazinyl, and pyrimidinyl; and

R^{15} , at each occurrence, is selected from C_{1-8} alkyl, $(CH_2)_rC_{3-6}$ cycloalkyl, CF_3 , Cl, Br, I, F, $(CH_2)_rNR^{15a}R^{15a'}$, NO_2 , CN, OH, $(CH_2)_rOR^{15d}$, 15 $(CH_2)_rC(O)R^{15b}$, $(CH_2)_rC(O)NR^{15a}R^{15a'}$, $(CH_2)_rNR^{15f}C(O)R^{15b}$, $(CH_2)_rS(O)_pR^{15b}$, $(CH_2)_rS(O)_2NR^{15a}R^{15a'}$, $(CH_2)_rNR^{15f}S(O)_2R^{15b}$, $(CH_2)_r$ phenyl substituted with 0-3 R^{15e} , and a $(CH_2)_r$ -5-6 membered heterocyclic system containing 1-4 heteroatoms selected from N, O, and S, 20 substituted with 0-2 R^{15e} ;

R^{15a} and $R^{15a'}$, at each occurrence, are selected from H, C_{1-6} alkyl, C_{3-6} cycloalkyl, and $(CH_2)_r$ phenyl substituted with 0-3 R^{15e} ; 25

R^{15b} , at each occurrence, is selected from H, C_{1-6} alkyl, C_{3-6} cycloalkyl, and $(CH_2)_r$ phenyl substituted with 0-3 R^{15e} ;

R^{15d} , at each occurrence, is selected from C_{1-6} alkyl and phenyl; 30

R^{15e} , at each occurrence, is selected from C_{1-6} alkyl, Cl, F, Br, I, CN, NO_2 , $(CF_2)_rCF_3$, OH, and $(CH_2)_rOC_{1-5}$ alkyl; 35 and

R^{15f} , at each occurrence, is selected from H, and C_{1-5} alkyl.

[37] In a more preferred embodiment, the present invention provides novel compounds of formula (I-ii), wherein:

K is selected from CH_2 and CHR^5 ;

L is selected from CH_2 and CHR^5 ;

10

R^3 is a C_{3-10} carbocyclic residue substituted with 0-3 R^{15} , wherein the carbocyclic residue is selected from cyclopropyl, cyclopentyl, cyclohexyl, phenyl, naphthyl and adamantyl, and a $(CR^{3'}H)_r$ -heterocyclic system substituted with 0-3 R^{15} , wherein the heterocyclic system is selected from pyridinyl, thiophenyl, furanyl, indazolyl, benzothiazolyl, benzimidazolyl, benzothiophenyl, benzofuranyl, benzoxazolyl, benzisoxazolyl, quinolinyl, isoquinolinyl, imidazolyl, indolyl, indolinyl, isoindolyl, isothiadiazolyl, isoxazolyl, piperidinyl, pyrrolazolyl, 1,2,4-triazolyl, 1,2,3-triazolyl, tetrazolyl, thiadiazolyl, thiazolyl, oxazolyl, pyrazinyl, and pyrimidinyl; and

15

20

R^{15} , at each occurrence, is selected from C_{1-8} alkyl, $(CH_2)_r C_{3-6}$ cycloalkyl, CF_3 , Cl, Br, I, F, $(CH_2)_r NR^{15a}R^{15a'}$, NO_2 , CN, OH, $(CH_2)_r OR^{15d}$, $(CH_2)_r C(O)R^{15b}$, $(CH_2)_r C(O)NR^{15a}R^{15a'}$, $(CH_2)_r NR^{15f}C(O)R^{15b}$, $(CH_2)_r S(O)_p R^{15b}$, $(CH_2)_r S(O)_2 NR^{15a}R^{15a'}$, $(CH_2)_r NR^{15f}S(O)_2 R^{15b}$, and $(CH_2)_r$ phenyl substituted with 0-3 R^{15e} , and a $(CH_2)_r$ -5-6 membered heterocyclic system containing 1-4 heteroatoms selected from N, O, and S, substituted with 0-2 R^{15e} ;

30

R^{15a} and $R^{15a'}$, at each occurrence, are selected from H, C_{1-6} alkyl, C_{3-6} cycloalkyl, and $(CH_2)_r$ phenyl substituted with 0-3 R^{15e} ;

35

R^{15b}, at each occurrence, is selected from H, C₁₋₆ alkyl, C₃₋₆ cycloalkyl, and (CH₂)_rphenyl substituted with 0-3 R^{15e};

5

R^{15d}, at each occurrence, is selected from C₁₋₆ alkyl and phenyl;

10 R^{15e}, at each occurrence, is selected from C₁₋₆ alkyl, Cl, F, Br, I, CN, NO₂, (CF₂)_rCF₃, OH, and (CH₂)_rOC₁₋₅ alkyl; and

R^{15f}, at each occurrence, is selected from H and C₁₋₅ alkyl.

15 [38] In a further even more preferred embodiment, the present invention provides novel compounds of formula (I) and pharmaceutically acceptable salt forms thereof, wherein the compound of formula (I) is selected from

20 N"-cyano-N-(3-acetylphenyl)-N'-[(1R,2S)-2-[[[(3S)-3-(4-fluorobenzyl)piperidinyl]methyl]cyclohexyl]guanidine,

N"-cyano-N-(4-((1H)-1-methyl-tetrazol-5-yl)phenyl)-N'-[(1R,2S)-2-[[[(3S)-3-(4-fluorobenzyl)piperidinyl]methyl]cyclohexyl]guanidine,

25

N"-cyano-N-(3-acetylphenyl)-N'-[(1R,2S)-2-[[4-(4-fluorobenzyl)piperidinyl]methyl]cyclohexyl]guanidine,

30 N"-cyano-N-(phenyl)-N'-[(1R,2S)-2-[[4-(4-fluorobenzyl)piperidinyl]methyl]cyclohexyl]guanidine,

N"-cyano-N-(phenyl)-N'-[(1R,2S)-2-[[[(3S)-3-(4-fluorobenzyl)piperidinyl]methyl]cyclohexyl]guanidine,

35

N"-cyano-N-(3-cyanophenyl)-N'-[(1R,2S)-2-[[[(3S)-3-(4-fluorobenzyl)piperidinyl]methyl]cyclohexyl]guanidine,

- N"-cyano-N-(3-cyanophenyl)-N'-[(1R,2S)-2-[[4-(4-fluorobenzyl)piperidinyl]methyl]cyclohexyl]guanidine,
- 5 N"-cyano-N-(2,4-dimethoxyphenyl)-N'-[(1R,2S)-2-[[3-(4-fluorobenzyl)piperidinyl]methyl]cyclohexyl]guanidine,
- N"-cyano-N-(2,5-dimethoxyphenyl)-N'-[(1R,2S)-2-[[3-(4-fluorobenzyl)piperidinyl]methyl]cyclohexyl]guanidine,
- 10 N"-cyano-N-(4-((1H)-1-propyl-tetrazol-5-yl)phenyl)-N'-[(1R,2S)-2-[[3-(4-fluorobenzyl)piperidinyl]methyl]cyclohexyl]guanidine,
- 15 N"-cyano-N-(1-adamantyl)-N'-[(1R,2S)-2-[[3-(4-fluorobenzyl)piperidinyl]methyl]cyclohexyl]guanidine,
- N"-cyano-N-(2-adamantyl)-N'-[(1R,2S)-2-[[3-(4-fluorobenzyl)piperidinyl]methyl]cyclohexyl]guanidine,
- 20 N"-cyano-N-(ethoxycarbonylmethyl)-N'-[(1R,2S)-2-[[3-(4-fluorobenzyl)piperidinyl]methyl]cyclohexyl]guanidine,
- 25 N"-cyano-N-(5,6,7,8-tetrahydronaphth-1-yl)-N'-[(1R,2S)-2-[[3-(4-fluorobenzyl)piperidinyl]methyl]cyclohexyl]guanidine,
- N"-cyano-N-(2,4-dimethylphenyl)-N'-[(1R,2S)-2-[[3-(4-fluorobenzyl)piperidinyl]methyl]cyclohexyl]guanidine,
- 30 N"-cyano-N-(2-methoxyphenyl)-N'-[(1R,2S)-2-[[3-(4-fluorobenzyl)piperidinyl]methyl]cyclohexyl]guanidine,
- 35 N"-cyano-N-(2-methyl-4-hydroxyphenyl)-N'-[(1R,2S)-2-[[3-(4-fluorobenzyl)piperidinyl]methyl]cyclohexyl]guanidine,

- N"-cyano-N-(2,5-dimethylphenyl)-N'-[(1R,2S)-2-[[(3S)-3-(4-fluorobenzyl)piperidinyl]methyl]cyclohexyl]guanidine,
- 5 N"-cyano-N-(2-phenylethyl)-N'-[(1R,2S)-2-[[(3S)-3-(4-fluorobenzyl)piperidinyl]methyl]cyclohexyl]guanidine,
- N"-cyano-N-(5-acetyl-2-methoxyphenyl)-N'-[(1R,2S)-2-[[(3S)-3-(4-fluorobenzyl)piperidinyl]methyl]cyclohexyl]guanidine,
- 10 N"-cyano-N-[4-(4-morpholinyl)phenyl]-N'-[(1R,2S)-2-[[(3S)-3-(4-fluorobenzyl)piperidinyl]methyl]cyclohexyl]guanidine,
- 15 2-[(3-acetylanilino)[(1R,2S)-2-[[(3S)-3-(4-fluorobenzyl)piperidinyl]methyl]cyclohexyl]amino)methylene]malonitrile,
- 20 2-[(5-acetyl-2-methoxyanilino)[(1R,2S)-2-[[(3S)-3-(4-fluorobenzyl)piperidinyl]methyl]cyclohexyl]amino)methylene]malonitrile,
- 1-[3-([1-[[(1R,2S)-2-[[(3S)-3-(4-fluorobenzyl)piperidinyl]methyl]cyclohexyl]amino]-2-nitroethenyl]amino)phenyl]ethanone,
- 25 1-[3-([1-[[(2-[[4-(4-fluorobenzyl)piperidinyl]methyl]phenyl]amino]-2-nitroethenyl]amino)phenyl]ethanone,
- 30 N"-cyano-N-(3,5-diacetylphenyl)-1-N'-[2-[[4-(4-fluorobenzyl)piperidinyl]methyl]3-(N-methylcarbamoyl)phenyl]guanidine,
- 35

N"-cyano-N-(3-diacetylphenyl)-1-N'-[2-[[4-(4-fluorobenzyl)piperidinyl]methyl]3-(N-methylcarbamoyl)phenyl]guanidine, and

5 N"-cyano-N-[3-[(1H)-1-methyltetrazol-5-yl]phenyl]-1-N'-[2-[[4-(4-fluorobenzyl)piperidinyl]methyl]3-(N-methylcarbamoyl)phenyl]guanidine.

10 In another embodiment, the present invention provides a pharmaceutical composition, comprising a pharmaceutically acceptable carrier and a therapeutically effective amount of a compound of the present invention.

15 In another embodiment, the present invention provides a method for modulation of chemokine receptor activity comprising administering to a patient in need thereof a therapeutically effective amount of a compound of the present invention.

20 In another embodiment, the present invention provides a method for treating inflammatory disorders comprising administering to a patient in need thereof a therapeutically effective amount of a compound of the present invention

25 In another embodiment, the present invention provides a method for treating or preventing disorders selected from asthma, allergic rhinitis, atopic dermatitis, inflammatory bowel diseases, idiopathic pulmonary fibrosis, bullous pemphigoid, helminthic parasitic infections, allergic colitis, eczema, conjunctivitis, transplantation, familial eosinophilia, eosinophilic cellulitis, eosinophilic pneumonias, eosinophilic fasciitis, eosinophilic gastroenteritis, drug induced eosinophilia, HIV infection, 30 cystic fibrosis, Churg-Strauss syndrome, lymphoma, 35 Hodgkin's disease, and colonic carcinoma.

DEFINITIONS

The compounds herein described may have asymmetric centers. Compounds of the present invention containing an asymmetrically substituted atom may be isolated in
5 optically active or racemic forms. It is well known in the art how to prepare optically active forms, such as by resolution of racemic forms or by synthesis from optically active starting materials. Many geometric isomers of olefins, C=N double bonds, and the like can also be present
10 in the compounds described herein, and all such stable isomers are contemplated in the present invention. Cis and trans geometric isomers of the compounds of the present invention are described and may be isolated as a mixture of isomers or as separated isomeric forms. All chiral,
15 diastereomeric, racemic forms and all geometric isomeric forms of a structure are intended, unless the specific stereochemistry or isomeric form is specifically indicated.

The term "substituted," as used herein, means that any one or more hydrogens on the designated atom is replaced
20 with a selection from the indicated group, provided that the designated atom's normal valency is not exceeded, and that the substitution results in a stable compound. When a substituent is keto (i.e., =O), then 2 hydrogens on the atom are replaced.

25 When any variable (e.g., R^a) occurs more than one time in any constituent or formula for a compound, its definition at each occurrence is independent of its definition at every other occurrence. Thus, for example, if a group is shown to be substituted with 0-2 R^a, then
30 said group may optionally be substituted with up to two R^a groups and R^a at each occurrence is selected independently from the definition of R^a. Also, combinations of substituents and/or variables are permissible only if such combinations result in stable compounds.

35 When a bond to a substituent is shown to cross a bond connecting two atoms in a ring, then such substituent may be bonded to any atom on the ring. When a substituent is

listed without indicating the atom via which such substituent is bonded to the rest of the compound of a given formula, then such substituent may be bonded via any atom in such substituent. Combinations of substituents and/or variables are permissible only if such combinations result in stable compounds.

As used herein, "C₁₋₈ alkyl" is intended to include both branched and straight-chain saturated aliphatic hydrocarbon groups having the specified number of carbon atoms, examples of which include, but are not limited to, methyl, ethyl, n-propyl, i-propyl, n-butyl, i-butyl, sec-butyl, t-butyl, pentyl, and hexyl. C₁₋₈ alkyl, is intended to include C₁, C₂, C₃, C₄, C₅, C₆, C₇, and C₈ alkyl groups. "Alkenyl" is intended to include hydrocarbon chains of either a straight or branched configuration and one or more unsaturated carbon-carbon bonds which may occur in any stable point along the chain, such as ethenyl, propenyl, and the like. "Alkynyl" is intended to include hydrocarbon chains of either a straight or branched configuration and one or more unsaturated triple carbon-carbon bonds which may occur in any stable point along the chain, such as ethynyl, propynyl, and the like. "C₃₋₆ cycloalkyl" is intended to include saturated ring groups having the specified number of carbon atoms in the ring, including mono-, bi-, or poly-cyclic ring systems, such as cyclopropyl, cyclobutyl, cyclopentyl, cyclohexyl, and cycloheptyl in the case of C₇ cycloalkyl. C₃₋₆ cycloalkyl, is intended to include C₃, C₄, C₅, and C₆ cycloalkyl groups

"Halo" or "halogen" as used herein refers to fluoro, chloro, bromo, and iodo; and "haloalkyl" is intended to include both branched and straight-chain saturated aliphatic hydrocarbon groups, for example CF₃, having the specified number of carbon atoms, substituted with 1 or more halogen (for example -C_vF_w where v = 1 to 3 and w = 1 to (2v+1)).

The compounds of Formula I can also be quaternized by standard techniques such as alkylation of the piperidine or

pyrrolidine with an alkyl halide to yield quaternary piperidinium salt products of Formula I. Such quaternary piperidinium salts would include a counterion. As used herein, "counterion" is used to represent a small,
5 negatively charged species such as chloride, bromide, hydroxide, acetate, sulfate, and the like.

As used herein, the term "piperidinium spirocycle or pyrrolidinium spirocycle" is intended to mean a stable spirocycle ring system, in which the two rings form a
10 quaternary nitrogen at the ring junction.

As used herein, the term "5-6-membered cyclic ketal" is intended to mean 2,2-disubstituted 1,3-dioxolane or 2,2-disubstituted 1,3-dioxane and their derivatives.

As used herein, "carbocycle" or "carbocyclic residue"
15 is intended to mean any stable 3, 4, 5, 6, or 7-membered monocyclic or bicyclic or 7, 8, 9, 10, 11, 12, or 13-membered bicyclic or tricyclic, any of which may be saturated, partially unsaturated, or aromatic. Examples of such carbocycles include, but are not limited to,
20 cyclopropyl, cyclobutyl, cyclopentyl, cyclohexyl, cycloheptyl, adamantyl, cyclooctyl,; [3.3.0]bicyclooctane, [4.3.0]bicyclononane, [4.4.0]bicyclodecane (decalin), [2.2.2]bicyclooctane, fluorenyl, phenyl, naphthyl, indanyl, adamantyl, or tetrahydronaphthyl (tetralin).

25 As used herein, the term "heterocycle" or "heterocyclic system" is intended to mean a stable 5, 6, or 7-membered monocyclic or bicyclic or 7, 8, 9, or 10-membered bicyclic heterocyclic ring which is saturated, partially unsaturated or unsaturated (aromatic), and which
30 consists of carbon atoms and 1, 2, 3, or 4 heteroatoms independently selected from the group consisting of N, NH, O and S and including any bicyclic group in which any of the above-defined heterocyclic rings is fused to a benzene ring. The nitrogen and sulfur heteroatoms may optionally
35 be oxidized. The heterocyclic ring may be attached to its pendant group at any heteroatom or carbon atom which results in a stable structure. The heterocyclic rings

described herein may be substituted on carbon or on a nitrogen atom if the resulting compound is stable. If specifically noted, a nitrogen in the heterocycle may optionally be quaternized. It is preferred that when the total number of S and O atoms in the heterocycle exceeds 1, then these heteroatoms are not adjacent to one another. As used herein, the term "aromatic heterocyclic system" is intended to mean a stable 5- to 7- membered monocyclic or bicyclic or 7- to 10-membered bicyclic heterocyclic aromatic ring which consists of carbon atoms and from 1 to 4 heteroatoms independently selected from the group consisting of N, O and S.

Examples of heterocycles include, but are not limited to, 1H-indazole, 2-pyrrolidinyl, 2H,6H-1,5,2-dithiazinyl, 2H-pyrrolyl, 3H-indolyl, 4-piperidinyl, 4aH-carbazole, 4H-quinolizinyl, 6H-1,2,5-thiadiazinyl, acridinyl, azocinyl, benzimidazolyl, benzofuranyl, benzothiofuranyl, benzothiophenyl, benzoxazolyl, benzthiazolyl, benztriazolyl, benztetrazolyl, benzisoxazolyl, benzisothiazolyl, benzimidazolyl, carbazolyl, 4aH-carbazolyl, β -carbolinyl, chromanyl, chromenyl, cinnolinyl, decahydroquinolinyl, 2H,6H-1,5,2-dithiazinyl, dihydrofuro[2,3-b]tetrahydrofuran, furanyl, furazanyl, imidazolidinyl, imidazolyl, imidazolyl, 1H-indazolyl, indolenyl, indolinyl, indolizinyl, indolyl, isobenzofuranyl, isochromanyl, isoindazolyl, isoindolinyl, isoindolyl, isoquinolinyl (benzimidazolyl), isothiazolyl, isoxazolyl, morpholinyl, naphthyridinyl, octahydroisoquinolinyl, oxadiazolyl, 1,2,3-oxadiazolyl, 1,2,4-oxadiazolyl, 1,2,5-oxadiazolyl, 1,3,4-oxadiazolyl, oxazolidinyl, oxazolyl, oxazolidinylperimidinyl, phenanthridinyl, phenanthrolinyl, phenarsazinyl, phenazinyl, phenothiazinyl, phenoxathiinyl, phenoxazinyl, phthalazinyl, piperazinyl, piperidinyl, pteridinyl, piperidinyl, 4-piperidinyl, pteridinyl, purinyl, pyranyl, pyrazinyl, pyrazolidinyl, pyrazolinyl, pyrazolyl, pyridazinyl, pyridoxazole, pyridoimidazole,

pyridothiazole, pyridinyl, pyridyl, pyrimidinyl,
pyrrolidinyl, pyrrolinyl, pyrrolyl, quinazolinyl,
quinolinyl, 4*H*-quinolizinyll, quinoxalinyl, quinuclidinyl,
carbolinyl, tetrahydrofuranlyl, tetrahydroisoquinolinyl,
5 tetrahydroquinolinyl, 6*H*-1,2,5-thiadiazinyl, 1,2,3-
thiadiazolyl, 1,2,4-thiadiazolyl, 1,2,5-thiadiazolyl,
1,3,4-thiadiazolyl, thianthrenyl, thiazolyl, thienyl,
thienothiazolyl, thienooxazolyl, thienoimidazolyl,
thiophenyl, triazinyl, 1,2,3-triazolyl, 1,2,4-triazolyl,
10 1,2,5-triazolyl, 1,3,4-triazolyl, tetrazolyl, and
xanthenyl. Preferred heterocycles include, but are not
limited to, pyridinyl, thiophenyl, furanyl, indazolyl,
benzothiazolyl, benzimidazolyl, benzothiaphenyl,
benzofuranlyl, benzoxazolyl, benzisoxazolyl, quinolinyl,
15 isoquinolinyl, imidazolyl, indolyl, isoidolyl, piperidinyl,
piperidonyl, 4-piperidonyl, piperonyl, pyrrazolyl, 1,2,4-
triazolyl, 1,2,3-triazolyl, tetrazolyl, thiazolyl,
oxazolyl, pyrazinyl, and pyrimidinyl. Also included are
fused ring and spiro compounds containing, for example, the
20 above heterocycles.

The phrase "pharmaceutically acceptable" is employed
herein to refer to those compounds, materials,
compositions, and/or dosage forms which are, within the
scope of sound medical judgment, suitable for use in
25 contact with the tissues of human beings and animals
without excessive toxicity, irritation, allergic response,
or other problem or complication, commensurate with a
reasonable benefit/risk ratio.

As used herein, "pharmaceutically acceptable salts"
30 refer to derivatives of the disclosed compounds wherein the
parent compound is modified by making acid or base salts
thereof. Examples of pharmaceutically acceptable salts
include, but are not limited to, mineral or organic acid
salts of basic residues such as amines; alkali or organic
35 salts of acidic residues such as carboxylic acids; and the
like. The pharmaceutically acceptable salts include the
conventional non-toxic salts or the quaternary ammonium

salts of the parent compound formed, for example, from non-toxic inorganic or organic acids. For example, such conventional non-toxic salts include those derived from inorganic acids such as hydrochloric, hydrobromic, 5 sulfuric, sulfamic, phosphoric, nitric and the like; and the salts prepared from organic acids such as acetic, propionic, succinic, glycolic, stearic, lactic, malic, tartaric, citric, ascorbic, pamoic, maleic, hydroxymaleic, phenylacetic, glutamic, benzoic, salicylic, sulfanilic, 2- 10 acetoxybenzoic, fumaric, toluenesulfonic, methanesulfonic, ethane disulfonic, oxalic, isethionic, and the like.

The pharmaceutically acceptable salts of the present invention can be synthesized from the parent compound which contains a basic or acidic moiety by conventional chemical 15 methods. Generally, such salts can be prepared by reacting the free acid or base forms of these compounds with a stoichiometric amount of the appropriate base or acid in water or in an organic solvent, or in a mixture of the two; generally, nonaqueous media like ether, ethyl acetate, 20 ethanol, isopropanol, or acetonitrile are preferred. Lists of suitable salts are found in *Remington's Pharmaceutical Sciences*, 17th ed., Mack Publishing Company, Easton, PA, 1985, p. 1418, the disclosure of which is hereby incorporated by reference.

25 Since prodrugs are known to enhance numerous desirable qualities of pharmaceuticals (e.g., solubility, bioavailability, manufacturing, etc...) the compounds of the present invention may be delivered in prodrug form. Thus, the present invention is intended to cover prodrugs 30 of the presently claimed compounds, methods of delivering the same and compositions containing the same. "Prodrugs" are intended to include any covalently bonded carriers which release an active parent drug of the present invention *in vivo* when such prodrug is administered to a 35 mammalian subject. Prodrugs the present invention are prepared by modifying functional groups present in the compound in such a way that the modifications are cleaved,

either in routine manipulation or *in vivo*, to the parent compound. Prodrugs include compounds of the present invention wherein a hydroxy, amino, or sulfhydryl group is bonded to any group that, when the prodrug of the present invention is administered to a mammalian subject, it cleaves to form a free hydroxyl, free amino, or free sulfhydryl group, respectively. Examples of prodrugs include, but are not limited to, acetate, formate and benzoate derivatives of alcohol and amine functional groups in the compounds of the present invention.

"Stable compound" and "stable structure" are meant to indicate a compound that is sufficiently robust to survive isolation to a useful degree of purity from a reaction mixture, and formulation into an efficacious therapeutic agent.

SYNTHESIS

The compounds of Formula I can be prepared using the reactions and techniques described below. The reactions are performed in a solvent appropriate to the reagents and materials employed and suitable for the transformations being effected. It will be understood by those skilled in the art of organic synthesis that the functionality present on the molecule should be consistent with the transformations proposed. This will sometimes require a judgment to modify the order of the synthetic steps or to select one particular process scheme over another in order to obtain a desired compound of the invention. It will also be recognized that another major consideration in the planning of any synthetic route in this field is the judicious choice of the protecting group used for protection of the reactive functional groups present in the compounds described in this invention. An authoritative account describing the many alternatives to the trained practitioner is Greene and Wuts (*Protective Groups In Organic Synthesis*, Wiley and Sons, 1991).

Generally, compounds described in the scope of this patent application can be synthesized by the route described in Scheme 1. The appropriately substituted pyrrolidine (n=0) or piperidine (n=1) 1 is alkylated by a N-protected alkylhalide (halide = Cl, Br, I), mesylate, tosylate or triflate, 2, (where E represents a linkage described within the scope of this application in its fully elaborated form with the appropriate protecting groups as understood by one skilled in the art or in a precursor form which can be later elaborated into its final form by methods familiar to one skilled in the art) with or without base or an acid scavenger to yield the piperidinyl- or pyrrolidinylalkyl protected amine 3. If the halide is not I, then KI can also be added to facilitate the displacement, provided the solvent is suitable, such as an alcohol, 2-butanone, DMF or DMSO, amongst others. The displacement can be performed at room temperature to the reflux temperature of the solvent. The protecting group is subsequently removed to yield amine 4. Protecting groups include phthalimide which can be removed by hydrazine, a reaction familiar to one skilled in the art; bis-BOC which can be removed by either TFA or HCl dissolved in a suitable solvent, both procedures being familiar to one skilled in the art; a nitro group instead of an amine which can be reduced to yield an amine by conditions familiar to one skilled in the art; 2,4-dimethyl pyrrole (S. P. Breukelman, et al. J. Chem. Soc. Perkin Trans. I, 1984, 2801); N-1,1,4,4-Tetramethyl-disilylazacyclopentane (STABASE) (S. Djuric, J. Venit, and P. Magnus Tet. Lett 1981, 22, 1787) and other protecting groups. Reaction with an isocyanate or isothiocyanate 5 (Z = O,S) yields urea or thiourea 6. Reaction with a chloroformate or chlorothioformate 7 (Z=O,S) such as o-, p-nitrophenyl-chloroformate or phenylchloroformate (or their thiocarbonyl equivalents), followed by displacement with an amine 9, also yields the corresponding urea or thiourea 6. Likewise, reaction of carbamate 8 (X = H, or 2- or 4-NO₂) with disubstituted

amine 10 yields trisubstituted urea or thiourea 12.
Reaction of the amine 4 with an N,N-disubstituted carbamoyl chloride 11 (or its thiocarbonyl equivalent) yields the corresponding N,N-disubstituted urea or thiourea 12.

5 Amine 4 can also be reductively aminated to yield 13 by conditions familiar to one skilled in the art and by the following conditions: Abdel-Magid, A. F., et al. Tet. Lett. 1990, 31, (39) 5595-5598. This secondary amine can subsequently be reacted with isocyanates or isothiocyanates

10 to yield trisubstituted ureas 14 or with carbamoyl chlorides to yield tetrasubstituted ureas 15.

SCHEME 1

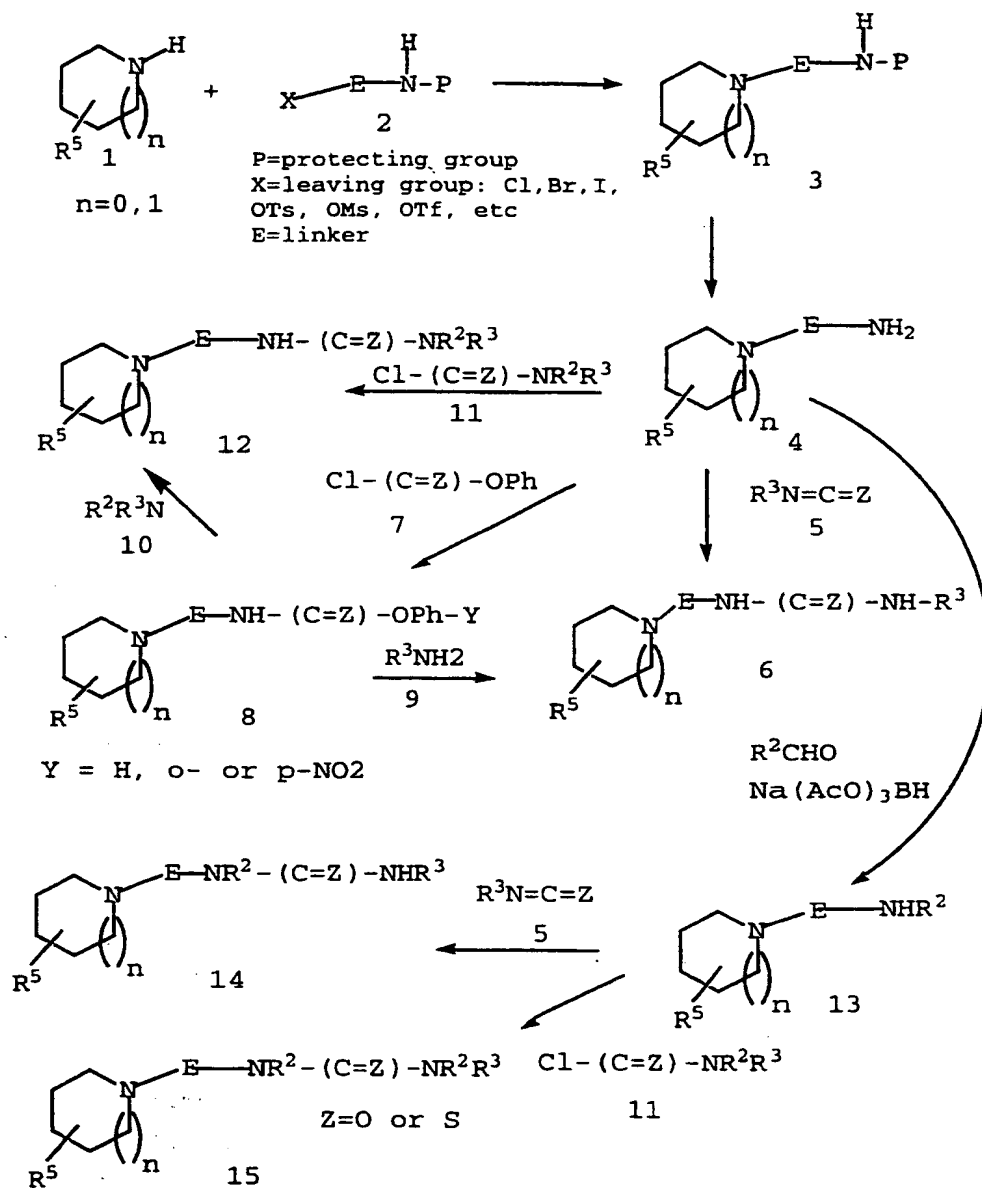

One can also convert amine 4 into an isocyanate,
 isothiocyanate, carbamoyl chloride or its thiocarbonyl
 equivalent (isocyanate: Nowakowski, J. J Prakt. Chem/Chem-
 Ztg 1996, 338 (7), 667-671; Knoelker, H.-J. et al., Angew.
 Chem. 1995, 107 (22), 2746-2749; Nowick, J. S. et al., J.
 Org. Chem. 1996, 61 (11), 3929-3934; Staab, H. A.; Benz,

W.; Angew Chem 1961, 73; isothiocyanate: Streckowski L. et al., J. Heterocycl. Chem. 1996, 33 (6), 1685-1688; Kutschy, Pet al., Synlett. 1997, (3), 289-290) carbamoyl chloride: Hintze, F.; Hoppe, D.; Synthesis (1992) 12, 1216-1218; thiocarbamoyl chloride: Ried, W.; Hillenbrand, H.; Oertel, G.; Justus Liebigs Ann Chem 1954, 590) (these reactions are not shown in Scheme 1). These isocyanates, isothiocyanates, carbamoyl chlorides or thiocarbamoyl chlorides can then be reacted with R^2R^3NH to yield di- or trisubstituted ureas or thioureas 12. An additional urea forming reaction involves the reaction of carbonyldiimidazole (CDI) (Romine, J. L.; Martin, S. W.; Meanwell, N. A.; Epperson, J. R.; Synthesis 1994 (8), 846-850) with 4 followed by reaction of the intermediate imidazolide with 9 or in the reversed sequence (9 + CDI, followed by 4). Activation of imidazolide intermediates also facilitates urea formation (Bailey, R. A., et al., Tet. Lett. 1998, 39, 6267-6270). One can also use 13 and 10 with CDI. The urea forming reactions are done in a non-hydroxylic inert solvent such as THF, toluene, DMF, etc., at room temperature to the reflux temperature of the solvent and can employ the use of an acid scavenger or base when necessary such as carbonate and bicarbonate salts, triethylamine, DBU, Hunigs base, DMAP, etc.

Substituted pyrrolidines and piperidines 1 can either be obtained commercially or be prepared as shown in Scheme 2. Commercially available N-benzylpiperid-3-one 16 can be debenzylated and protected with a BOC group employing reactions familiar to one skilled in the art. Subsequent Wittig reaction followed by reduction and deprotection yields piperidine 20 employing reactions familiar to one skilled in the art. Substituted pyrrolidines may be made by a similar reaction sequence. Other isomers and analogs around the piperidine ring can also be made by a similar reaction sequence. Chiral pyrrolidines/piperidines can be synthesized via asymmetric hydrogenation of 18 using chiral catalysts (see Parshall, G.W. Homogeneous Catalysis, John

Wiley and Sons, New York: 1980, pp. 43-45; Collman, J.P., Hegedus, L.S. Principles and Applications of Organotransition Metal Chemistry, University Science Books, Mill Valley, CA, 1980, pp. 341-348).

5

SCHEME 2

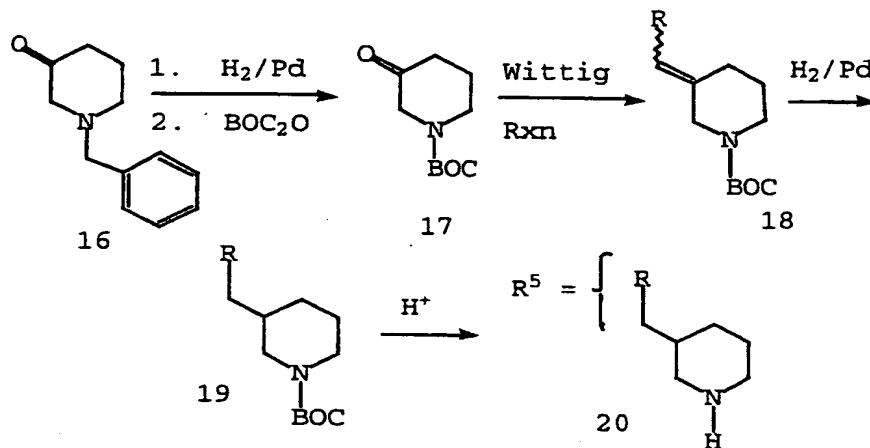

The cyanoguanidines (Z = N-CN) can be synthesized by the method of K. S. Atwal, et al. and references contained therein (J. Med. Chem. (1998) 41, 217-275). The nitroethylene analog (Z = C-NO₂) can be synthesized by the method of F. Moimas, et al. (Synthesis 1985, 509-510) and references contained therein. The malononitrile analog (Z = C(CN)₂) may be synthesized by the method of S. Sasho, et al. (J. Med. Chem. 1993, 36, 572-579).

Guanidines (Z=NR^{1a}) can be synthesized by the methods outlined in Scheme 3. Compound 21 where Z=S can be methylated to yield the methylisothiurea 22. Displacement of the SMe group with amines yields substituted guanidines 23 (see H. King and I. M. Tonkin J. Chem. Soc. 1946, 1063 and references therein). Alternatively, reaction of thiourea 21 with amines in the presence of triethanolamine and "lac sulfur" which facilitates the removal of H₂S yields substituted guanidines 23 (K. Ramadas, Tet. Lett. 1996, 37, 5161 and references therein). Finally, the use of carbonimidoyldichloride 24, or 25 followed by sequential

displacements by amines yields the corresponding substituted guanidine 23 (S. Nagarajan, et al., Syn. Comm. 1992, 22, 1191-8 and references therein). In a similar manner, carbonimidoyldichlorides, $R^2-N=C(Cl)_2$ (not shown in Scheme 3) and $R^3-N=C(Cl)_2$ (not shown) can also be reacted sequentially with amines to yield di- and trisubstituted guanidine 23.

SCHEME 3

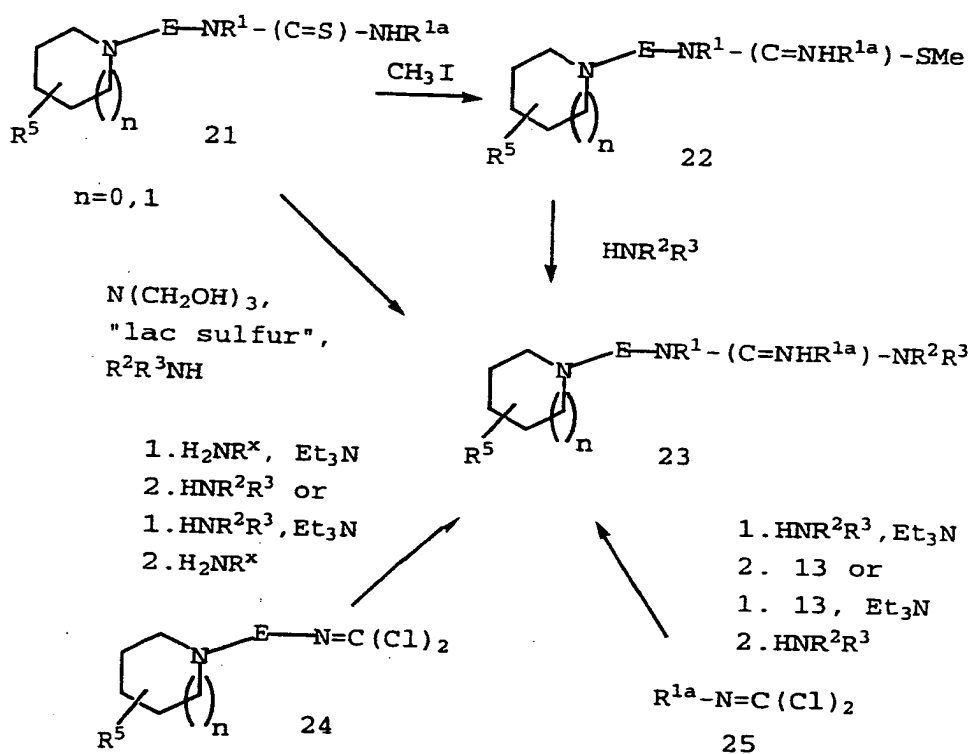

10

A method for introducing substituents in linkage E is that of A. Chesney et al. (Syn. Comm. 1990, 20 (20), 3167-3180) as shown in Scheme 4. Michael reaction of pyrrolidine or piperidine **1** with Michael acceptor **26** yields intermediate **27** which can undergo subsequent reactions in the same pot. For example, reduction yields alcohol **28** which can be elaborated to the amine **29** by standard procedures familiar to one skilled in the art. Some of

15

these include mesylation or tosylation followed by displacement with NaN_3 followed by reduction to yield amine 29. Another route as depicted in Scheme 4 involves reaction with diphenylphosphoryl azide followed by reduction of the azide to yield amine 29.

SCHEME 4

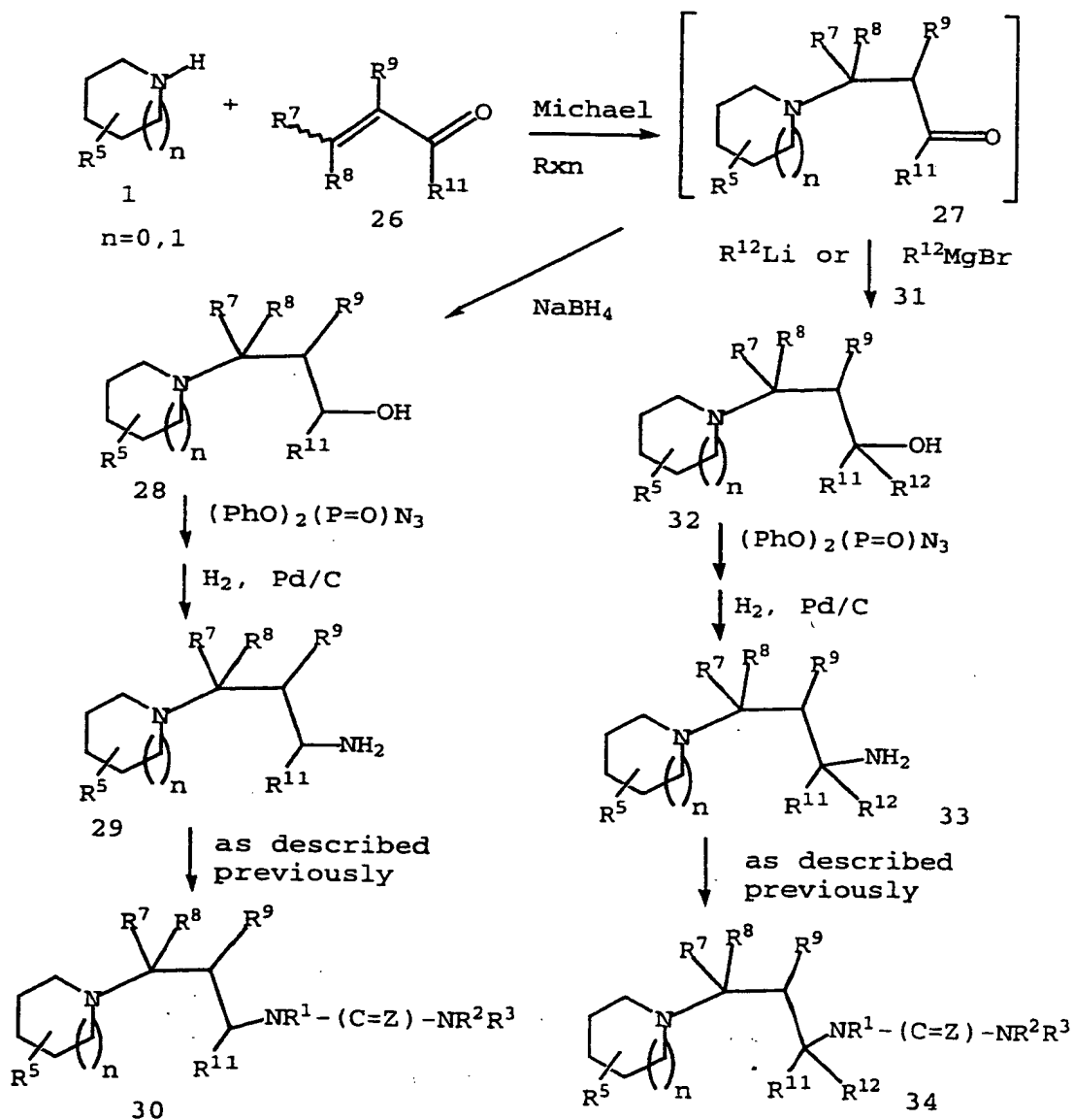

The mesylate or tosylate can also be displaced by other nucleophiles such as NH_3 , BOC_2N^- , potassium phthalimide, etc., with subsequent deprotection where necessary to yield amines 29. Finally, 29 can be converted to urea or thiourea 30 by procedures discussed for Scheme 1 or to the compounds of this invention by procedures previously discussed. Similarly, aldehyde 27 may be reacted with a lithium or a Grignard reagent 31 to yield alcohol adduct 32. This in turn can be converted to urea or thiourea 34 in the same way as discussed for the conversion of 28 to 30.

Scheme 5 shows that intermediate 36 can be extended via a Wittig reaction (A. Chesney, et al. Syn. Comm. 1990, 20 (20), 3167-3180) to yield 37. This adduct can be reduced catalytically to yield 38 or by other procedures familiar to one skilled in the art. Alkylation yields 39, followed by saponification and Curtius rearrangement (T. L. Capson and C. D. Poulter, Tet. Lett., (1984) 25, 3515-3518) followed by reduction of the benzyl protecting group yields amine 40 which can be elaborated further as was described earlier in Scheme 1 and elsewhere in this application to make the compounds of this invention. Dialkyl lithium cuprate, organocopper, or copper-catalyzed Grignard addition (for a review, see G. H. Posner, "An Introduction to Synthesis Using Organocopper Reagents", J. Wiley, New York, 1980; Organic Reactions, 19, 1 (1972)) to alpha,beta-unsaturated ester 37 yields 41 which can undergo subsequent transformations just discussed to yield amine 43 which can be elaborated further to the compounds of this invention as was described earlier. The intermediate enolate ion obtained upon cuprate addition to 37 can also be trapped by an electrophile to yield 42 (for a review, see R. J. K. Taylor, Synthesis 1985, 364). Likewise, another 2-carbon homologation is reported by A. Chesney et al. (ibid.) on intermediate 36 which involves reacting 36 with an enolate anion to yield aldol condensation product 42 where $\text{R}^{12}=\text{OH}$. The OH group can undergo synthetic transformations which

are familiar to one skilled in the art and which will be discussed in much detail later on in the application. Chiral auxiliaries can also be used to introduce stereo- and enantioselectivity in these aldol condensations,
5 procedures which are familiar to one skilled in the art.

SCHEME 5

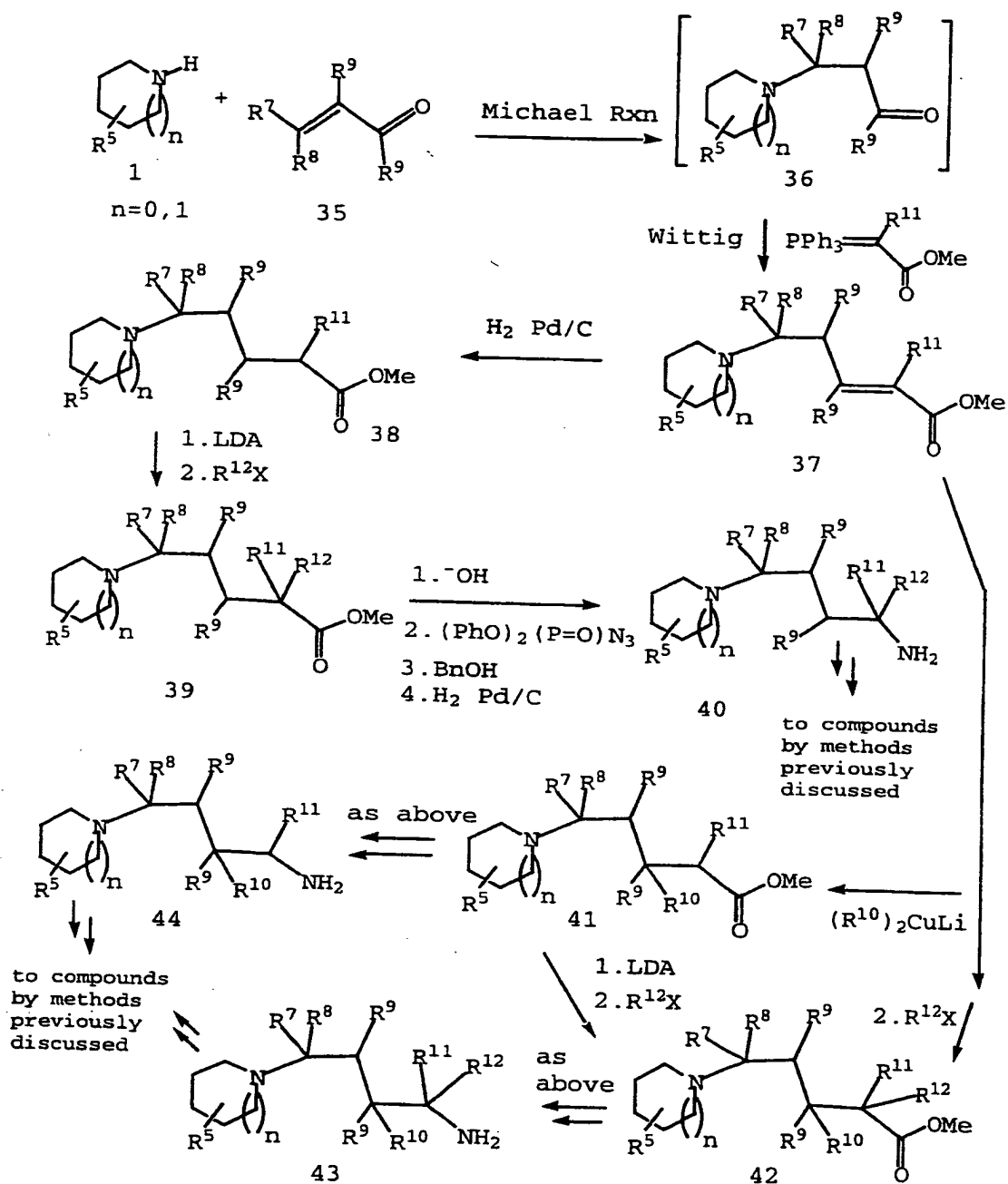

Examples of such methods are taught in D. A. Evans, et al.,
 J. Am. Chem. Soc. 1981, 103, 2127; D. A. Evans, J. Am.
 Chem. Soc. 1982, 104, 1737; D. A. Evans, J. Am. Chem. Soc.

1986, 108, 2476; D. A. Evans. et al., J. Am. Chem. Soc. 1986, 108, 6757; D. A. Evans, J. Am. Chem. Soc. 1986, 108, 6395; D. A. Evans, J. Am. Chem. Soc. 1985, 107, 4346; A. G. Myers, et al., J. Am. Chem. Soc. 1997, 119, 6496. One
5 can also perform an enantioselective alkylation on esters 38 or 41 with $R^{12}X$ where X is a leaving group as described in Scheme 1, provided the ester is first attached to a chiral auxiliary (see above references of Evans, Myers and Mauricio de L. Vanderlei, J. et al., Synth. Commun. 1998,
10 28, 3047).

One can also react alpha,beta-unsaturated ester 37 (Scheme 6) with Corey's dimethyloxosulfonium methylide (E.J. Corey and M. Chaykovsky, J. Am. Chem. Soc. 1965, 87, 1345) to form a cyclopropane which can undergo eventual
15 Curtius rearrangement and subsequent elaboration to the compounds of this invention wherein the carbon containing R^9R^{10} is tied up in a cyclopropane ring with the carbon containing $R^{11}R^{12}$. In addition, compound 48 can also undergo the analogous reactions just described to form
20 cyclopropylamine 50 which can be further elaborated into the compounds of this invention as described previously. Compound 48 may be synthesized by an alkylation reaction of pyrrolidine/piperidine 1 with bromide 47 in an inert solvent employing the conditions as described for the
25 alkylation of 2 onto 1 in Scheme 1.

Another way to synthesize the compounds in the scope of this application is shown in Scheme 7. Michael reaction of amine 1 with an acrylonitrile 51 (as described by I. Roufos in J. Med. Chem. 1996, 39, 1514-1520) followed by
30 Raney-Nickel hydrogenation yields amine 53 which can be elaborated to the compounds of this invention as previously described.

SCHEME 6

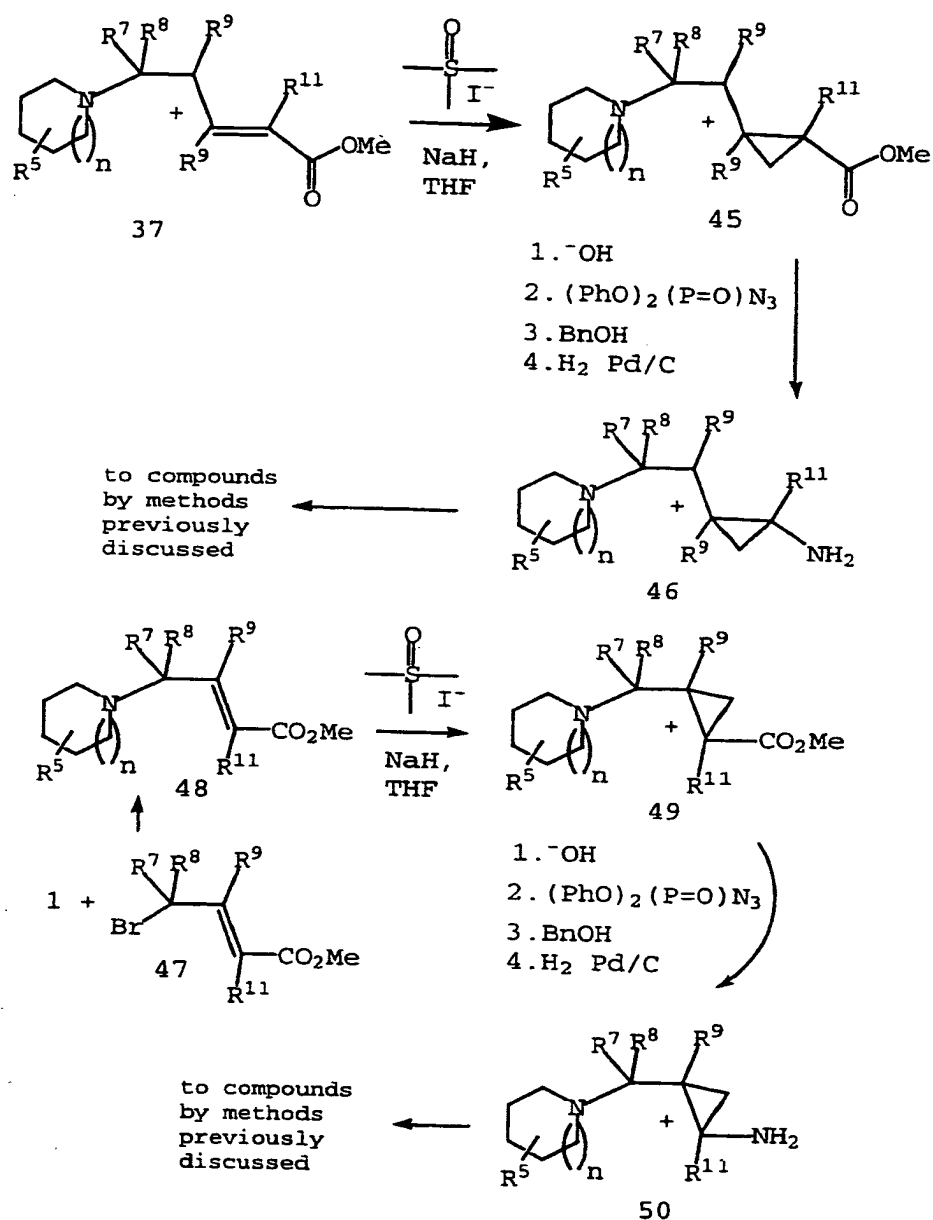

In Schemes 4, 5, and 6, we see that there is no gem-substitution on the alpha-carbon to the electron-withdrawing group of what used to be the Michael acceptor. In other words, in Scheme 4, there is no R¹⁰ gem to R⁹; in Scheme 5, there is no R¹⁰ gem to one of the R⁹s and in

Scheme 7 there is no R¹⁰ gem to R⁹. Gem-substitution can be introduced by reacting pyrrolidine or piperidine 1 with the epoxide of Michael acceptors 26, 35, and 51 to yield the corresponding alcohols (for amines reacting with epoxides of Michael acceptors, see Charvillon, F. B.; Amouroux, R.; Tet. Lett. 1996, 37, 5103-5106; Chong, J. M.; Sharpless, K. B.; J Org Chem 1985, 50, 1560). These alcohols eventually can be further elaborated into R¹⁰ by one skilled in the art, as, for example, by tosylation of the alcohol and cuprate displacement (Hanessian, S.; Thavonekham, B.; DeHoff, B.; J Org. Chem. 1989, 54, 5831), etc., and by other displacement reactions which will be discussed in great detail later on in this application.

SCHEME 7

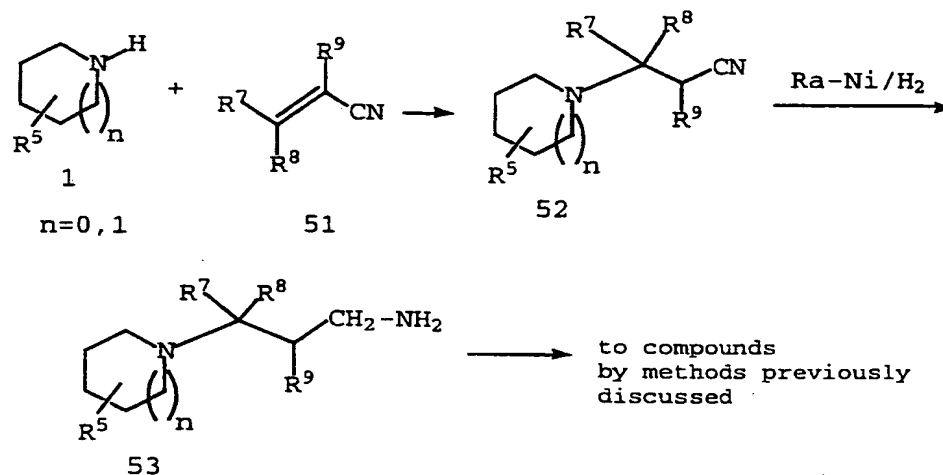

15

Further use of epoxides to synthesize compounds of this invention are shown in Scheme 8. Reaction of pyrrole or piperidine 1 with epoxide 54 yields protected amino-alcohol 55. This reaction works exceptionally well when R⁷ and R⁸ are H but is not limited thereto. The reaction is performed in an inert solvent at room temperature to the reflux temperature of the solvent. Protecting groups on the nitrogen atom of 54 include BOC and CBZ but are not limited thereto. The hydroxyl group can be optionally

protected by a variety of protecting groups familiar to one skilled in the art.

SCHEME 8

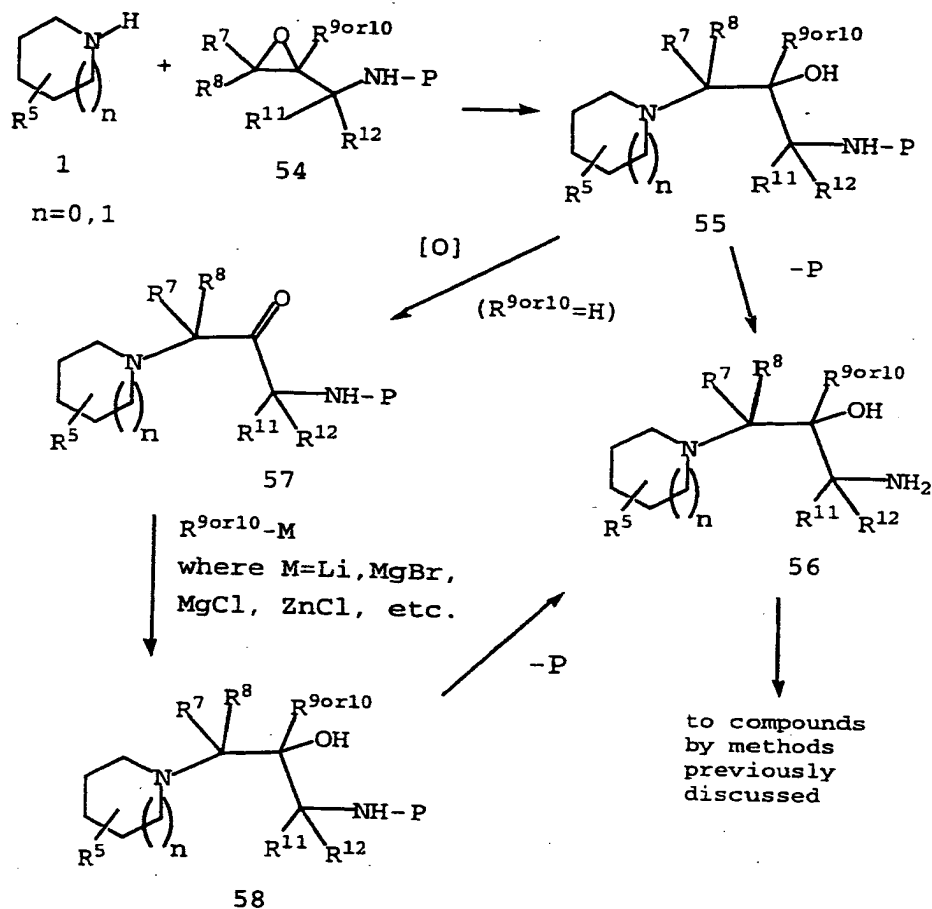

5

Deprotection of the nitrogen by methods familiar to one skilled in the art yields 56 which can be elaborated to the compounds of this invention by the procedures previously discussed. If $R^9=H$, then oxidation, for example, by using PCC (Corey E.J. and Suggs, J.W., Tet. Lett. 1975, 31, 2647-2650) or with the Dess-Martin periodinane (Dess, D.B. and Martin, J.C., J. Org. Chem. 1983, 48, 4155-4156) yields ketone 57 which may undergo nucleophilic 1,2-addition with organometallic reagents such as alkyl- or aryllithiums,

Grignards, or zinc reagents, with or without $CeCl_3$ (T. Imamoto, et al., Tet. Lett. 1985, 26, 4763-4766; T. Imamoto, et al., Tet. Lett. 1984, 25, 4233-4236) in aprotic solvents such as ether, dioxane, or THF to yield alcohol 58. The hydroxyl group can be optionally protected by a variety of protecting groups familiar to one skilled in the art. Deprotection of the nitrogen yields 56 which can be finally elaborated to the compounds of this invention as previously discussed. Epoxides disclosed by structure 54 may be synthesized enantio-selectively from amino acid starting materials by the methods of Dellaria, et al. J Med Chem 1987, 30 (11), 2137, and Luly, et al. J Org Chem 1987, 52 (8), 1487.

The carbonyl group of ketone 57 in Scheme 8 may undergo Wittig reactions followed by reduction of the double bond to yield alkyl, arylalkyl, heterocyclic-alkyl, cycloalkyl, cycloalkylalkyl, etc. substitution at that position, reactions that are familiar to one skilled in the art. Wittig reagents can also contain functional groups which after reduction of the double bond yield the following functionality: esters (Buddrus, J. Angew Chem., 1968, 80), nitriles (Cativiela, C. et al., Tetrahedron 1996, 52 (16), 5881-5888.), ketone (Stork, G. et al., J Am Chem Soc 1996, 118 (43), 10660-10661), aldehyde and methoxymethyl (Bertram, G. et al., Tetrahedron Lett 1996, 37 (44), 7955-7958.), gamma-butyrolactone Vidari, G. et al., Tetrahedron: Asymmetry 1996, 7 (10), 3009-3020.), carboxylic acids (Svoboda, J. et al., Collect Czech Chem Commun 1996, 61 (10), 1509-1519), ethers (Hamada, Y. et al., Tetrahedron Lett 1984, 25 (47), 5413), alcohols (after hydrogenation and deprotection--Schonauer, K.; Zbiral, E.; Tetrahedron Lett 1983, 24 (6), 573), amines (Marxer, A.; Leutert, T. Helv Chim Acta, 1978, 61) etc., all of which may further undergo transformations familiar to one skilled in the art to form a wide variety of functionality at this position.

Scheme 9 summarizes the displacement chemistry and subsequent elaborations that can be used to synthesize the R⁹ groups. In Scheme 9 we see that alcohol 55 or 58 may be tosylated, mesylated, triflated, or converted to a halogen
5 by methods familiar to one skilled in the art to produce compound 59. (Note that all of the following reactions in this paragraph can be also performed on the compounds, henceforth called carbon homologs of 55 or 58 where OH can be (CH₂)_rOH and it is also understood that these carbon
10 homologs may have substituents on the methylene groups as well). For example, a hydroxyl group may be converted to a bromide by CBr₄ and Ph₃P (Takano, S. Heterocycles 1991, 32, 1587). For other methods of converting an alcohol to a bromide or to a chloride or to an iodide see R.C. Larock, Comprehensive Organic Transformations, VCH Publishers, New
15 York, 1989, pp. 354-360. Compound 59 in turn may be displaced by a wide variety of nucleophiles as shown in Scheme 9 including but not limited to azide, cyano, malonate, cuprates, potassium thioacetate, thiols, amines,
20 etc., all nucleophilic displacement reactions being familiar to one skilled in the art. Displacement by nitrile yields a one-carbon homologation product. Nitrile 60 can be reduced with DIBAL to yield aldehyde 61. This aldehyde can undergo reduction to alcohol 62 with, for
25 example, NaBH₄ which in turn can undergo all of the S_N2 displacement reactions mentioned for alcohol 55 or 58. Alcohol 62 is a one carbon homolog of alcohol 55 or 58. Thus one can envision taking alcohol 62, converting it to a leaving group X as discussed above for compound 55 or 58,
30 and reacting it with NaCN or KCN to form a nitrile, subsequent DIBAL reduction to the aldehyde and subsequent NaBH₄ reduction to the alcohol resulting in a two carbon homologation product. This alcohol can undergo activation followed by the same S_N2 displacement reactions discussed
35 previously, ad infinitum, to result in 3,4,5...etc. carbon homologation products. Aldehyde 61 can also be reacted with a lithium or Grignard reagent to form an alcohol 61a

which can also undergo the above displacement reactions. Oxidation by methods familiar to one skilled in the art yields ketone 61b. Displacement by malonate yields malonic ester 63 which can be saponified and decarboxylated to yield carboxylic acid 64, a two carbon homologation product. Conversion to ester 65 (A. Hassner and V. Alexanian, Tet. Lett, 1978, 46, 4475-8) and reduction with LAH yields alcohol 68 which can undergo all of the displacement reactions discussed for alcohol 55 or 58.

Alcohols may be converted to the corresponding fluoride 70 by DAST (diethylaminosulfur trifluoride) (Middleton, W. J.; Bingham, E. M.; Org. Synth. 1988, VI, pg. 835). Sulfides 71 can be converted to the corresponding sulfoxides 72 (p=1) by sodium metaperiodate oxidation (N. J. Leonard, C. R. Johnson J. Org. Chem. 1962, 27, 282-4) and to sulfones 72 (p=2) by Oxone® (A. Castro, T.A. Spencer J. Org. Chem. 1992, 57, 3496-9). Sulfones 72 can be converted to the corresponding sulfonamides 73 by the method of H.-C. Huang, E. et al., Tet. Lett. (1994) 35, 7201-7204 which involves first, treatment with base followed by reaction with a trialkylborane yielding a sulfinic acid salt which can be reacted with hydroxylamine-O-sulfonic acid to yield a sulfonamide. Another route to sulfonamides involves reaction of amines with a sulfonyl chloride (G. Hilgetag and A. Martini, Preparative Organic Chemistry, New York: John Wiley and Sons, 1972, p.679). This sulfonyl chloride (not shown in Scheme 9) can be obtained from the corresponding sulfide (71 where R^{9d}=H in Scheme 9, the hydrolysis product after thioacetate displacement), disulfide, or isothiuronium salt by simply reacting with chlorine in water. The isothiuronium salt may be synthesized from the corresponding halide, mesylate or tosylate 59 via reaction with thiourea (for a discussion on the synthesis of sulfonyl chlorides see G. Hilgetag and A. Martini, *ibid.*, p. 670). Carboxylic acid 64 can be converted to amides 66 by standard coupling procedures or via an acid chloride by Schotten-Baumann chemistry or to a

Weinreb amide (66: $R^{9a}=\text{OMe}$, $R^{9a'}=\text{Me}$ in Scheme 9) (S. Nahm and S. M. Weinreb, Tet. Lett., 1981, 22, 3815-3818) which can undergo reduction to an aldehyde 67 ($R^{9b}=\text{H}$ in Scheme 9) with LAH (S. Nahm and S. M. Weinreb, *ibid.*) or reactions with Grignard reagents to form ketones 67 (S. Nahm and S. M. Weinreb, *ibid.*). The aldehyde 67 obtained from the Weinreb amide reduction can be reduced to the alcohol with NaBH_4 . The aldehyde or ketone 67 (or 61 or 61b for that matter) can undergo Wittig reactions as discussed previously followed by optional catalytic hydrogenation of the olefin. This Wittig sequence is one method for synthesizing the carbocyclic and heterocyclic substituted systems at R^9 employing the appropriate carbocyclic or heterocyclic Wittig (or Horner-Emmons) reagents. Of course, the Wittig reaction may also be used to synthesize alkenes at R^9 and other functionality as well. Ester 65 can also form amides 66 by the method of Weinreb (A. Basha, M. Lipton, and S.M. Weinreb, Tet. Lett. 1977, 48, 4171-74) (J. I. Levin, E. Turos, S. M. Weinreb, Syn. Comm. 1982, 12, 989-993). Alcohol 68 can be converted to ether 69 by procedures familiar to one skilled in the art, for example, NaH , followed by an alkyl iodide or by Mitsunobu chemistry (Mitsunobu, O. Synthesis, 1981, 1-28). Alcohol 55 or 58, 62, or 68, can be acylated by procedures familiar to one skilled in the art, for example, by Schotten-Baumann conditions with an acid chloride or by an anhydride with a base such as pyridine to yield 78. Halide, mesylate, tosylate or triflate 59 can undergo displacement with azide followed by reduction to yield amine 74 a procedure familiar to one skilled in the art. This amine can undergo optional reductive amination and acylation to yield 75 or reaction with ethyl formate (usually refluxing ethyl formate) to yield formamide 75. Amine 74 can again undergo optional reductive amination followed by reaction with a sulfonyl chloride to yield 76, for example under Schotten-Baumann conditions as discussed previously. This same sequence may be employed for amine 60a, the reduction

product of nitrile 60. Tosylate 59 can undergo displacement with cuprates to yield 77 (Hanessian, S.; Thavonekham, B.; DeHoff, B.; J Org. Chem. 1989, 54, 5831). Aldehyde 61 or its homologous extensions can be reacted
5 with a carbon anion of an aryl (phenyl, naphthalene, etc.) or heterocyclic group to yield an aryl alcohol or a heterocyclic alcohol. If necessary, CeCl₃ may be added (T. Imamoto, et al., Tet. Lett. 1985, 26, 4763-4766; T. Imamoto, et al., Tet. Lett. 1984, 25, 4233-4236). This
10 alcohol may be reduced with Et₃SiH and TFA (J. Org. Chem. 1969, 34, 4; J. Org. Chem. 1987, 52, 2226) (see discussion of aryl and heterocyclic anions for Schemes 20-22). These aryl and heterocyclic anions may also be alkylated by 59 (or its carbon homolog) to yield compounds where R⁹
15 contains an aryl or heterocyclic group. Compound 59 or its carbon homologs may be alkylated by an alkyne anion to produce alkynes at R⁹ (see R.C. Larock, Comprehensive Organic Transformations, New York, 1989, VCH Publishers, p 297). In addition, carboxaldehyde 61 or its carbon
20 homologs can undergo 1,2-addition by an alkyne anion (Johnson, A.W. The Chemistry of Acetylenic Compounds. V. 1. "Acetylenic Alcohols," Edward Arnold and Co., London (1946)). Nitro groups can be introduced by displacing bromide 59 (or its carbon homologs) with sodium nitrite in
25 DMF (J.K. Stille and E.D. Vessel J. Org. Chem. 1960, 25, 478-490) or by the action of silver nitrite on iodide 59 or its carbon homologs (Org. Syntheses 34, 37-39).

SCHEME 9

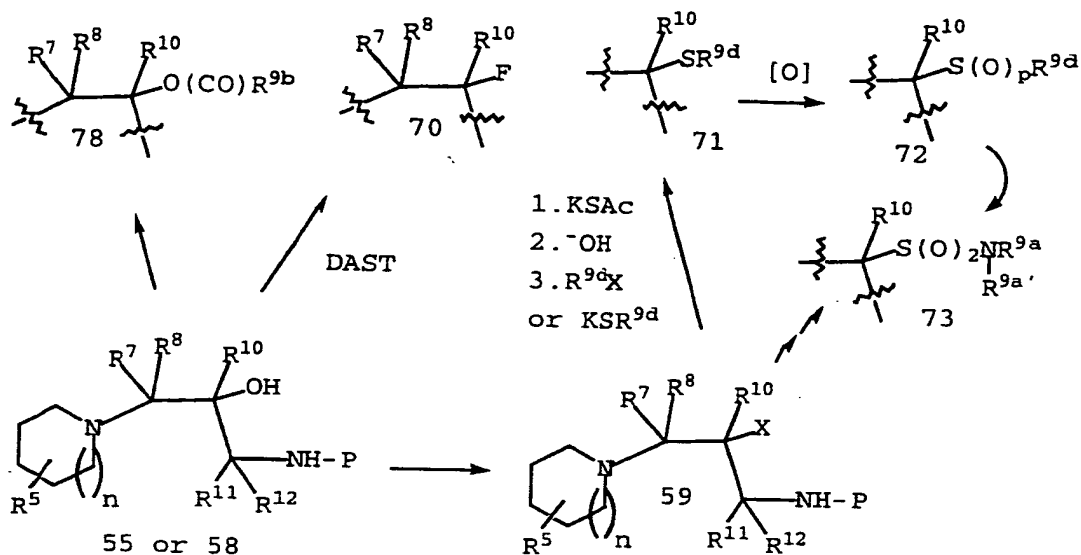

If an anion is made of the pyrrolidine/piperidine 1 with LDA or *n*-BuLi, etc., then that anion in a suitable nonhydroxylic solvent such as THF, ether, dioxane, etc., can react in a Michael-type fashion (1,4-addition) with an alpha,beta-unsaturated ester to yield an intermediate enolate which can be quenched with an electrophile (R⁹X) (where X is as described in Scheme 1) (Uyehara, T.; Asao, N.; Yamamoto, Y.; J Chem Soc, Chem Commun 1987, 1410) as shown in Scheme 10.

SCHEME 9 (con't)

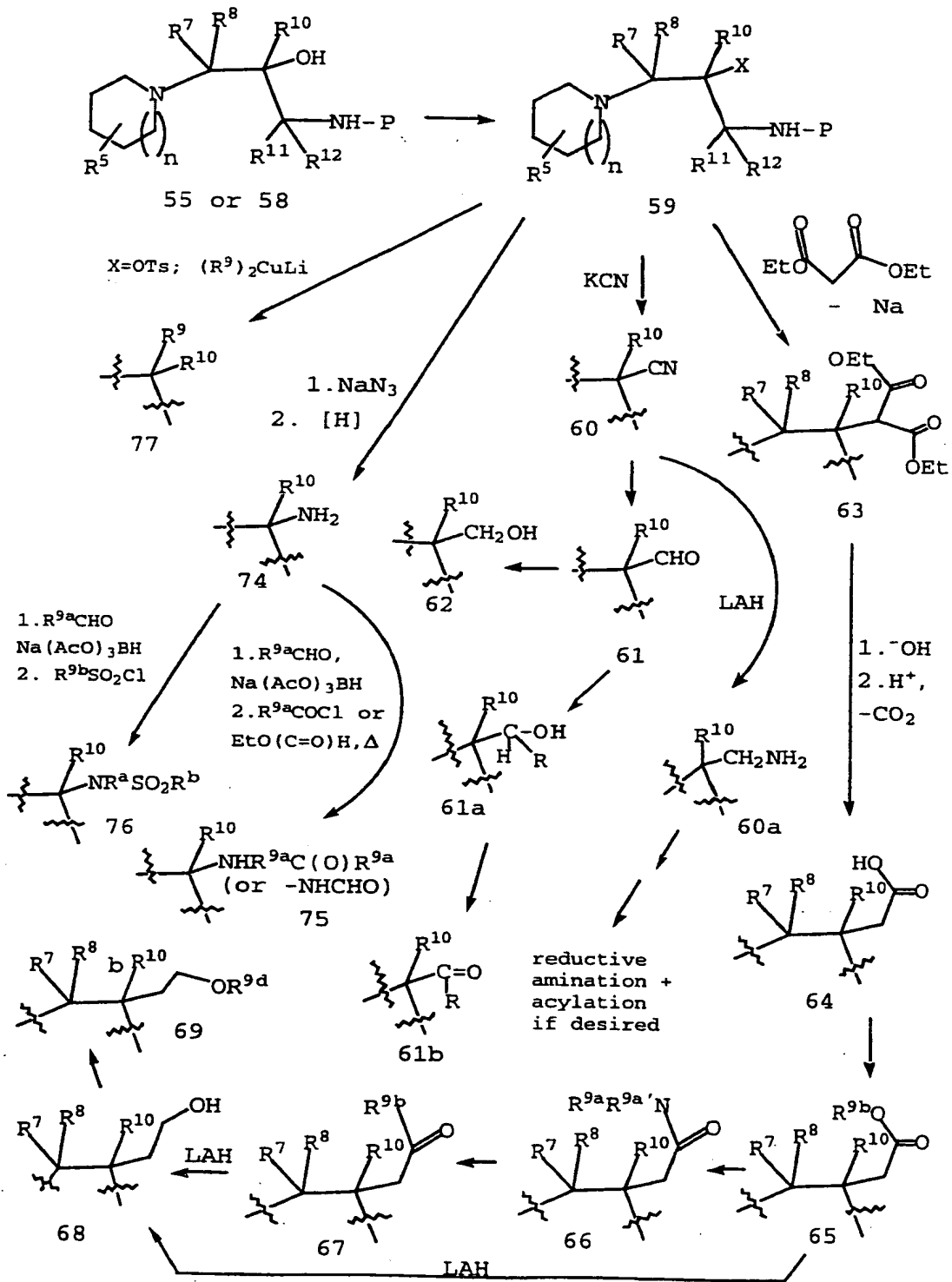

It is to be understood that R⁹ is either in its final form or in a suitable protected precursor form. This
5 electrophile can be a carbon-based electrophile, some examples being formaldehyde to introduce a CH₂OH group, an aldehyde or a ketone which also introduces a one-carbon homologated alcohol, ethylene oxide (or other epoxides) which introduces a -CH₂CH₂OH group (a two-carbon homologated
10 alcohol), an alkyl halide, etc., all of which can be later elaborated into R⁹. It can also be an oxygen-based electrophile such as MCPBA, Davis' reagent (Davis, F. A.; Haque, M. S.; J Org Chem 1986, 51 (21), 4083; Davis, F. A.; Vishwaskarma, L. C.; Billmers, J. M.; Finn, J.; J Org Chem
15 1984, 49, 3241) or MoO₅ (Martin, T. et al., J Org Chem 1996, 61 (18), 6450-6453) which introduces an OH group. These OH groups can undergo the displacement reactions discussed previously in Scheme 9 or protected by suitable protecting groups and deprotected at a later stage when the
20 displacement reactions described in Scheme 9 can be performed. In addition, these OH groups can also undergo displacement reactions with heterocycles as described for Schemes 19-22 to introduce N- or C-substituted heterocycles at this position. Ester 80 can be converted into its
25 Weinreb amide 82 (S. Nahm and S. M. Weinreb, Tet. Lett., 1981, 22, 3815-3818) or Weinreb amide 82 can be synthesized via Michael-type addition of 1 to alpha,beta-unsaturated Weinreb amide 83. Subsequent reaction with a Grignard reagent forms ketone 85. This ketone can also be
30 synthesized in one step directly from 1 and alpha,beta-unsaturated ketone 84 using the same procedure. This ketone may be reduced with LAH, NaBH₄ or other reducing agents to form alcohol 86. Or else, ketone 85 can be reacted with an organolithium or Grignard reagents to form
35 tertiary alcohol 87. Or else, ester 80 can be directly reduced with LiBH₄ or LAH to yield primary alcohol 88.

SCHEME 10

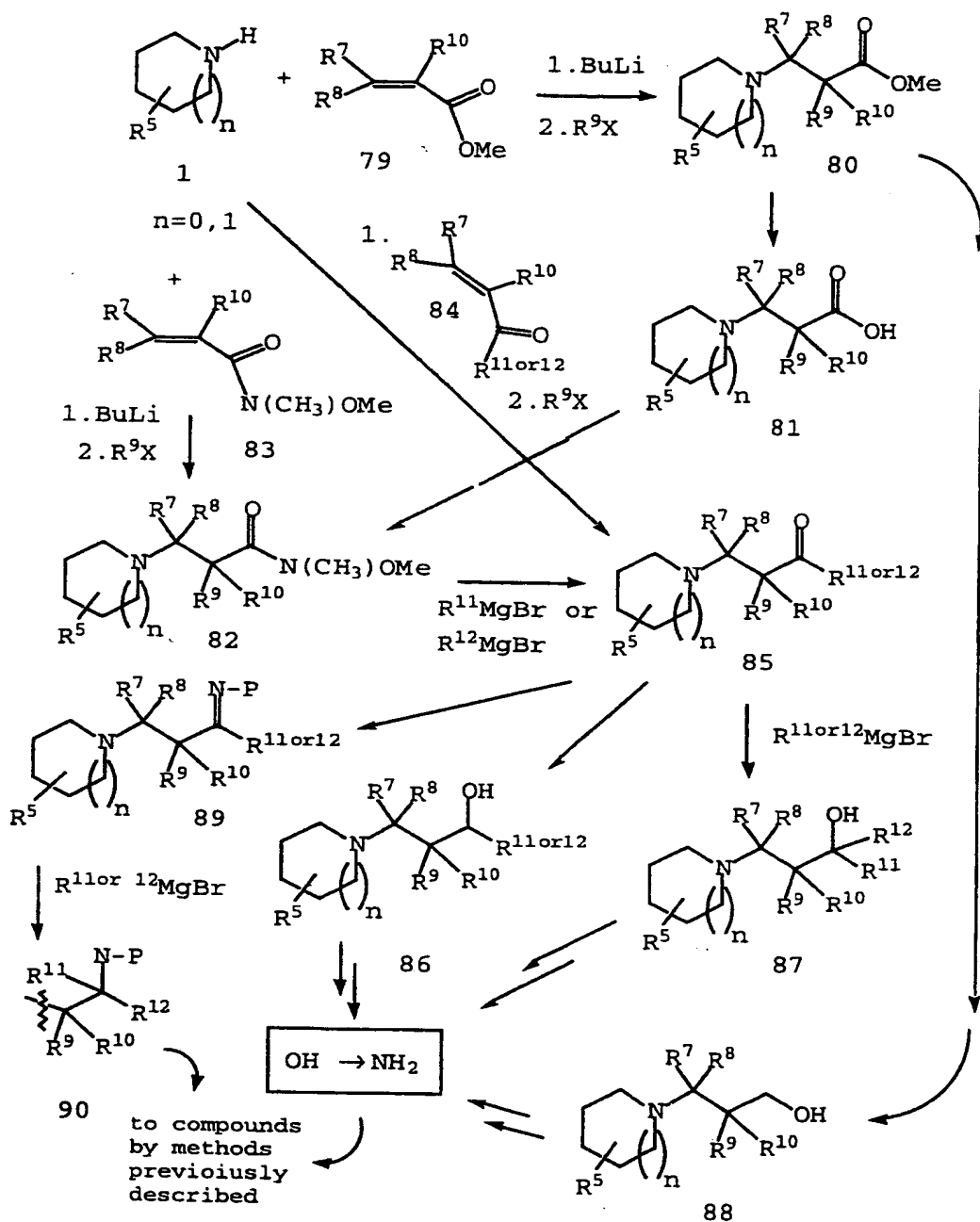

Alcohols 86, 87, and 88 can all be tosylated, mesylated, triflated, or converted to a halogen by methods discussed previously and displaced with an amine nucleophile such as azide, diphenylphosphoryl azide (with or without DEAD and

Ph₃P), phthalimide, etc. as discussed previously (and which are familiar to one skilled in the art) and after reduction (azide) or deprotection with hydrazine (phthalimide), for example, yield the corresponding amines. These can then be elaborated into the compounds of this invention as discussed previously. Ketone 85 can also be converted into imine 89 which can be reacted with a Grignard reagent or lithium reagent, etc., to form a protected amine 90 which can be deprotected and elaborated into the compounds of this invention as discussed previously. Some protecting groups include benzyl and substituted benzyl which can be removed by hydrogenation, and cyanoethyl, which can be removed with aqueous base, etc. It is to be understood that R⁷⁻¹² in Scheme 10 can be in their final form or in precursor form which can be elaborated into final form by procedures familiar to one skilled in the art.

Magnesium amides of amines have been used to add in a Michael-type manner to alpha,beta-unsaturated esters where the substituents at the beta position of the unsaturated ester are tied together to form a cyclopentane ring (for example, compound 79 where R⁷ and R⁸ are taken together to be -(CH₂)₄-) (Kobayashi, K. et al., Bull Chem Soc Jpn, 1997, 70 (7), 1697-1699). Thus reaction of pyrrolidine or piperidine 1 with cycloalkylidene esters 79 as in Scheme 10 yields esters 80 where R⁷ and R⁸ are taken together to form a cycloalkyl ring. Subsequent elaboration yields compounds of this invention where R⁷ and R⁸ are taken together to form a cycloalkyl ring.

Compounds of structure 95a may also be synthesized from epoxyalcohols which are shown in Scheme 11. Allylic alcohol 91 can be epoxidized either stereoselectively using VO(acac)₂ catalyst (for a review, see Evans: Chem. Rev. 1993, 93, 1307) or enantioselectively (Sharpless: J. Am. Chem. Soc. 1987, 109, 5765) to epoxyalcohol 92. S_N2 displacement of the alcohol using zinc azide and triphenylphosphine (Yoshida, A. J. Org. Chem. 57, 1992, 1321-1322) or diphenylphosphoryl azide, DEAD, and

triphenylphosphine (Saito, A. et al., Tet. Lett. 1997, 38 (22), 3955-3958) yields azidoalcohol 93. Hydrogenation over a Pd catalyst yields aminoalcohol 94. This can be protected in situ or in a subsequent step with BOC₂O to put
5 on a BOC protecting group, or with CBZ-Cl and base to put on a CBZ-group or other protecting groups. Alternatively, the amino group can be reacted with an isocyanate, an isothiocyanate, a carbamoyl chloride, or any reagent
10 1 to form the compounds of this invention.

SCHEME 11

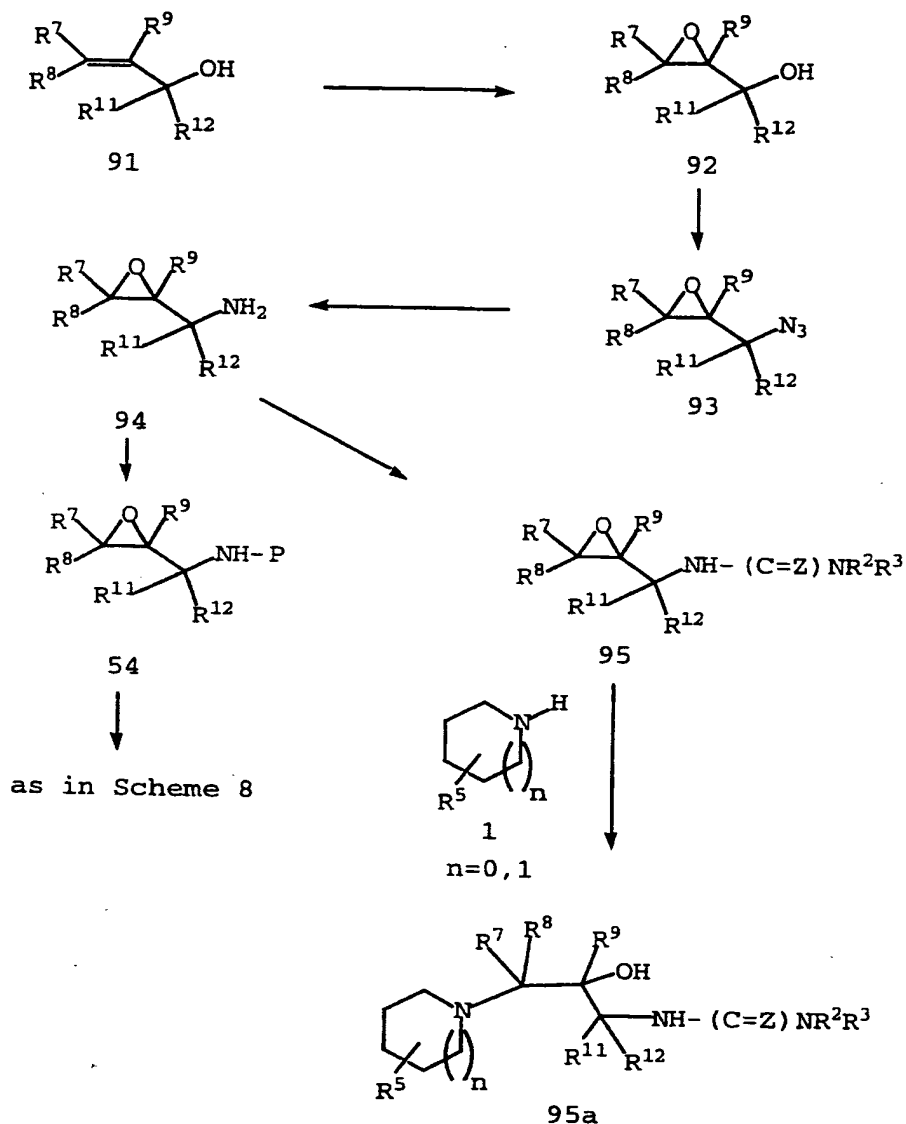

Sometimes amine **1** might have to be activated with Lewis acids in order to open the epoxide ring (Fujiwara, M.; Imada, M.; Baba, A.; Matsuda, H.; Tetrahedron Lett 1989, 30, 739; Caron, M.; Sharpless, K. B.; J Org Chem 1985, 50, 1557) or **1** has to be deprotonated and used as a metal amide, for example the lithium amide (Gorzynski-Smith, J.; Synthesis 1984 (8), 629) or MgBr amide (Carre, M. C.;

Houmounou, J. P.; Caubere, P.; Tetrahedron Lett 1985, 26, 3107) or aluminum amide (Overman, L. E.; Flippin, L. A.; Tetrahedron Lett 1981, 22, 195).

The quaternary salts (where R⁴ is present as a
5 substituent) of pyrrolidines and piperidines can be
synthesized by simply reacting the amine with an alkylating
agent, such as methyl iodide, methyl bromide, ethyl iodide,
ethyl bromide, ethyl or methyl bromoacetate,
10 bromoacetonitrile, allyl iodide, allylbromide, benzyl
bromide, etc. in a suitable solvent such as THF, DMF, DMSO,
etc. at room temperature to the reflux temperature of the
solvent. Spiroquaternary salts can be synthesized in a
similar manner, the only difference being that the
15 alkylating agent is located intramolecularly as shown in
Scheme 12. It is understood by one skilled in the art that
functional groups might not be in their final form to
permit cyclization to the quaternary ammonium salt and
might have to be in precursor form or in protected form to
be elaborated to their final form at a later stage. For
20 example, the NR¹(C=Z)NR²R³ group on the rightmost phenyl
ring of compound 104 might exist as a nitro group precursor
for ease of manipulation during quaternary salt formation.
Subsequent reduction and NR¹(C=Z)NR²R³ group formation
yields product 105. The leaving groups represented by X in
25 Scheme 12 may equal those represented in Scheme 1, but are
not limited thereto. N-oxides of pyrrolidines and
piperidines can be made by the procedure of L. W. Deady
(Syn. Comm. 1977, 7, 509-514). This simply entails
reacting the pyrrolidine or piperidine with MCPBA, for
30 example, in an inert solvent such as methylene chloride.

SCHEME 12

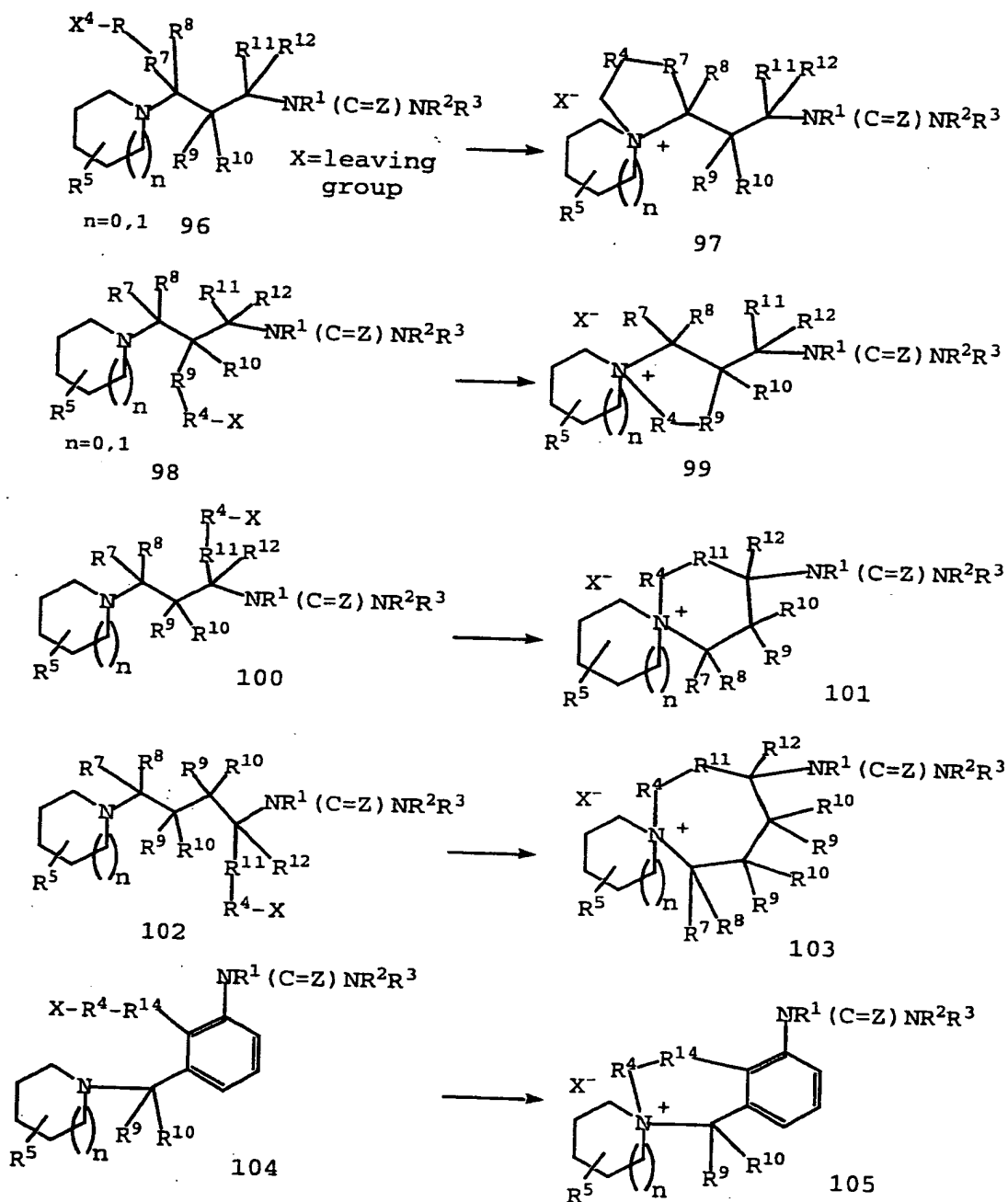

Multisubstituted pyrrolidines and piperidines may be synthesized by the methods outlined in Scheme 13.

5 Monoalkylation of 106 via an enolate using LDA or potassium

hexamethyldisilazane, or converting 106 first to an enamine, or by using other bases, all of which can be done in THF, ether, dioxane, benzene, or an appropriate non-hydroxylic solvent at $-78\text{ }^{\circ}\text{C}$ to room temperature with an alkylating agent such as methyl iodide, benzyl bromide, etc. where X is as defined in Scheme 1, yields product 107. This product can subsequently undergo alkylation again under thermodynamic or kinetic conditions and afterwards, if need be, can undergo two more alkylations to produce tri- and tetrasubstituted analogs of 107. The thermodynamic or kinetic conditions yield regioselectively alkylated products (for a discussion on thermodynamic vs. kinetic alkylations see H. House Modern Synthetic Reactions, W. A. Benjamin, Inc. (Menlo Park, CA: 1972) chapter 9).

SCHEME 13

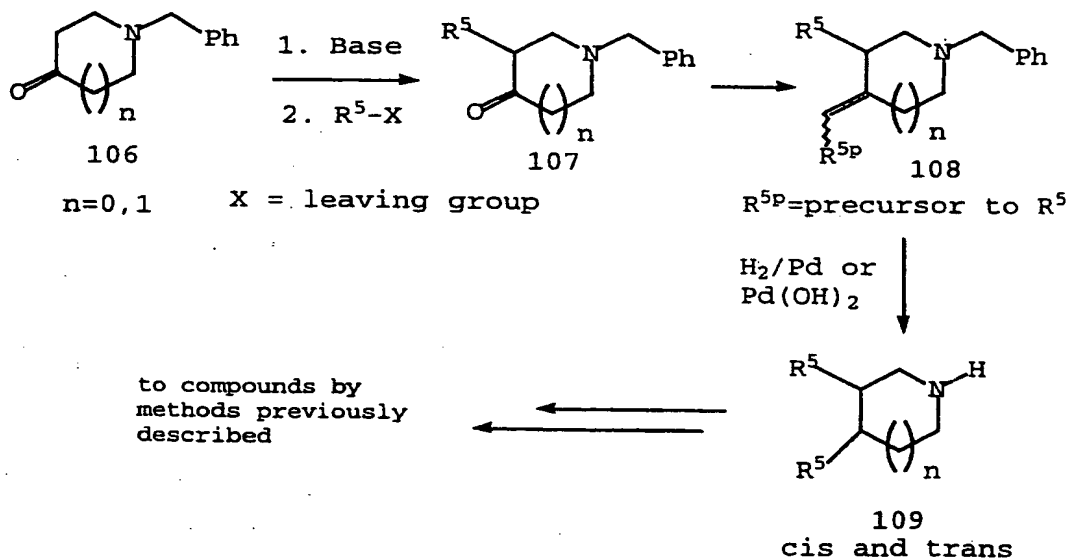

SCHEME 14

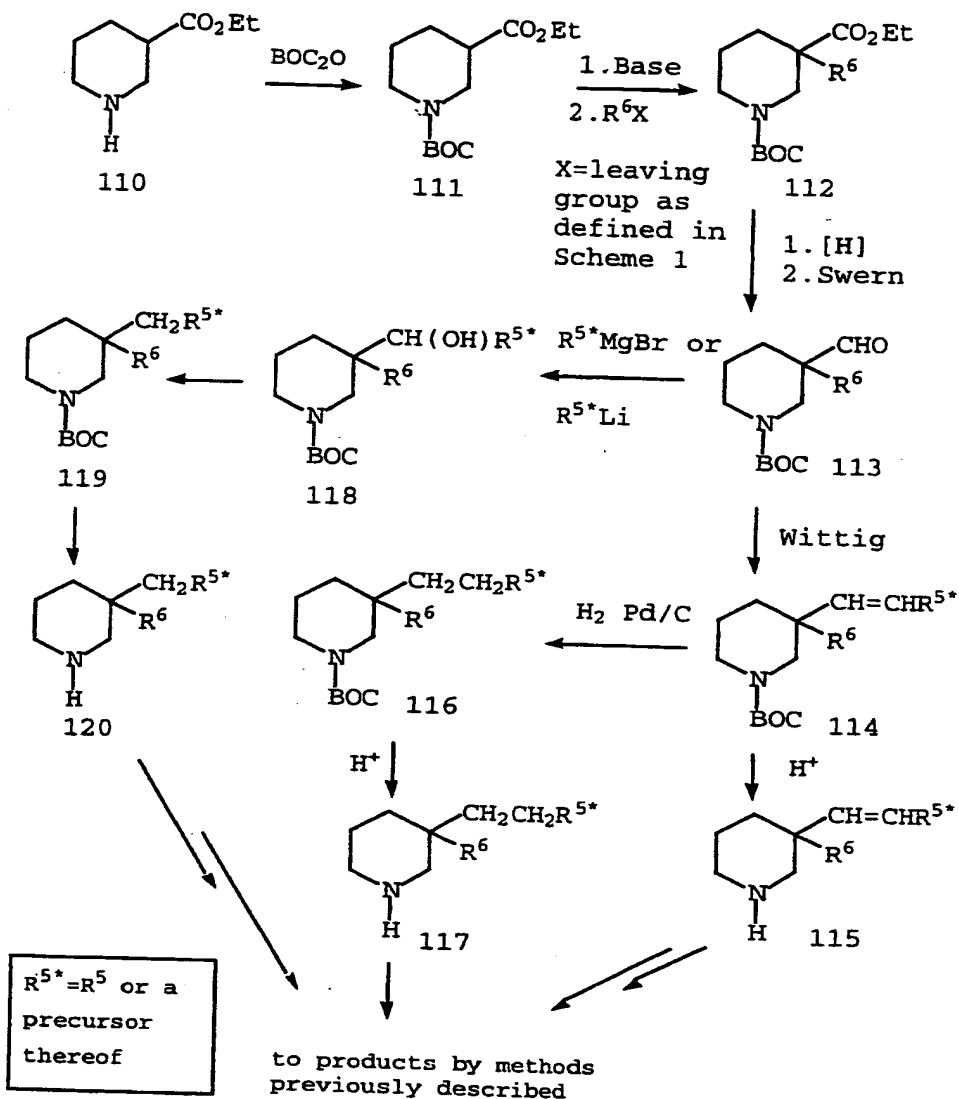

Subsequent Wittig olefination yields compound 108. Hydrogenation (asymmetric hydrogenation is an option here: Parshall, G.W. Homogeneous Catalysis, John Wiley and Sons, New York: 1980, pp. 43-45; Collman, J.P., Hegedus, L.S. Principles and Applications of Organotransition Metal Chemistry, University Science Books, Mill Valley, CA, 1980, pp. 341-348) yields pyrrolidine or piperidine 109 which can

be resolved into its relative and/or absolute isomers at this stage or later on in the synthesis either by crystallization, chromatographic techniques, or other methods familiar to one skilled in the art. The amine 109 5 an then be elaborated into the compounds of this invention by methods discussed previously (Scheme 1). The carbonyl-containing intermediate 107 in Scheme 13 can also be reduced to the methylene analog via a Wolff-Kishner reduction and modifications thereof, or by other methods 10 familiar to one skilled in the art. The carbonyl group can also be reduced to an OH group, which can undergo all of the reactions described in Scheme 9 to synthesize the R⁶ groups. This piperidine or pyrrolidine can be deprotected and elaborated to the compounds of this invention by 15 methods discussed earlier. Thus, mono-, di-, tri-, or tetraalkylated carbonyl-containing pyrrolidines or piperidines can be synthesized, which in turn can be reduced to the corresponding -CH₂- analogs employing the Wolff-Kishner reduction or other methods.

20 Another method for synthesizing gem-substituted pyrrolidines and piperidines is shown in Scheme 14. It is understood by one skilled in the art that some of the steps in this scheme can be rearranged. It is also understood that gem-disubstitution is only shown at only one position 25 on the piperidine ring and that similar transformations may be performed on other carbon atoms as well, both for piperidine and pyrrolidine. Thus, 3-carboethoxypiperidine 110 may be BOC-protected and alkylated employing a base such as LDA, KHMDS, LHMDS, etc., in THF, ether, dioxane, 30 etc. at -78 °C to room temperature, and an alkylating agent R⁶X where X is a halide (halide = Cl, Br, I), mesylate, tosylate or triflate, to yield 112. Reduction using DIBAL, for example, and if necessary followed by oxidation such as a Swern oxidation (S. L. Huang, K. Omura, D. Swern J. Org. 35 Chem. 1976, 41, 3329-32) yields aldehyde 113. Wittig olefination (114) followed by deprotection yields 115 which may be elaborated as described previously into the

compounds of this invention. Reduction of the Wittig adduct 114 yields 116 which may be deprotected to yield 117 which may be in turn elaborated as described previously into the compounds of this invention. Reaction of
5 aldehyde 113 with an alkyllithium or Grignard reagent yields alcohol 118 which may be reduced catalytically or with Et₃SiH/TFA (J. Org. Chem. 1969, 34, 4; J. Org. Chem. 1987, 52, 2226) if R^{5*} (R^{5*} = R⁵ or a precursor thereof) is aromatic to yield 119. If R^{5*} is not aromatic, then the OH
10 may be reduced by the method of Barton (Barton, D. H. R.; Jaszberenyi, J. C. Tet. Lett. 1989, 30, 2619 and other references therein). Once tosylated, the alcohol can also be displaced with dialkyllithium cuprates (not shown) (Hanessian, S.; Thavonekham, B.; DeHoff, B.; J Org. Chem. 1989, 54, 5831). Deprotection if necessary yields 120
15 which may be elaborated as described previously into the compounds of this invention.

SCHEME 15

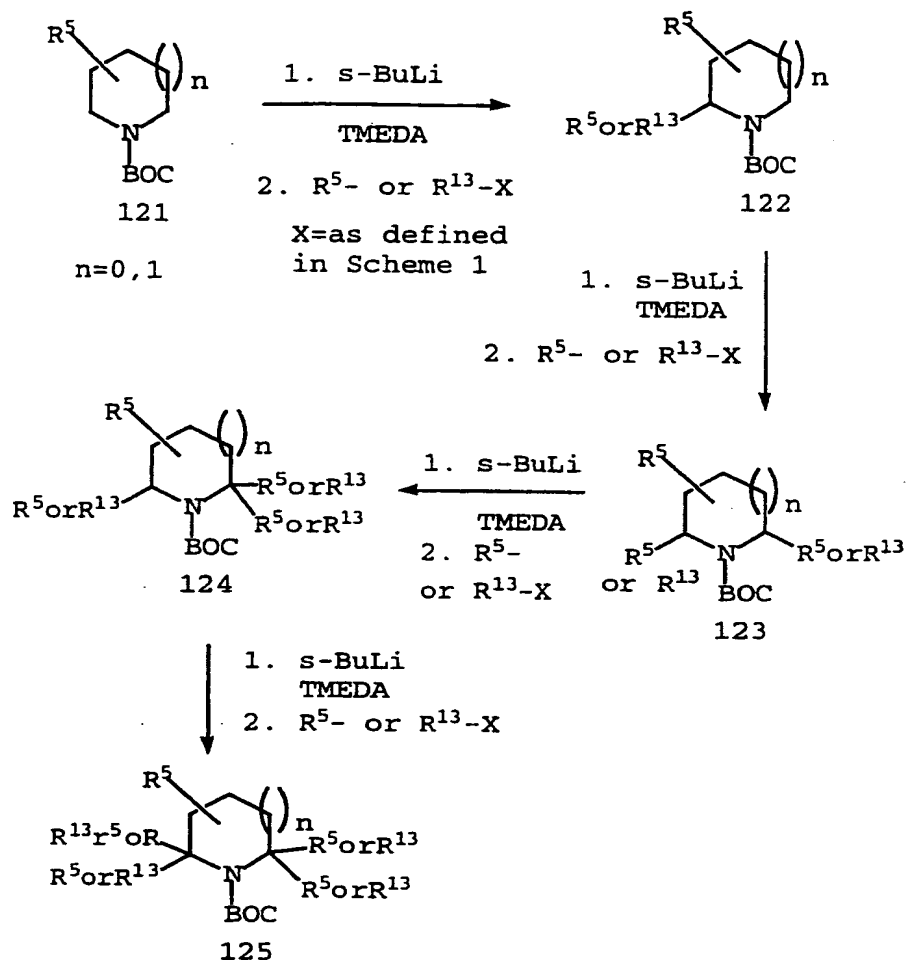

A method for the alkylation of alkyl groups, arylalkyl groups, allylic groups, propargylic groups, etc., and a variety of other electrophiles onto the pyrrolidinyl and/or piperidinyl alpha-carbons (alpha to the ring nitrogen atom) is represented by the work of Peter Beak, et al. as shown in Scheme 15. It is understood by one skilled in the art that the R⁵ and R¹³ groups are either in their precursor, protected, or final form. Only one R⁵ group is shown to be substituted on piperidine/pyrrolidine 121. However it is understood by one skilled in the art that additional functionality may be present on the ring in either

precursor, protected, or final form. Thus lithiation with an alkylolithium reagent such as n-BuLi or s-BuLi as shown, followed by quenching with an electrophilic species such as R⁵X or R¹³X where X is as defined in Scheme 1 and R⁵ and R¹³ are in their precursor, protected, or final form, yields monoalkylated piperidine/pyrrolidine 122. This alkylation may occur either stereoselectively (P. Beak and W.K. Lee J. Org. Chem. 1990, 55, 2578-2580) or enantioselectively if sparteine is included as a source of chirality (P. Beak, et al., J. Am. Chem. Soc. 1994, 116, 3231-3239). The alkylation process may be repeated up to three more times as shown in Scheme 15 to result in di-, tri-, and tetrasubstitution at the alpha-positions.

Compounds where R⁹ and R¹⁰ form a cyclic 3,4,5,6, or 7-membered ring can be synthesized by the methods disclosed in Scheme 16. These same methods may also be used to synthesize gem-disubstituted compounds in which R⁹ can be different from R¹⁰ by step-wise alkylation of the malonate derivative. Of course, this scheme may be used to synthesize compounds where R¹⁰=H also. For example, a cyclohexyl-fused malonate may be synthesized by Michael addition and alkylation of I(CH₂)₄CH=CCO₂Me with dimethyl malonate employing NaH/DMF (Desmaele, D.; Louvet, J.-M.; Tet Lett 1994, 35 (16), 2549-2552) or by a double Michael addition (Reddy, D. B., et al., Org. Prep. Proced. Int. 24 (1992) 1, 21 -26) (Downes, A. M.; Gill, N. S.; Lions, F.; J Am Chem or by an alkylation followed by a second intramolecular alkylation employing an iodoaldehyde (Suami, T.; Tadano, K.; Kameda, Y.; Iimura, Y.; Chem Lett 1984, 1919), or by an alkylation followed by a second intramolecular alkylation employing an alkyl dihalide (Kohnz, H.; Dull, B.; Mullen, K.; Angew Chem 1989, 101 (10), 1375), etc.

SCHEME 16

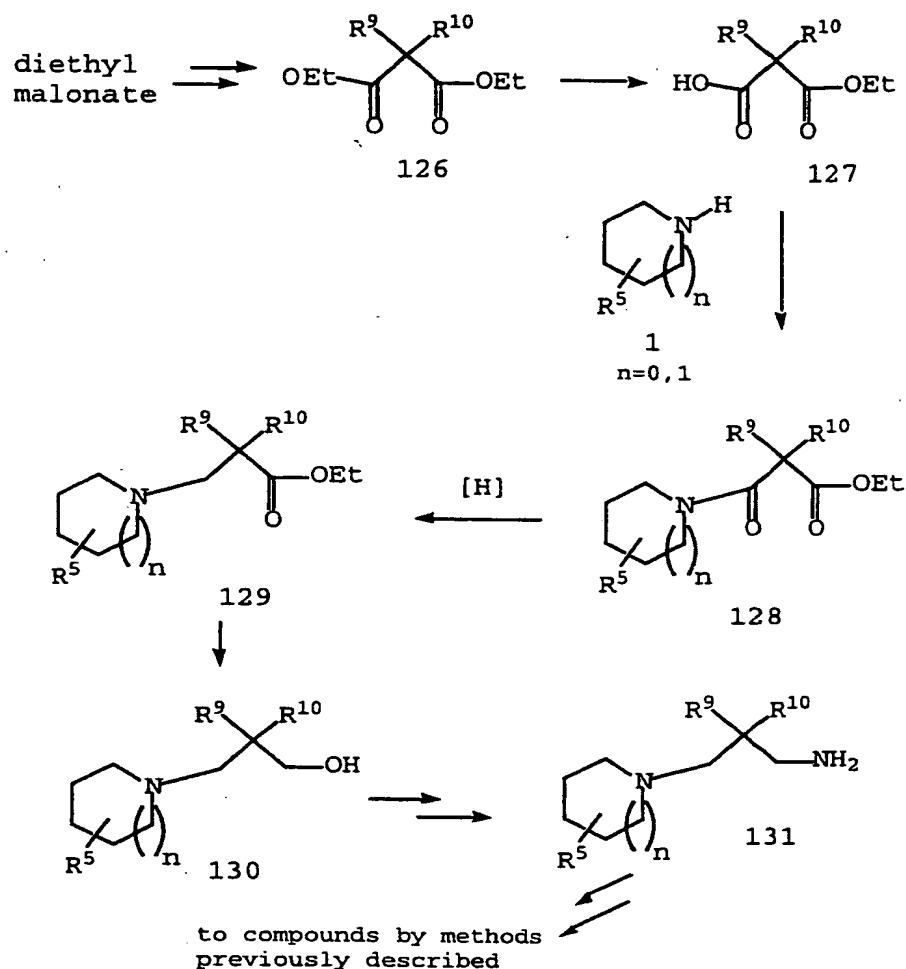

Subsequent monosaponification (Pallai, P.V., Richman, S., Struthers, R.S., Goodman, M. Int. J. Peptide Protein Res. 1983, 21, 84-92; M. Goodman Int. J. Peptide Protein Res. 1983, 17, 72-88), standard coupling with pyrrolidine/piperidine 1 yields 128. Reduction with borane yields 129 followed by reduction with LAH yields 130 which can be then converted to amine 131 and then to the compounds of this invention by procedures as discussed previously. Ester 129 can also be converted to a Weinreb amide and elaborated to the compounds of this invention as described in Scheme 10 for ester 80 which would introduce substituents R^{11} and R^{12} .

Scheme 17 describes another method for the synthesis of compounds where R⁹ and R¹⁰ are taken together to form cycloalkyl groups. Aminoalcohols 132 are found in the literature (CAS Registry Nos. for n = 0,1,2,3, respectively: 45434-02-4; 2041-56-7, 2239-31-8, 2041-57-8). They can easily be protected, as with a BOC group (or CBZ, or any other compatible protecting group) by known procedures familiar to one skilled in the art to yield alcohols 133. The alcohols can then be activated either by conversion to a halide or to a mesylate, tosylate or triflate by methods familiar to one skilled in the art and as discussed previously, and then alkylated with pyrrolidine/piperidine 1 by the conditions described in Scheme 1 to yield 135. Subsequent deprotection yields amine 136 which can be elaborated to the compounds of this invention as described previously. Of course, alcohol 133 can be oxidized to the aldehyde and then reacted with R⁷or⁸MgBr or R⁷or⁸Li with or without CeCl₃ to yield the corresponding alcohol 133 where instead of -CH₂OH, we would have -CHR⁷or⁸OH. This oxidation-1,2-addition sequence may be repeated to yield a tertiary alcohol. The alcohol may then be tosylated, mesylated, triflated, or converted to Cl, Br, or I by procedures familiar to one skilled in the art to yield 134 and then displaced with pyrrolidine/piperidine 1 to yield 135. Subsequent deprotection yields 136 which may undergo elaboration to the compounds of this invention as discussed previously.

SCHEME 17

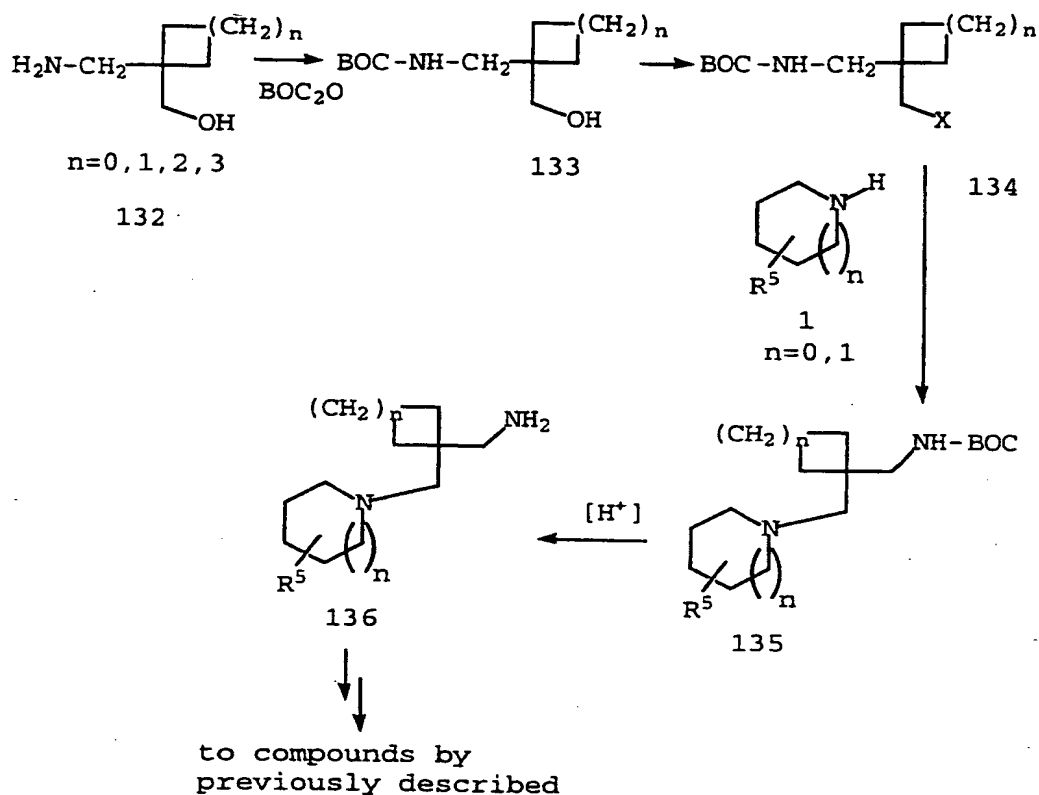

A method to introduce cycloalkyl groups at $\text{R}^{11}\text{R}^{12}$ is shown in Scheme 18. Protection of the nitrogen of compounds 137 which are commercially available yields 138 (the protecting group may be BOC, CBZ, or any other compatible protecting group) by procedures familiar to one skilled in the art. Esterification by any one of a number of procedures familiar to one skilled in the art (for example A. Hassner and V. Alexanian, Tet. Lett, 1978, 46, 4475-8) followed by reduction with DIBAL (or alternatively reduction to the alcohol with, for example, LiBH_4 , followed by Swern oxidation (op. cit.)) yields aldehyde 139. One carbon homologation via the Wittig reaction followed by hydrolysis of the vinyl ether yields aldehyde 141. Reductive amination (Abdel-Magid, A. F., et al. Tet. Lett. 1990, 31, (39) 5595-5598) yields 142 followed by

deprotection yields amine 143 which can be elaborated to the compounds of this invention by the methods previously discussed. Of course, aldehyde 139 can be reacted with R^9 or R^{10} MgBr or R^9 or R^{10} Li with or without $CeCl_3$ to yield an alcohol which can be oxidized to a ketone. Wittig one-carbon homologation on this ketone as described above followed by hydrolysis yields 141 where the $-CH_2CHO$ is substituted with one R^9 or R^{10} group ($-CHR^9$ or $R^{10}CHO$).

SCHEME 18

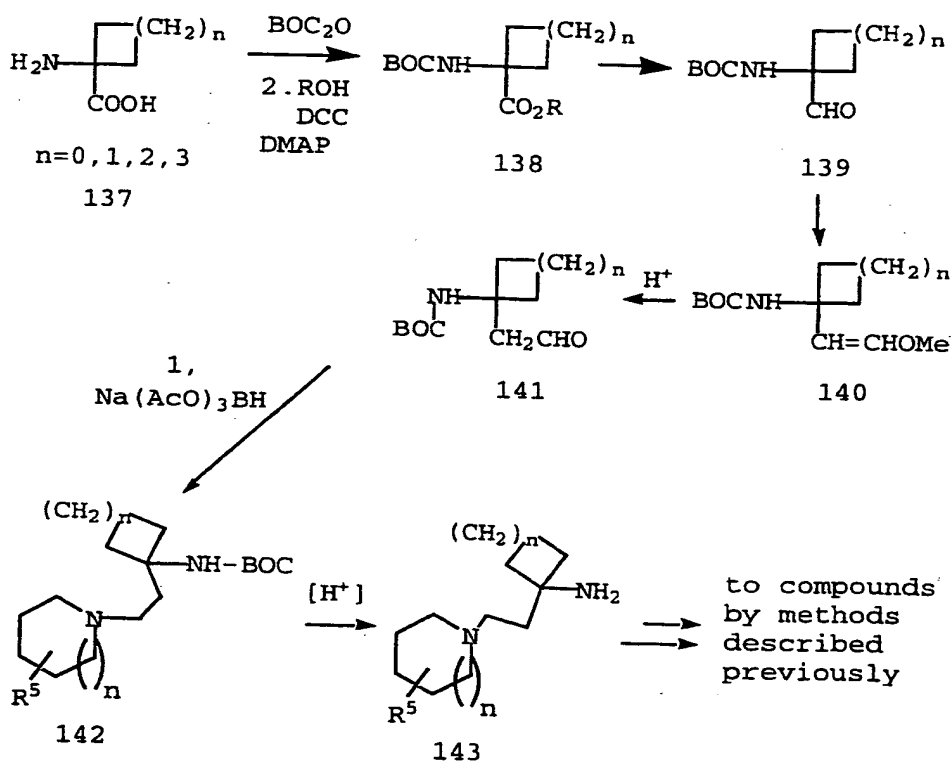

10

Aldehyde 141 ($-CH_2CHO$) or its monosubstituted analog synthesized above ($-CHR^9$ or $R^{10}CHO$) can undergo alkylation with R^9 or $R^{10}X$ where X is as defined in Scheme 1 to yield compound 141 containing one or both of the R^9 and R^{10} substituents alpha to the aldehyde group. Alkylation can be performed using LDA or lithium bistrimethylsilyl amide amongst other bases in an inert solvent such as ether, THF, etc., at -78

°C to room temperature. Aldehyde 141 (-CH₂CHO) or its substituted analogs synthesized above (i.e., -CHR⁹R¹⁰CHO) can undergo reductive amination with 1 and subsequent elaboration to the compounds of this invention. Aldehyde 141 (-CH₂CHO) or its substituted analogs synthesized above (i.e., -CHR⁹R¹⁰CHO) can also undergo 1,2-addition with R⁷or⁸MgBr or R⁷or⁸Li to yield the corresponding alcohol -CH₂CHR⁷or⁸OH or -CHR⁹R¹⁰CHR⁷or⁸OH. The alcohol may then be tosylated, mesylated, triflated, or converted to Cl, Br, or I by procedures familiar to one skilled in the art and displaced with pyrrolidine/piperidine 1 to yield, after subsequent deprotection and elaboration, the compounds of this invention. Or else alcohol -CH₂CHR⁷or⁸OH or -CR⁹R¹⁰CHR⁷or⁸OH can be oxidized (i.e., Swern, op. cit.) to the ketone and reductively aminated with 1 and subsequently elaborated to the compounds of this invention. Or else alcohol -CH₂CHR⁷or⁸OH or -CR⁹R¹⁰CHR⁷or⁸OH can be oxidized (i.e., Swern, op. cit.) to the ketone and reacted once more with R⁷or⁸MgBr or R⁷or⁸Li to yield the corresponding alcohol -CH₂CR⁷R⁸OH or -CR⁹R¹⁰CR⁷R⁸OH. If the ketone enolizes easily, CeCl₃ may be used together with the Grignard or lithium reagent. The alcohol can again be tosylated, mesylated, triflated, or converted to Cl, Br, or I by procedures familiar to one skilled in the art and displaced with pyrrolidine/ piperidine 1 to yield, after subsequent deprotection and elaboration, the compounds of this invention. Thus each one of the R⁷, R⁸, R⁹, and R¹⁰ groups may be introduced into compounds 141, 142 and 143 and and, of course, in the compounds of this invention, by the methods discussed above.

A method for the synthesis of N-substituted heterocycles at R⁵ is shown in Scheme 19. The heterocycle can be deprotonated with NaH or by other bases familiar to one skilled in the art, in a solvent such as DMF, THF, or another appropriate non-hydroxylic solvent and reacted with piperidine or pyrrolidine 143 at room temperature to the reflux temperature of the solvent. Deprotection and

elaboration as described before yields compounds where R⁵ contains an N-substituted heterocycle. If the nitrogen atom of the heterocycle is sufficiently nucleophilic, then an acid scavenger, such as K₂CO₃, KHCO₃, Na₂CO₃, NaHCO₃, amongst others, can be used in place of NaH, employing THF, DMF, or methyl ethyl ketone as solvents. In this case hydroxylic solvents may be used as well, such as methanol, ethanol, etc. from room temperature to the reflux temperature of the solvent. Compound 143 as well as its other positional isomers are available, for example, from commercially available 4-hydroxymethylpiperidine, 2-, 3-, and 4-carboethoxypiperidine, L- or D-proline ethyl ester, or from methyl 1-benzyl-5-oxo-3-pyrrolidinecarboxylate by methods familiar to one skilled in the art and as discussed previously in this application.

SCHEME 19

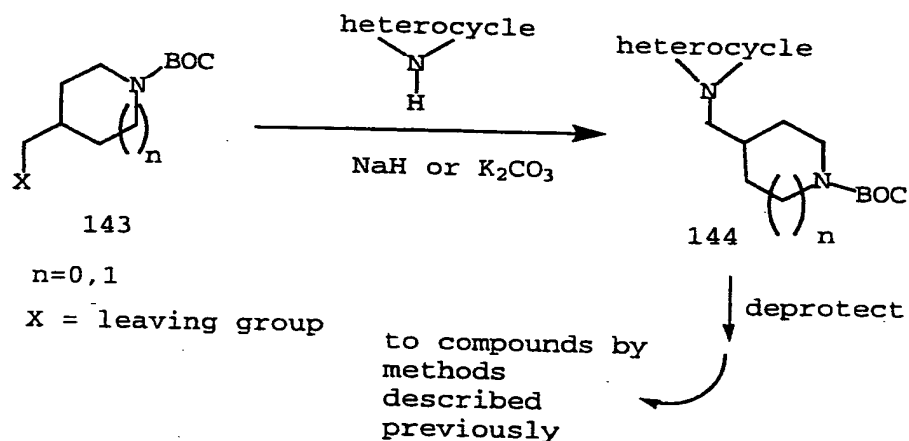

A method for the synthesis of C-substituted heterocycles at R⁵ is shown in Scheme 20. Many heterocycles such as the ones shown in Scheme 20, but not limited thereto, can be metallated with strong bases such as LDA, n-BuLi, sec-BuLi, t-BuLi, etc. to yield the corresponding anionic species. These anions may also be generated via halogen-metal exchange employing n-BuLi, or other alkyllithium reagents. These reactions may be

performed in THF, ether, dioxane, DME, benzene, etc. at -78 °C to room temperature.

SCHEME 20

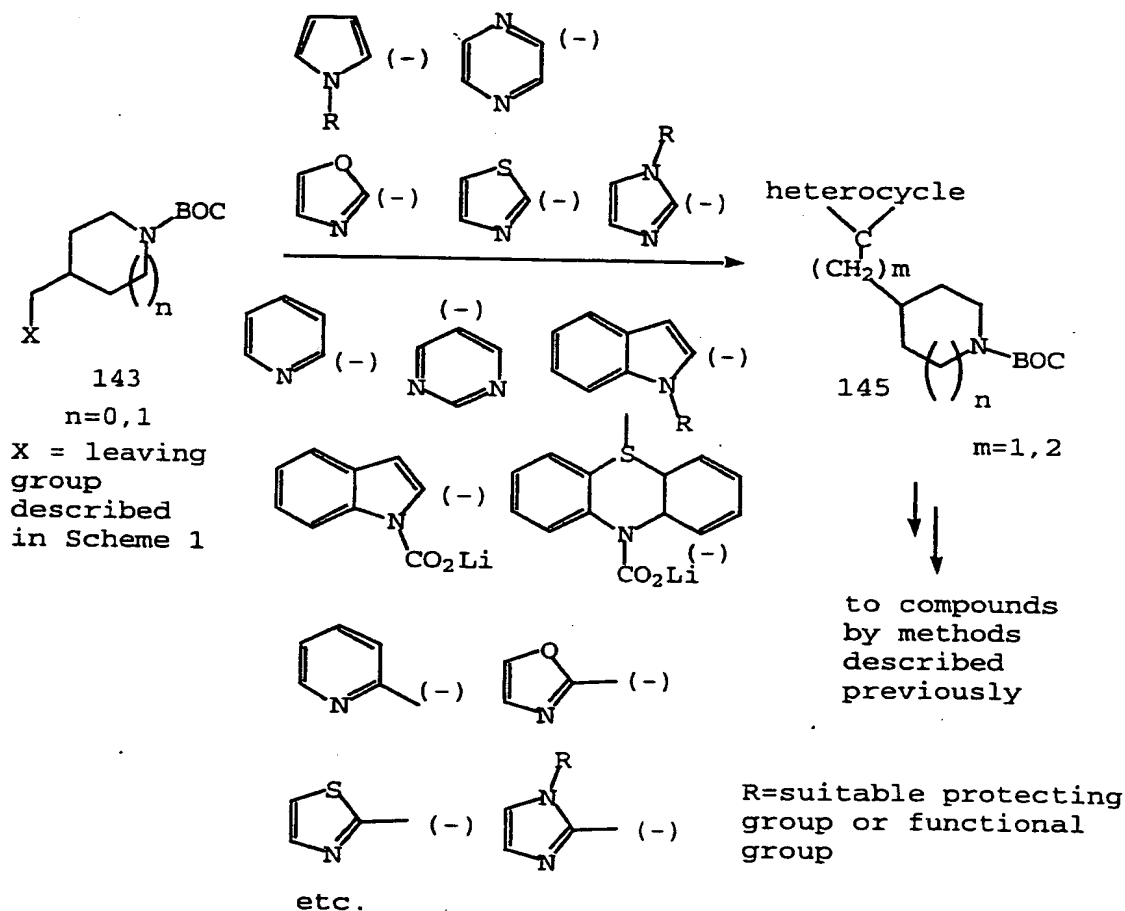

- 5 For reviews of these metallations and halogen-metal exchange reactions see *Organometallics in Organic Synthesis*, FMC Corp., Lithium Division, 1993, pp. 17-39; *Lithium Link*, FMC Corp., Spring 1993, pp. 2-17; *n-Butyllithium in Organic Synthesis*, Lithium Corp. of America, 1982, pp. 8-16; G. Heinisch, T. Langer, P. Lukavsky, *J. Het. Chem.* 1997, 34, 17-19. The anions can then be quenched with electrophile 143 or its positional isomers to yield the corresponding C-alkylated heterocyclic pyrrolidine or piperidine 145.

15

SCHEME 21

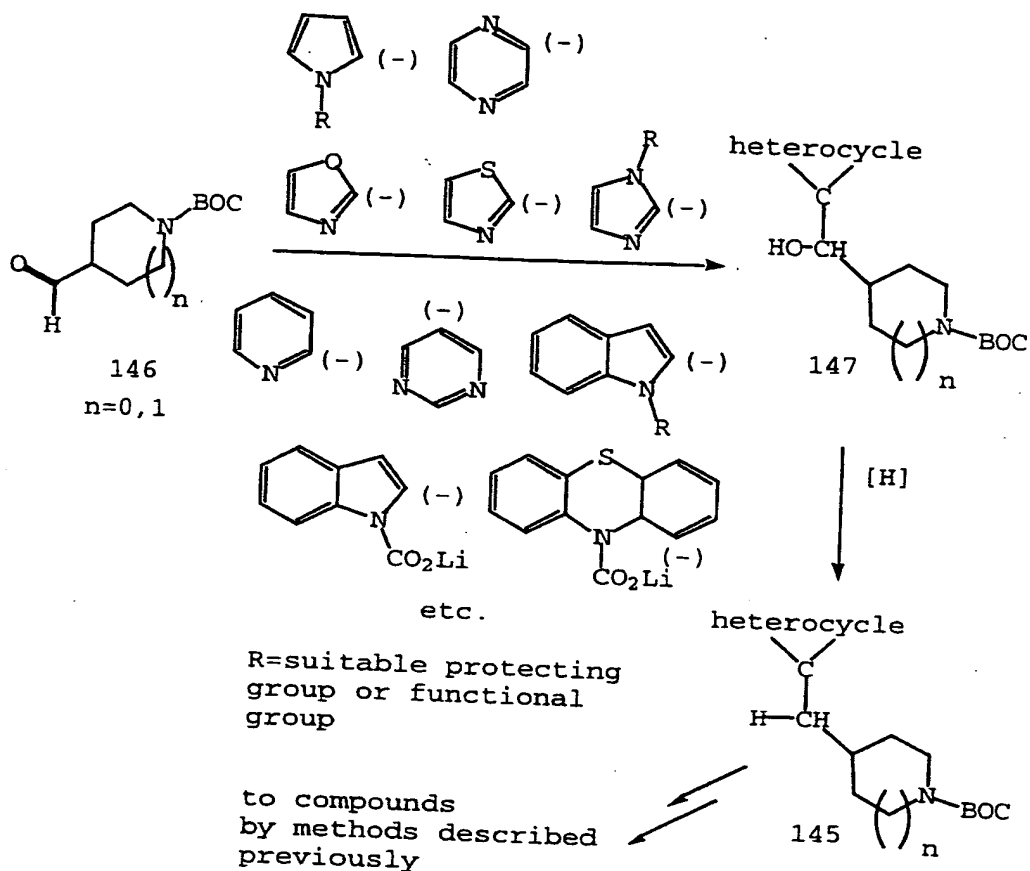

Another method for the synthesis of C-substituted heterocyclic-methylpyrrolidines or piperidines is shown in Scheme 21. The protected aldehyde **146** is reacted with the anion of the heterocycle (its generation as described previously) at $-78\text{ }^{\circ}\text{C}$ to room temperature with or without CeCl_3 in an inert solvent such as THF, ether, dioxane, DME, benzene, etc. to yield carbinol **147**. Catalytic hydrogenation of the alcohol yields the corresponding methylene compound **145**. Other reduction methods include $\text{Et}_3\text{SiH/TFA}$ (J. Org. Chem. 1969, 34, 4; J. Org. Chem. 1987, 52, 2226) amongst others familiar to one skilled in the art. It is understood by one skilled in the art that the aldehyde group can be located in other positions instead of, for example, the 4-position of piperidine in compound

146 as depicted in Scheme 21. It is to be understood that other heterocycles may also be used besides the ones shown in Scheme 20 and 21.

The anions of the methyl-substituted heterocycles may also be reacted with a BOC-protected piperidone or pyrrolidone (148) to yield alcohols 149 as shown in Scheme 22 (see above reviews on metallations for references). These alcohols may be reduced using PtO₂ and TFA (P. E. Peterson and C. Casey, J. Org. Chem. 1964, 29, 2325-9) to yield piperidines and pyrrolidines 150. These can subsequently be taken on to the compounds of this invention as described previously. It is understood by one skilled in the art that the carbonyl group can be located in other positions instead of, for example, the 4-position of piperidine in compound 148 as depicted in Scheme 22. It is to be understood that other heterocycles may also be used besides the ones shown in Scheme 22.

SCHEME 22

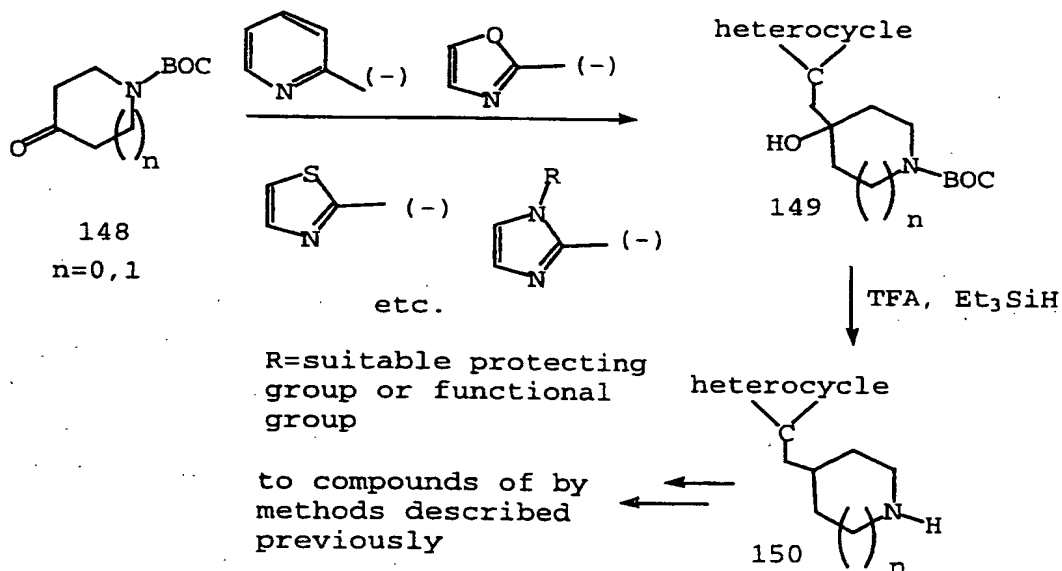

20

One may also react aryl (phenyl, naphthyl, etc.) anions, generated either by halogen-metal exchange or by ortho-directed metallation (Snieckus, V. Chem. Rev. 1990,

90, 879-933) using n- or s- or t-BuLi in a non-hydroxylic solvent such as THF, ether, etc., with or without TMEDA and allow them to react with compounds 143, 146, and 148 with subsequent elaboration to yield the compounds of this invention by the methods depicted in Schemes 19-22.

Another method for the preparation of C-substituted heterocycles is shown in Scheme 23. Protected piperidone 148 undergoes a Wittig reaction with heterocyclic phosphorous ylides to yield 151. Hydrogenation over a noble metal catalyst such as Pd in an alcoholic solvent or with an optically active transition metal catalyst (see asymmetric hydrogenation references of Parshall and Coleman, op. cit.) yields 152 which can be further elaborated into the compounds of this invention by the procedures described previously. It will be appreciated by one skilled in the art that the carbonyl group can be located in other positions instead of, for example, the 4-position of piperidine in compound 148 as depicted in Scheme 23. It is to be understood that other heterocycles may also be used besides the ones shown in Scheme 23.

Scheme 23

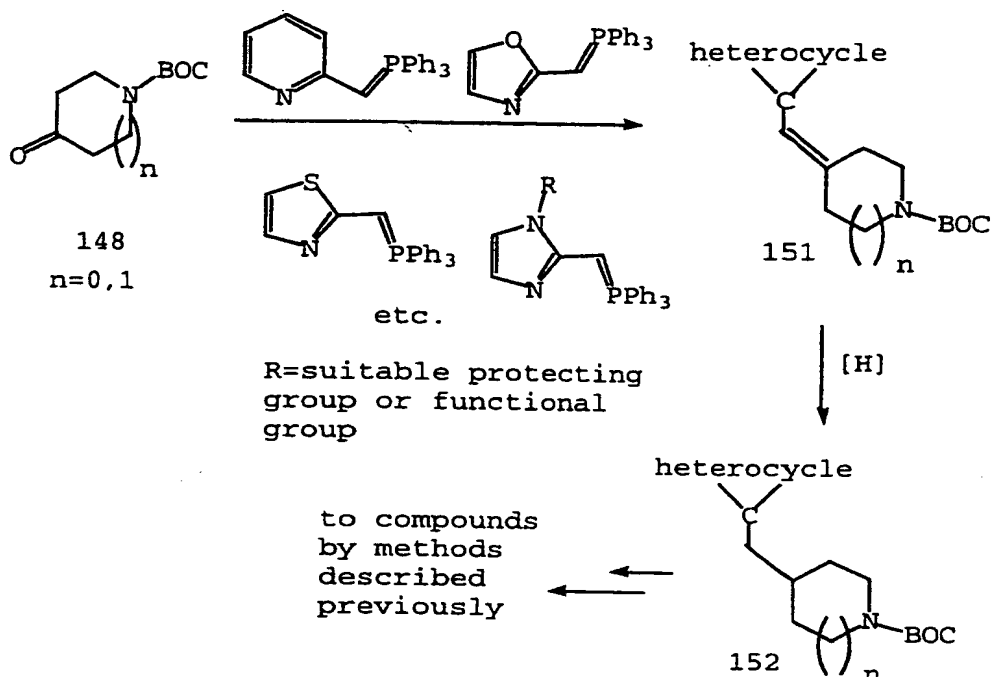

Syntheses of amines 9, 10, and the amines which are precursors to isocyanates or isothiocyanates 5 will now be discussed. For example, 3-nitrobenzeneboronic acid (153: Scheme 24) is commercially available and can undergo Suzuki couplings (Suzuki, A. Pure Appl. Chem. 1991, 63, 419) with a wide variety of substituted iodo- or bromo aryls (aryls such as phenyl, naphthalene, etc.), heterocycles, alkyls, akenyls (Moreno-manas, M., et al., J. Org. Chem., 1995, 60, 2396), or alkynes. It can also undergo coupling with triflates of aryls, heterocycles, etc. (Fu, J.-m, Snieckus, V. Tet. Lett. 1990, 31, 1665-1668). Both of the above reactions can also undergo carbonyl insertion in the presence of an atmosphere of carbon monoxide (Ishiyama, et al., Tet. Lett. 1993, 34, 7595). These nitro-containing compounds (155 and 157) can then be reduced to the corresponding amines either via catalytic hydrogenation, or via a number of chemical methods such as Zn/CaCl₂ (Sawicki, E. J. Org Chem 1956, 21). The carbonyl insertion compounds

(158) can also undergo reduction of the carbonyl group to either the CHOH or CH₂ linkages by methods already discussed (NaBH₄ or Et₃SiH, TFA, etc.). These amines can then be converted to isocyanate 5 via the following methods

5 (Nowakowski, J. J Prakt Chem/Chem-Ztg 1996, 338 (7), 667-671; Knoelker, H.-J. et al., Angew Chem 1995, 107 (22), 2746-2749; Nowick, J. S. et al., J Org Chem 1996, 61 (11), 3929-3934; Staab, H. A.; Benz, W.; Angew Chem 1961, 73); to isothiocyanate 5 via the following methods

10 (Strekowski L. et al., J Heterocycl Chem 1996, 33 (6), 1685-1688; Kutschy, Pet al., Synlett 1997, (3), 289-290); to carbamoyl chloride 11 (after 156 or 158 is reductively aminated with an R² group) (Hintze, F.; Hoppe, D.; Synthesis (1992) 12, 1216-1218); to thiocarbamoyl chloride

15 11 (after 156 or 158 is reductively aminated with an R² group) (Ried, W.; Hillenbrand, H.; Oertel, G.; Justus Liebigs Ann Chem 1954, 590); or just used as 9, or 10 (after 156 or 158 is reductively aminated with an R² group), in synthesizing the compounds of this invention by

20 the methods depicted in Scheme 1.

SCHEME 24

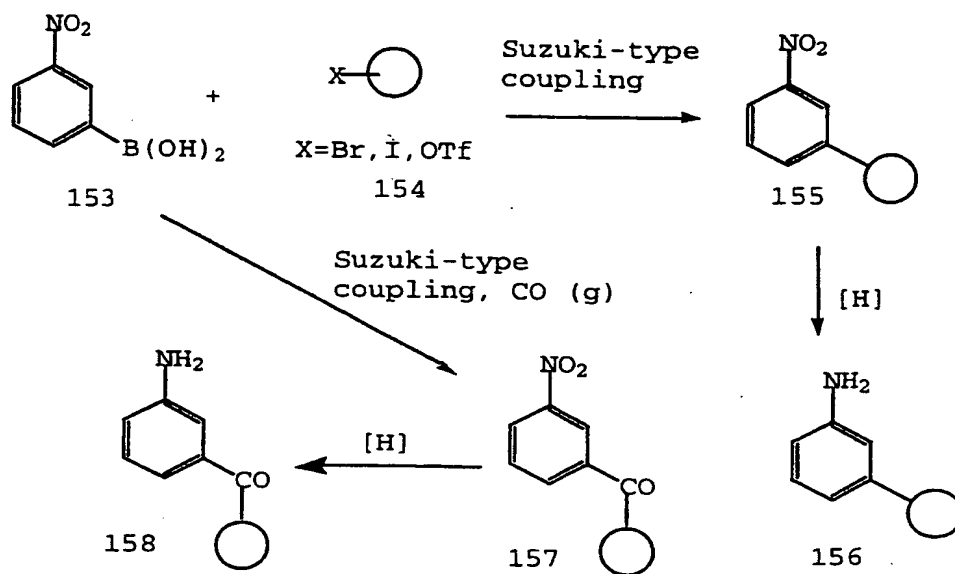

make isocyanate or
 isothiocyanate 5,
 or carbamoyl chlorides 11,
 or used as 9 or 10 to make
 the compounds of this
 invention as described for
 the compounds of Scheme 1

Likewise, protected aminobromobenzenes or triflates or
 protected aminobromoheterocycles or triflates 159 (Scheme
 5 25) may undergo Suzuki-type couplings with arylboronic
 acids or heterocyclic boronic acids (160). These same
 bromides or triflates 159 may also undergo Stille-type
 coupling (Echavarren, A. M., Stille, J.K. J. Am. Chem.
 Soc., 1987, 109, 5478-5486) with aryl, vinyl, or
 10 heterocyclic stannanes 163. Bromides or triflates 159 may
 also undergo Negishi-type coupling with other aryl or
 heterocyclic bromides 164 (Negishi E. Accts. Chem. Res.
 1982, 15, 340; M. Sletzing, et al., Tet. Lett. 1985, 26,
 2951). Deprotection of the amino group yields an amine
 15 with can be coupled to make a urea and other linkers

containing Z as described above and for Scheme 1. Amino protecting groups include phthalimide, 2,4-dimethyl pyrrole (S. P. Breukelman, et al. J. Chem. Soc. Perkin Trans. I, 1984, 2801); N-1,1,4,4-Tetramethyldisilyl-azacyclopentane (STABASE) (S. Djuric, J. Venit, and P. Magnus Tet. Lett 1981, 22, 1787) and others familiar to one skilled in the art.

SCHEME 25

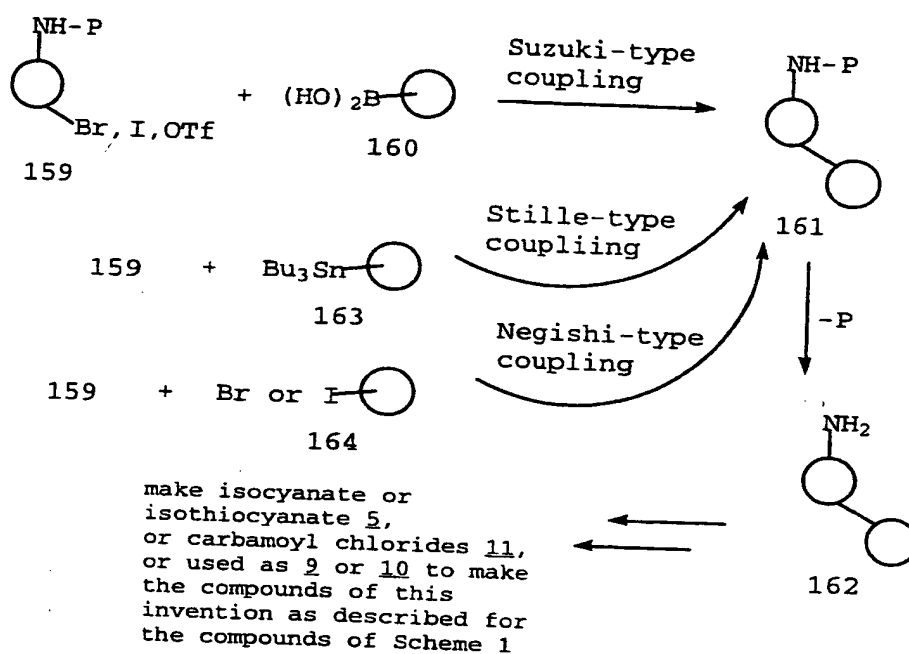

10

Compounds where R⁷ and R⁸ are taken together to form =NR^{8b} can be synthesized by the methods in Scheme 25a. Reacting 1 with nitrile a with CuCl catalysis forms amidine b where R^{8b} is H (Rousselet, G.; Capdevielle, P.; Maumy, M.; Tetrahedron Lett. 1993, 34 (40), 6395-6398). Note that the urea portion may be in final form or in precursor form (for example, a protected nitrogen atom; P = protecting group such as STABASE, bis-BOC, etc., as was discussed previously) which may be subsequently elaborated into the compounds of this invention. Compounds b may be also synthesized by reacting iminoyl chloride c with

20

pyrrolidine/piperidine 1 to yield b where R^{8b} is not H (Povazanec, F., et al., J. J. Heterocycl. Chem., 1992, 29, 6, 1507-1512). Iminoyl chlorides are readily available from the corresponding amide via PCl_5 or CCl_4/PPh_3 (Duncia, J.V. et al., J. Org. Chem., 1991, 56, 2395-2400). Again, the urea portion may be in final form or in precursor form.

Scheme 25a

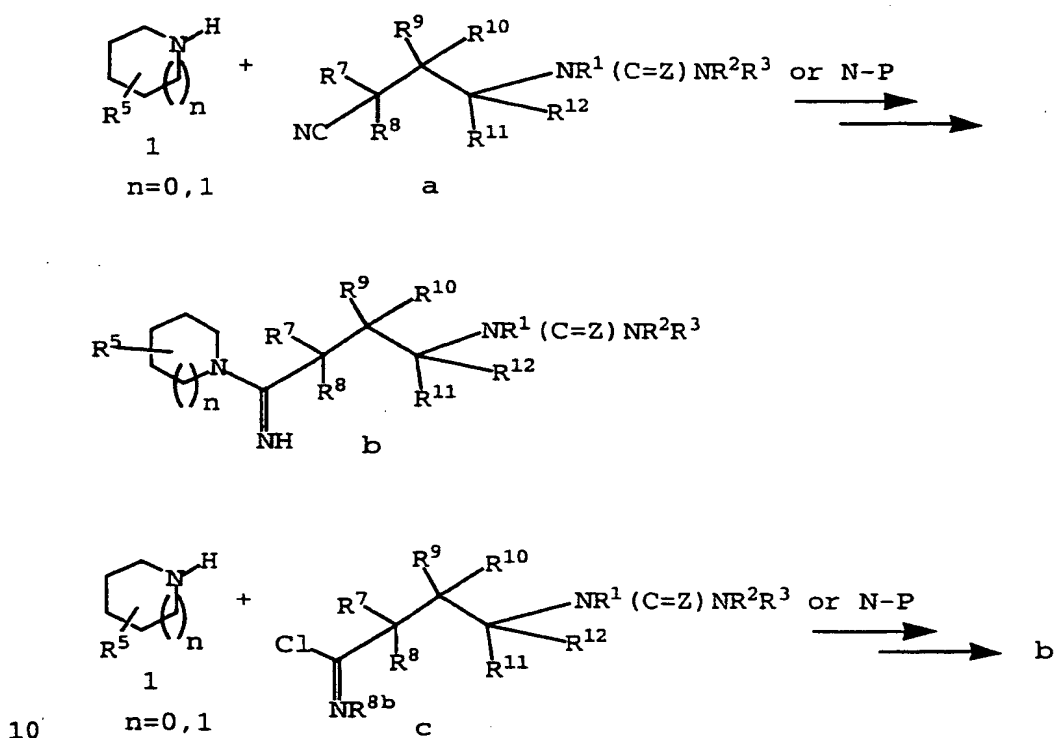

Many amines are commercially available and can be used as 9, 10, or used as precursors to isocyanates or isothiocyanates 5. There are numerous methods for the synthesis of non-commercially available amines familiar to one skilled in the art. For example, aldehydes and ketones may be converted to their O-benzyl oximes and then reduced with LAH to form an amine (Yamazaki, S.; Ukaji, Y.;

Navasaka, K.; Bull Chem Soc Jpn 1986, 59, 525). Ketones and trifluoromethylketones undergo reductive amination in the presence of $TiCl_4$ followed by $NaCNBH_4$ to yield amines (Barney, C.L., Huber, E.W., McCarthy, J.R. Tet. Lett. 1990, 31, 5547-5550). Aldehydes and ketones undergo reductive amination with $Na(AcO)_3BH$ as mentioned previously to yield amines (Abdel-Magid, A. F., et al. Tet. Lett. 1990, 31, (39) 5595-5598). Amines may also be synthesized from aromatic and heterocyclic OH groups (for example, phenols) via the Smiles rearrangement (Weidner, J.J., Peet, N.P. J. Het. Chem., 1997, 34, 1857-1860). Azide and nitrile displacements of halides, tosylates, mesylates, triflates, etc. followed by LAH or other types or reduction methods yield amines. Sodium diformyl amide (Yinglin, H., Hongwen, H. Synthesis 1989 122), potassium phthalimide, and bis-BOC-amine anion can all displace halides, tosylates, mesylates, etc., followed by standard deprotection methods to yield amines, procedures which are familiar to one skilled in the art. Other methods to synthesize more elaborate amines involve the Pictet-Spengler reaction, imine/immonium ion Diels-Alder reaction (Larsen, S.D.; Grieco, P.A. J. Am. Chem. Soc. 1985, 107, 1768-69; Grieco, P.A., et al., J. Org. Chem. 1988, 53, 3658-3662; Cabral, J. Laszlo, P. Tet. Lett. 1989, 30, 7237-7238; amide reduction (with LAH or diborane, for example), organometallic addition to imines (Bocoum, A. et al., J. Chem. Soc. Chem. Comm. 1993, 1542-4) and others all of which are familiar to one skilled in the art.

Compounds containing an alcohol side-chain alpha to the nitrogen of the piperidine/pyrrolidine ring can be synthesized as shown in Scheme 25b. Only the piperidine case is exemplified, and it is to be understood by one skilled in the art that the alpha-substituted pyrrolidines may be synthesized by a similar route. It is also understood that appropriate substituents may be present on the piperidine/pyrrolidine ring. A 4-benzylpiperidine 196 is protected with a BOC group. The BOC-piperidine 197 is

then metallated under conditions similar to those Beak, et al. (P. Beak and W.-K. Lee, J. Org. Chem. 1990, 55, 2578-2580, and references therein) and quenched with an aldehyde to yield alcohol 198. The metallation may also be done
5 enantioselectively using sparteine (P. Beak, S.T. Kerrick, S. Wu, J. Chu J. Am. Chem. Soc. 1994, 116, 3231-3239). This alcohol can be deprotonated with NaH and cyclized to carbamate 198a which permits structural assignments of the erythro and threo isomers. Deprotection with base yields
10 aminoalcohol 199. Subsequent N-alkylation yields phthalimidoalkylpiperidine 201. It is to be understood that the alkyl chain does not necessarily have to be n-propyl, but that n-propyl was chosen for demonstration purposes only. Deprotection of the phthalimido group with
15 hydrazine yields amine 202. Finally, reaction with an isocyanate or via any of the previously described conditions described in Scheme 1 yields urea 203. If an isocyanate is used, the isocyanate can add twice to yield urea-carbamate 204.

Scheme 25b

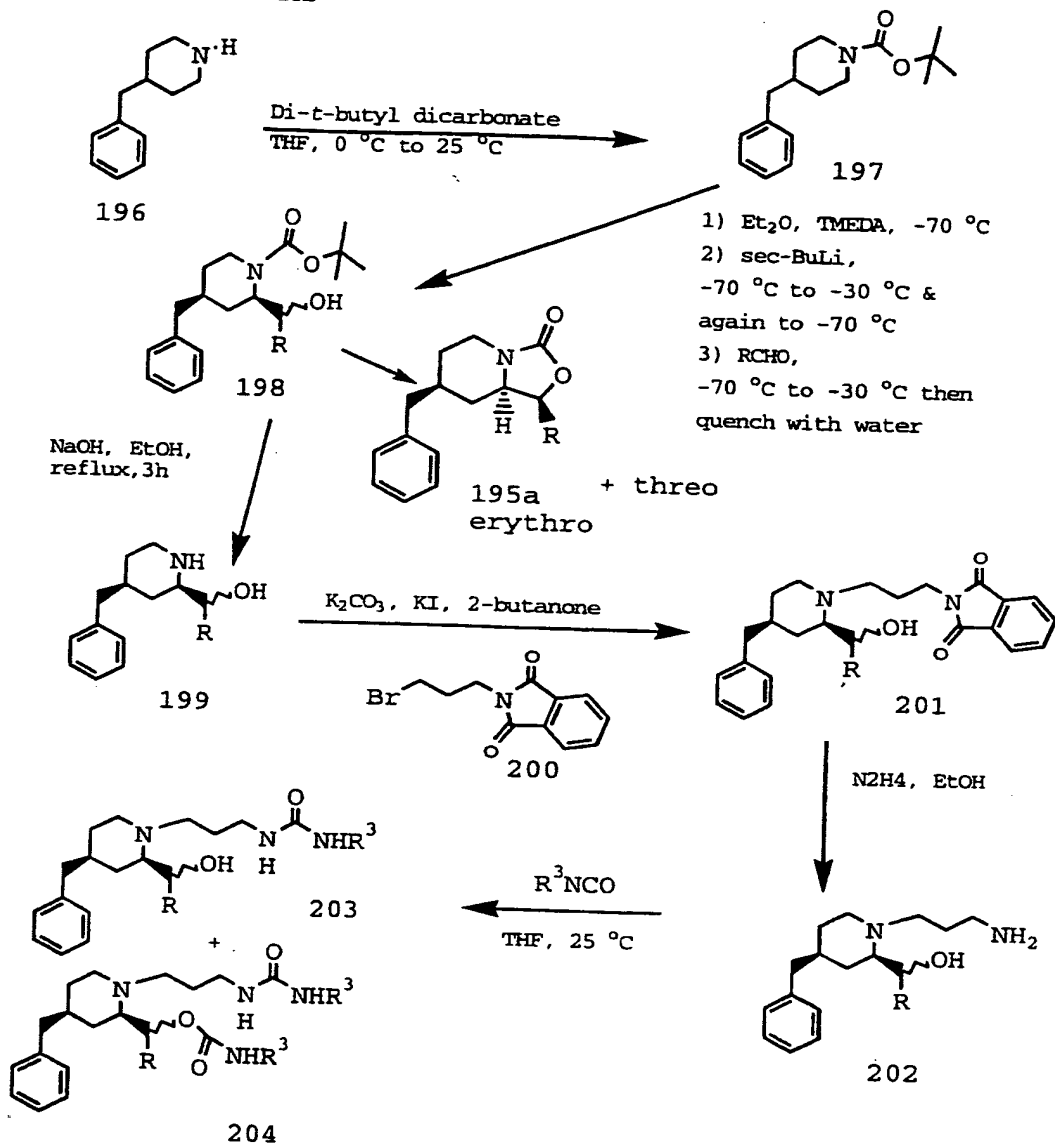

Compounds where Z = N-CN, CHNO₂, and C(CN)₂ can be synthesized by the methods shown in Scheme 25c. Thus amine 208 reacts with malononitrile 207 neat or in an inert solvent at room temperature to the reflux temperature of the solvent, or at the melting point of the solid/solid mixture, to yield malononitrile 206. This in turn can undergo reaction with amine 205 under similar conditions stated just above to yield molononitrile 209. Likewise, a similar reaction sequence may be used to make 212 and 215

[for Z = C(CN) 2], see for example P. Traxler, et al., J. Med. Chem. (1997), 40, 3601-3616; for Z = N-CN, see K. S. Atwal, J. Med. Chem. (1998) 41, 271; for Z = CHNO₂, see J. M. Hoffman, et al., J. Med. Chem. (1983) 26, 140-144).

5

Scheme 25c.

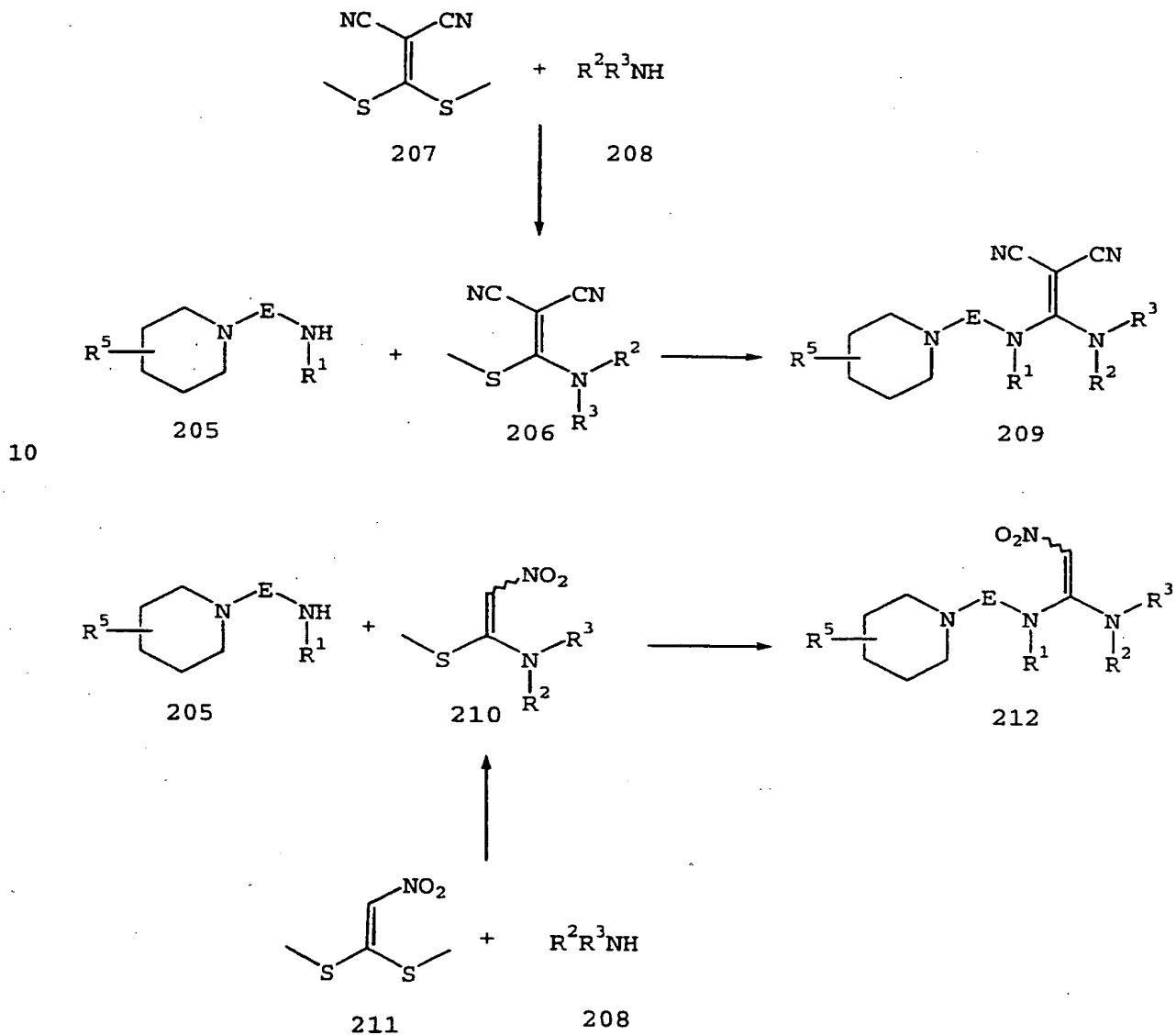

15

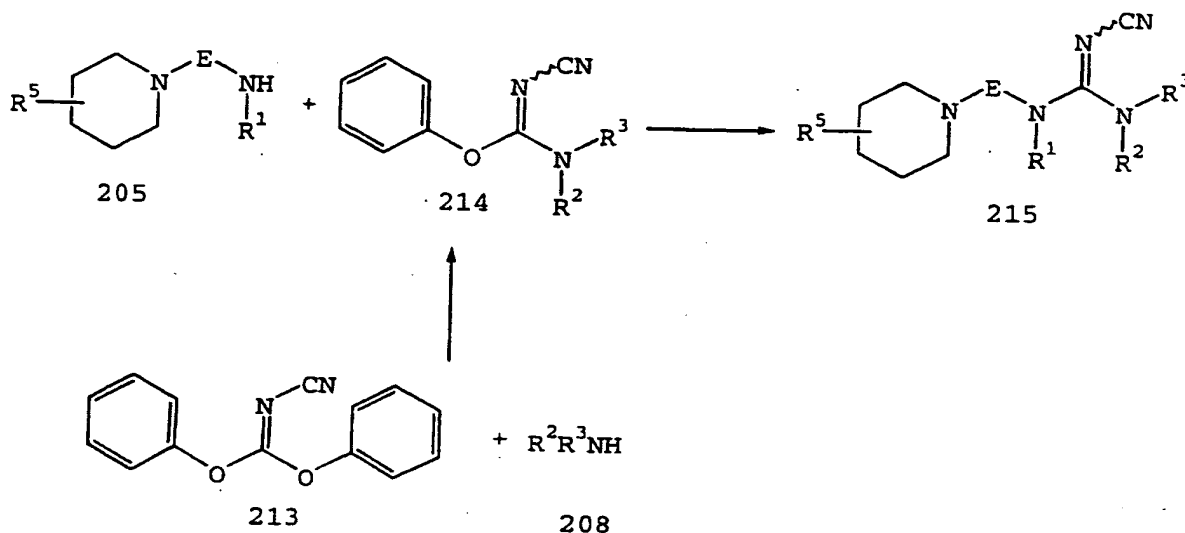
EXAMPLES

5 The compounds of this invention and their preparation can be understood further by the following working examples. These examples are meant to be illustrative of the present invention, and are not to be taken as limiting thereof.

10

EXAMPLE 1

Part A: Preparation of 4-benzyl-1-(3-N-phthalimido-n-propyl)piperidine

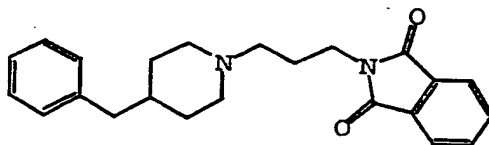

15

4-benzylpiperidine (8.0 g, 45.6 mmol, 1eq), N-(3-bromopropyl)-phthalimide (13.5 g, 50.2 mmol, 1.1 eq), potassium iodide (7.6 g, 45.6 mmol, 1 eq) and potassium carbonate (2.6 g, 91.3 mmol, 2 eq) were refluxed in 125 mL of 2-butanone. The reaction was worked up after 5 hours by filtering off the inorganic solids then adding EtOAc and rinsing the organic layer 2X with water. The organic layer was dried over magnesium sulfate then the solvent removed

20

in vacuo to obtain an amber oil. The oil was purified by flash chromatography in 100% EtOAc to remove impurities then 8:2 chloroform/methanol to isolate 3.67 g of the product as a light amber oil. NMR(300 MHz, CDCl₃) δ 8.00-
 5 7.80 (m, 2H); 7.80-7.60 (m, 2H); 7.35-7.10 (m, 3H); 7.08 (d, 2H, J=7 Hz); 3.76 (t, 2H, J = 7 Hz); 2.83 (d, 2H, J=10 Hz); 2.45-2.30 (m, 4H); 1.95-1.30 (m, 7H); 1.20-0.90 (m, 2H).

Part B: Preparaton of 4-benzyl-1-(3-amino-n-prop-1-
 10 yl)piperidine

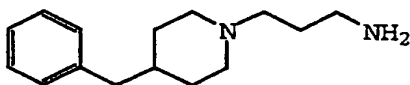

4-benzyl-1-(3-N-phthalimido-n-prop-1-yl)piperidine
 15 (13.72 g, 37.9 mmol, 1 eq.) was dissolved in 200 mL of EtOH at 25 °C under N₂, the anhydrous hydrazine (2.38 mL, 75.7 mmol, 2 eq.) was added. The solution was then refluxed during which time a white precipitate formed. The reaction was worked up after refluxing 4 hours by filtering off the
 20 solids. The solvent was removed in vacuo to obtain an oil which was re-rotovapped from toluene to remove excess hydrazine. Obtained an oil which was stirred in Et₂O. Insoluble material was filtered then the solvent removed in vacuo to obtain 5.55g of an amber oil as product. NMR
 25 (300 MHz, CDCl₃) δ 7.40-7.21 (m, 2H); 7.21-7.05 (m, 3H); 2.92 (d, 2H, J=10 Hz); 2.73 (t, 2H, J=7 Hz); 2.53 (d, 2H, J=7 Hz); 2.40-2.20 (m, 2H); 1.84 (t of t, 2H, J=7,7 Hz); 1.75-1.10 (m, 9H).

30 Part C: N-(3-cyanophenyl)-N'-[3-[4-(phenylmethyl)-1-piperidinyl]propyl]urea

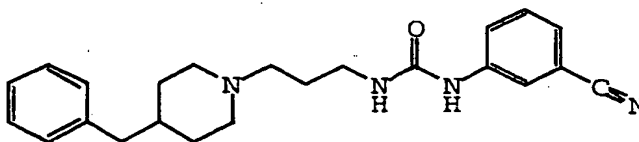

4-benzyl-1-(3-amino-n-prop-1-yl)piperidine (300 mg, 1.29 mmol, 1 eq) was dissolved in THF at 25 °C under N₂ then 3-cyanophenyl isocyanate (186 mg, 1.29 mmol, 1 eq) was added. TLC after 30 minutes shows the reaction complete. The solvent was removed *in vacuo* then the residue was purified over silica gel in 100% EtOAc to 8:2 chloroform/MeOH to yield 437 mg of an amber oil as product. NMR (300 MHz, DMSO-d₆) δ 9.90-9.50 (m, 1H); 9.32 (s, 1H); 7.93 (s, 1H); 7.59 (d, 1H, J= 7Hz); 7.43 (t, 1H, J= 7Hz); 7.40-7.24 (m, 3H); 7.24-7.10 (m, 3H); 6.68 (t, 1H, J=7 Hz); 3.50-3.25 (m, 2H); 3.25-3.07 (m, 2H); 3.07-2.90 (m, 2H); 2.90-2.60 (m, 2H); 2.60-2.40 (m, 2H); 2.00-1.60 (m, 5H); 1.60-1.30 (m, 2H).

EXAMPLE 2

Part A: Preparation of 4-benzyl-1-carbomethoxymethyl-1-[3-(3-cyanophenylaminocarbonylamino)prop-1-yl]piperidinium bromide

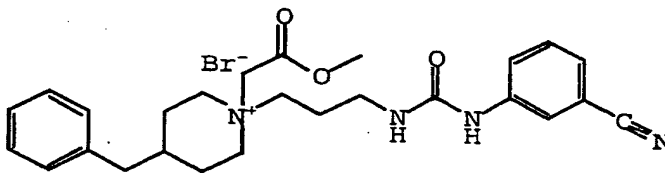

4-benzyl-1-[3-(3-cyanophenylaminocarbonylamino)prop-1-yl]piperidine (50mg, 0.133 mmol, 1 eq), was dissolved in acetone at 25 °C under N₂ then methyl bromoacetate (13μL, 0.133 mmol, 1 eq), was added. After 16 hours, the solvent was removed *in vacuo* and the residue was purified over silica gel in 100% EtOAc to 8:2 chloroform/MeOH to yield 50 mg of white solids as product. NMR (300MHz, CD₃OD) δ 8.00-7.80 (m, 1H) ; 7.65-7.45 (m, 1H); 7.45-7.33 (m, 1H); 7.33-7.05 (m, 6H); 4.50-4.25 (m, 2H); 4.00-3.60 (m, 5H); 3.50-3.20 (m, 6H); 2.70-2.50 (m, 2H); 2.10-1.60 (m, 7H).

EXAMPLE 3

Part A: Preparation of 1-(t-Butoxycarbonyl)-3-piperidone

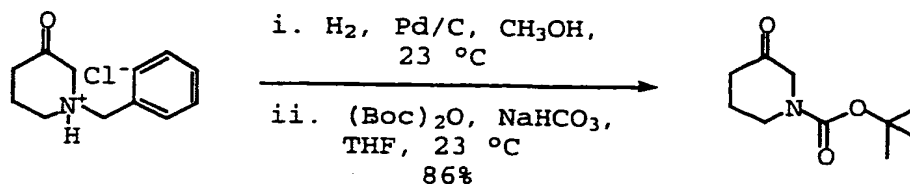

5 To a deep yellow solution of 1-benzyl-3-piperidone hydrochloride (3.00 g, 1.33 mmol, 1 equiv) in methanol (100 mL) was added 10 wt. % (dry basis) palladium on activated carbon (600 mg) under a stream of nitrogen. The resulting black suspension was deoxygenated by alternate evacuation and flushing with nitrogen (3x) followed by alternate evacuation and flushing with hydrogen (3x). The reaction suspension was then shaken vigorously under a hydrogen atmosphere of 55 psi. After 12 hours, gravity filtration of the suspension and concentration of the resulting

10 filtrate in vacuo yielded crude 3-piperidone as a viscous light green oil. The oil was immediately treated with tetrahydrofuran (150 mL) and di-t-butylidicarbonate (4.73 g, 21.7 mmol, 0.98 equiv). Upon addition of saturated aqueous sodium bicarbonate (25 mL), the oil completely dissolved to give a light yellow suspension. After stirring the

20 suspension vigorously for 2 hours, the now white suspension was poured into aqueous hydrogen chloride (1N, 100 mL), and the layers were separated. The aqueous layer was extracted with ethyl acetate (3 x 70 mL), and the combined organic

25 layers were washed with saturated aqueous sodium chloride (50 mL), dried over sodium sulfate, and filtered. Concentration of the resulting filtrate in vacuo yielded 1-(t-butoxycarbonyl)-3-piperidone (3.79 g, 86%) as a white oily solid. ^1H NMR (300 MHz, CDCl_3), δ : 3.94 (s, 2H), 3.53

30 (t, 2H, $J = 6$ Hz), 2.41 (t, 2H, $J = 7$ Hz), 1.92 (m, 2H), 1.41 (s, 9H)

Part B: Preparation of 1',3-(2H)-Dehydro-3-benzyl-1-(t-butoxycarbonyl)piperidine

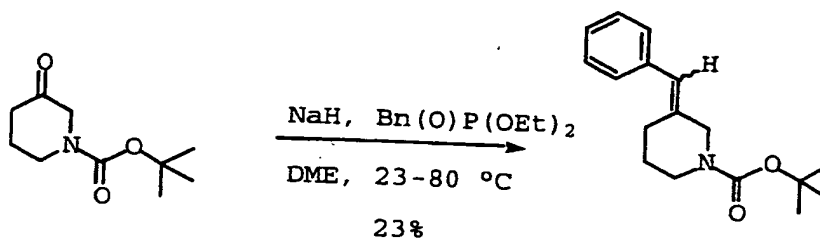

To a flame-dried 100-mL flask charged with sodium
 5 hydride (60% wt. dispersion in mineral oil; 601 mg, 15.0
 mmol, 2.3 equiv) and 1,2-dimethoxyethane (20 mL) was added
 benzyl diethylphosphite (3.42 g, 3.13 mL, 15.0 mmol, 2.3
 10 equiv) dropwise over a period of 5 min. After 10 min, 1-
 (t-butoxycarbonyl)-3-piperidone was added in one portion to
 the pale yellow suspension. The flask was fitted with a
 reflux condenser, and the resulting yellow-gray suspension
 at heated under reflux conditions for 2 hrs. Upon cooling
 to 23 °C, the reaction was poured into aqueous hydrogen
 15 chloride (0.20 N, 100 mL) and diethyl ether (75 mL). The
 layers were separated and the aqueous layer was basified
 with saturated aqueous sodium bicarbonate to pH 9. The
 aqueous layer was extracted with diethyl ether (4 x 75 mL),
 and the combined organic layers were dried over sodium
 20 sulfate. Filtration, concentration in vacuo, and
 purification of the resulting residue by flash column
 chromatography (5% ethyl acetate in hexanes) afforded a
 mixture of the desired olefin (410 mg, 23%) and the
 corresponding ethoxycarbamate (550 mg, 34%) as a clear oil.
 The ethoxycarbamate was removed in the subsequent step by
 25 flash column chromatography. ¹H NMR (300 MHz, CDCl₃), δ:
 7.30 (m, 2H), 7.18 (m, 3H), 6.42 (s, 1H), 4.02 (s, 2H),
 3.50 (t, 2H, J = 6 Hz), 2.51 (t, 2H, J = 5 Hz), 1.61 (m,
 2H), 1.49 (s, 9H). MS (CI), m⁺/z: (M+H)⁺ = 274, [(M+H)⁺ -
 (-C(O)OC(CH₃)₃)] 174.

30

Part C: Preparation of 1-(t-Butoxycarbonyl)-3-benzylpiperidine

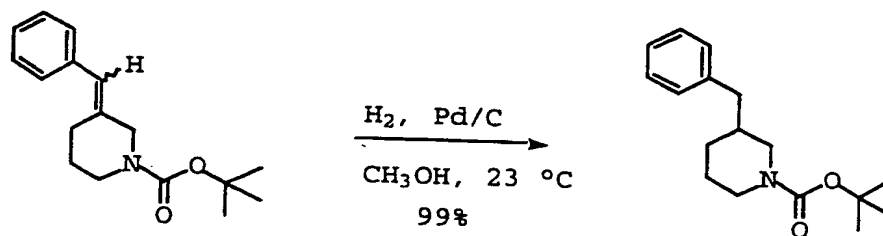

To a solution of impure product (410 mg, 1.50 mmol) obtained in the previous step in methanol (100 mL) was added 10 wt. % (dry basis) palladium on activated carbon (200 mg) under a stream of nitrogen. The resulting black suspension was deoxygenated by alternate evacuation and flushing with nitrogen (3x) followed by alternate evacuation and flushing with hydrogen (3x). The reaction suspension was then shaken vigorously under a hydrogen atmosphere of 55 psi. After 12 hours, gravity filtration of the suspension and concentration of the resulting filtrate in vacuo resulted in a pale yellow residue. Purification of this residue by flash column chromatography afforded 1-(t-butoxycarbonyl)-3-benzyl-piperidine (407 mg, 99%) as a clear oil. ^1H NMR (300 MHz, CDCl_3), δ : 7.23 (m, 2H), 7.14 (m, 3H), 3.86 (m, 2H), 2.75 (br m, 1H), 2.51 (m, 3H), 1.70 (br. m, 2H), 1.64 (br. m, 1H), 1.41 (s, 9H), 1.34 (br. m, 1H), 1.09 (br. m, 1H). MS (CI), m^+/z : ($M^+ + 1$) 276, [$(M+H)^+ - (-\text{C}(\text{O})\text{OC}(\text{CH}_3)_3$)] = 176.

Part D: 3-Benzylpiperidine hydrochloride

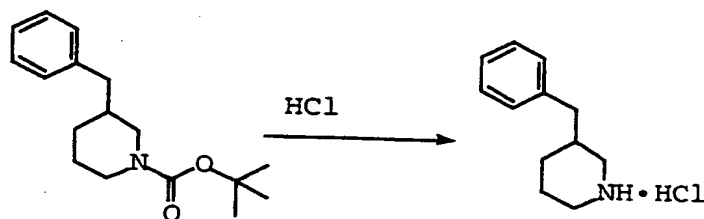

To a solution of 1-(t-butoxycarbonyl)-3-benzylpiperidine (400 mg, 1.45 mmol) in methanol (5 mL) was added hydrogen chloride in dioxane (4M, 15 mL). The

resulting yellow solution was stirred for 1 hr, at which time the reaction was concentrated in vacuo to provide 3-benzylpiperidine hydrochloride (308 mg, 100%) as an amorphous solid. $^1\text{H NMR}$ (300 MHz, CD_3OD), δ : 7.27 (m, 2H,), 7.19 (m, 3H), 3.29 (br. d, 1H, $J = 12\text{Hz}$), 3.20 (br. d, 1H, $J = 12\text{ Hz}$), 2.87 (br. t, 1H, $J = 12\text{ Hz}$), 2.67 (m, 1H), 2.60 (d, 2H, $J = 7\text{Hz}$), 2.08 (m, 1H) 1.70-1.87 (m, 3H), 1.26 (m, 1H). MS (CI), m^+/z : $(M+H)^+ = 176$.

10 Part E: Preparation of N-(3-methoxyphenyl)-N'-[3-[3-(phenyl)methyl]-1-piperidinyl]propyl]urea

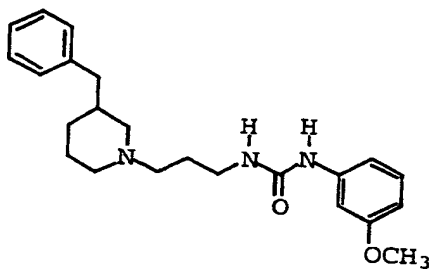

15 The above compound was prepared by the methods similar to the ones employed in Example 1, part C. $^1\text{H NMR}$ (300 MHz, CD_3OD), δ : 7.29-7.13 (m, 4H); 7.07 (d, 1H, $J=9\text{ Hz}$); 7.02 (m, 1H); 6.78 (d, 1H, $J = 9\text{ Hz}$); 6.60 (d, 1H, $J = 9\text{ Hz}$); 3.77 (s, 3H); 3.30 (m, 2H); 2.80 (m, 2H); 20 2.53-2.32 (m, 4H); 1.85-1.55 (m, 7H); 1.44-0.78 (m, 2H). MS (ESI), m^+/z : $(M+H)^+ = 382$.

EXAMPLE 4

Part A: Preparation of a,a'-Dibromo-3-nitro-o-xylene

25

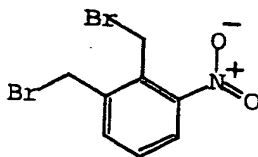

3-Nitro-o-xylene (10.0g, 66.14 mmol, 1.00 eq), N-bromosuccinimide (24.14 g, 135.6 mmol, 2.05 eq), and

benzoyl peroxide (0.8 g, 3.30 mmol, 0.5 eq) were refluxed under N₂ in 200 ml of carbon tetrachloride. The reaction was worked up after two days by washing with 3 x 100 ml of water. The organic phase was dried over sodium sulfate, then the solvent was removed *in vacuo* to obtain an amber oil. The oil was purified by flash chromatography on a 8 cm x 20 cm quartz column, eluting with 7.5% EtOAc/Hexanes to yield 4.46 g of product as a sticky solid. NMR (300 MHz, CDCl₃) δ 7.88 (d, 1H, J=7 Hz), 7.64 (d, 1H, J=7 Hz), 7.48 dd, 1H, J=8 Hz), 4.86 (s, 2H), 4.69(s, 2H).

Part B: Preparation of 1,3-Dihydro-4'-[4-fluorophenylmethyl]-4-nitro-spiro[2H-isoindole-2,1'-piperidinium] bromide

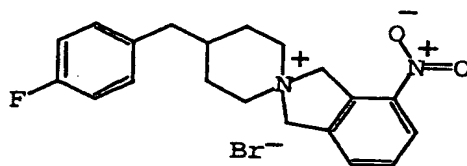

4-Fluorobenzylpiperidine (0.94 g, 4.86 mmol, 1.0 eq), a,a'-dibromo-3-nitro-o-xylene (1.50 g, 4.86 mmol, 1.0 eq), and sodium carbonate (2.57 g, 24.3 mmol, 5.0 eq) were combined in 20 ml THF and stirred at 25° C under N₂, during which time a white solid precipitated from the reaction mixture. The reaction was worked up after 22 hours by filtering the solids and rinsing with THF. The solids were dissolved in methanol and applied to a 3.5 cm x 5 cm quartz column via silica plug. The product was eluted with 20% MeOH/CHCl₃ to yield 1.04 g of a white foam. NMR (300 MHz, CD₃OD) δ 8.27 (d, 1H, J=8 Hz), 7.84 -7.80 (m, 1H), 7.75-7.69 (m, 1H), 7.23 (m, 2H), 7.01 (dd, 2H, J=8 Hz, 8 Hz), 5.38-5.37 (m, 2H), 5.09 (s, 1H), 5.04 (s, 1H), 3.80-3.72 (m, 2H), 3.65-3.54 (m, 2H), 2.71-2.68 (m, 2H), 2.05-1.75 (m, 5H).

Part C: Preparation of 4-Amino-1, 3-dihydro-4'-[4-fluorophenylmethyl]-spiro[2H-isoindole-2,1'-piperidinium] bromide

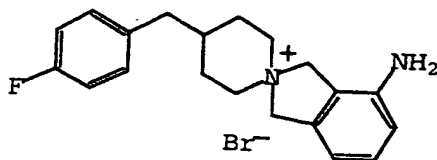

5

1,3-Dihydro-4'-[4-fluorophenylmethyl]-4-nitro-spiro[2H-isoindole-2,1'-piperidinium] bromide (1.03 g, 2.46 mmol, 1.0 eq), zinc (5.32 g, 81.5 mmol, 33.0 eq), and calcium chloride (0.18 g, 1.60 mmol, 0.65 eq) were refluxed under N₂ in 25 ml of a 78% ethanol/water solution. The reaction was worked up after 5 hours by filtering through Celite® and rinsing the cake with methanol. The filtrate was concentrated *in vacuo* to a mixture of water and an amber oil. The mixture was dissolved in 50 ml of 2-propanol, and concentrated *in vacuo* to remove excess water. The resulting yellow foam was dissolved in methanol and applied to a 3.5 cm x 5 cm quartz column via silica plug. The product was eluted with 20% MeOH/CHCl₃ to yield 0.81g of a yellow foam. NMR (300 MHz, DMSO) δ 7.27-7.05 (m, 5H), 6.61-6.53 (m, 2H), 5.43-5.41 (m, 2H), 4.80 (bs, 1H), 4.74 (bs, 2H), 4.63 (bs, 1H), 3.62-3.43 (m, 4H), 2.60 (bd, 2H, J=7 Hz), 1.98-1.59 (m, 5H).

25 Part D: Preparation of N-[1,3-Dihydro-4'-[4-fluorophenylmethyl]spiro[2H-isoindole-2,1'-piperidinium-4-yl]-N'-4-fluorophenylurea bromide

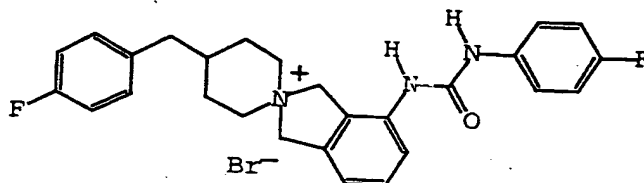

30

4-Amino-1, 3-dihydro-4'-[4-fluorophenylmethyl]-
spiro[2H-isoindole-2, 1'-piperidinium] bromide (0.33 g,
0.84 mmol, 1.0 eq), and 4-fluorophenyl isocyanate (0.23 g,
1.69 mmol, 2.0 eq) were combined in 3 ml DMF and stirred at
5 25. C under N₂ . The reaction was worked up after 22
hours by removing the solvent *in vacuo*, dissolving the
residue in methanol, and applying the mixture to a 3.5 cm x
15 cm quartz column via silica plug. The product was
eluted with 10% MeOH/CHCl₃ to yield 65 mg of a yellow foam.
10 NMR (300 MHz, DMSO) δ 9.18 (s, 1H), 9.00 (s, 1H), 7.49-7.43
(m, 2H), 7.41-7.34 (m, 2H), 7.26-7.21 (m, 2H), 7.17-7.10
(m, 5H), 4.94 (s, 2H), 4.80 (s, 2H), 3.63-3.45 (m, 4H),
2.61 (bd, j=7 Hz), 1.91-1.62 (m, 5H)

15

EXAMPLE 5

Part A. Preparation of 4-benzyl-1-(3-hydroxy-3-phenylprop-
1-yl)piperidine

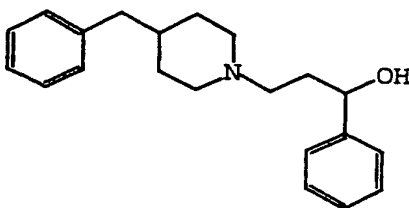

20

To a flame-dried 3-neck flask under a N₂ atmosphere
with a magnetic stirring bar, 4-benzylpiperidine (5.00 mL,
28 mmol, 1 eq), DBU (42 μ L, 0.28 mmol, 0.01 eq), and THF
(100 mL) were added, mixed, and cooled to -15 $^{\circ}$ C using a
25 CCl₄/CO₂(s) bath. Acrolein (1.87 mL, 28 mmol, 1 eq) was
then syringed in slowly during 10 minutes maintaining the
temp. at -15 $^{\circ}$ C. After 0.5 hours at -15 $^{\circ}$ C, phenylmagnesium
chloride (2.0 M, 14.0 mL, 28 mmol, 1 eq) was syringed in
slowly and the contents allowed to slowly warm to room
30 temperature and then stirred for 48 h. The reaction was
worked up by adding 0.1 N NaOH and EtOAc (200 mL each).
The viscous magnesium salts were suction filtered through
fiberglass filter paper. The layers were separated and the

aqueous layer was extracted again with ethyl acetate (2 x 200 mL). The organic layers were combined, washed with brine (1 x 200 mL), dried (MgSO₄) and the solvent removed in vacuo to yield 7.39 g of an amber oil. Flash chromatography in 100% ethyl acetate yielded 2.48 g of an orange oil. NMR (CDCl₃) δ 7.40-7.10 (m, 10H); 4.93 (d of d, 1H, J=3,7 Hz); 3.12-2.96 (m, 2H); 2.68-2.46 (m, 4H); 2.01 (t of d, 1H, J=2, 10 Hz); 1.86-1.26 (m, 8H). ESI MS detects (M+H)⁺ = 310.

10

Part B: Preparation of 4-benzyl-1-(3-azido-3-phenylprop-1-yl)piperidine

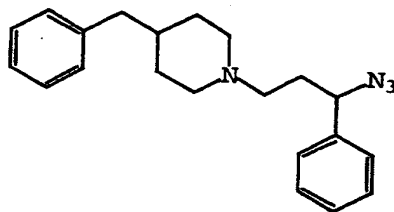

15 The product from part A (209 mg, 0.675 mmol, 1 eq), DBU (123 mg, 0.810 mmol, 1.2 eq), diphenylphosphoryl azide (0.175 mL, 0.810 mmol, 1.2 eq), and toluene (1.0 mL) were mixed and stirred overnight at room temperature under a N₂ atmosphere. The reaction was then worked up by adding
20 ethyl acetate (50 mL), washing with water (3 x 25 mL), followed by washing with brine (1 x 25 mL), drying (MgSO₄) and removing the solvent in vacuo to yield 277 mg of an amber oil. Flash chromatography in 1:1 hexane/ethyl acetate yielded 84 mg of product as an oil. NMR (CDCl₃) δ
25 7.41-7.09 (m, 10 H); 4.56 (t, 1H, J=7 Hz); 3.83 (m, 2H); 2.52 (d, 2H, J=7 Hz); 2.32 (t, 2H, J=7 Hz); 2.30-1.77 (m, 5H); 2.59 (m, 2H); 1.98 (m, 1H); 1.39-1.26 (m, 4H). IR (neat) 2095 cm⁻¹.

30 Part C: Preparation of 4-benzyl-1-(3-amino-3-phenylprop-1-yl)piperidine

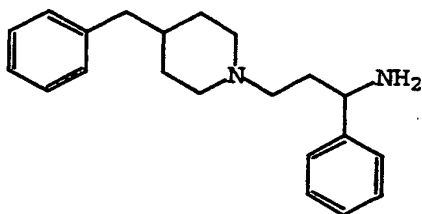

The compound from part B (100 mg), 10% Pd on carbon (120 mg), and methanol (100 mL) were carefully combined in a flask under a N₂ atmosphere. The contents were then submitted to 1 atm of H₂ being delivered via a sparge tube for 0.5 h at room temperature. Filtration of the contents through Celite® and removal of the solvent in vacuo yielded 70 mg of product. NMR (CDCl₃) (key peak only) δ 3.94 (t, 1, J = 7 Hz). NH₄-CI MS detects (M+H)⁺ = 309.

Part D: N-(3-cyanophenyl)-N'-[3-[4-(phenylmethyl)-1-piperidinyl]-1-phenylpropyl]urea

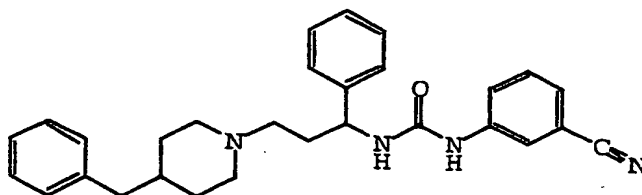

The compound from Part C (57 mg, 0.185 mmol, 1 eq) was mixed and stirred with 3-cyanophenylisocyanate 26.6 mg, 0.185 mmol, 1 eq) in THF (1 mL) overnight at room temperature under a N₂ atmosphere. The solvent was removed in vacuo and the residue flash chromatographed on silica gel in 3:1 to 1:1 hexane/ethyl acetate to 100% ethyl acetate to yield 44.3 mg of a yellow oil. NMR (CDCl₃) δ 7.58 (s, 1H); 7.52 (d, 1H, J = 9 Hz); 7.42 (s, 1H); 7.30-7.17 9m, 8H); 7.12 (m, 3H); 4.82 (m, 1H); 2.97-2.80 (m, 3H); 2.52 (d, 2H, J=7 Hz); 2.35 (m, 2H); 2.05-1.85 (m, 4H); 1.81-1.60 (m, 2H); 1.54 (m, 1H); 1.25 (m, 1H). ESI MS detects (M+H)⁺ = 453.

EXAMPLE 6

Part A: Preparation of 2-benzyloxycarbonylamino-1-phenyl-3-butene.

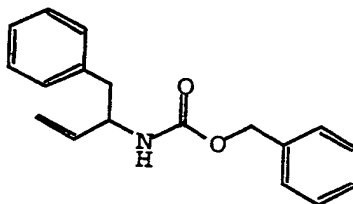

5

To a stirred suspension of methyltriphenylphosphonium bromide (10.72 g, 0.03 moles) in 100 mL of dry tetrahydrofuran at -78°C was added dropwise 1.6M n-butyl lithium (17.5 mL, 0.028 moles), and the mixture was stirred for 0.5 hrs at $-78 \sim -20^{\circ}\text{C}$. Then was added a solution of N-Cbz-phenylalaninal (5.67 g, 0.02 moles) in 50 mL of dry tetrahydrofuran, and the mixture was stirred for 16 hrs at room temperature. After addition of saturated NH_4Cl (50 mL) the mixture was extracted with EtOAc, and the extract was washed with water and brine. It was dried over Na_2SO_4 and evaporated to give an oily residue. The crude product was purified by column chromatography on silica gel with elution by 5:95 EtOAc-hexane to give pure 2-benzyloxycarbonylamino-1-phenyl-3-butene.

15
20

Part B: Preparation of 2-benzyloxycarbonylamino-1-phenyl-3,4-epoxy-butane.

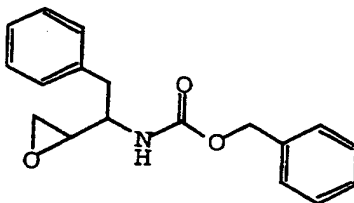

25

To a stirred solution of 2-benzyloxycarbonylamino-1-phenyl-3-butene (1.43 g, 5.08 mmoles) in 20 mL of CH_2Cl_2 was added 3-chloroperoxybenzoic acid (2.19 g, 60%, 7.62 mmoles) in several portions, and the mixture was stirred at

room temperature for 30 hrs. After addition of EtOAc (60 mL), the mixture was washed with saturated NaHCO₃ and brine, and the organic layer was dried over Na₂SO₄. Evaporation of the solvent afforded an oily residue. The
5 crude product was purified by column chromatography on silica gel with elution by 2:8 EtOAc-hexane to give pure 2-benzyloxycarbonylamino-1-phenyl-3,4-epoxy-butane.

Part C: Preparation of 2-benzyloxycarbonylamino-4-[4-(4-fluorophenyl)methyl-1-piperidinyl]-1-phenyl-butan-3-ol.
10

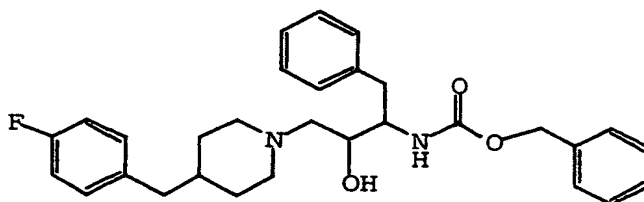

A solution of 4-(4-fluorophenyl)methyl-piperidine
15 (0.515 g, 2.314 mmols) and 2-benzyloxycarbonylamino-1-phenyl-3,4-epoxy-butane (0.688 g, 2.314 mmols) in 5 mL of DMF was stirred for 4 hours at 100°C and cooled to room temperature. After addition of EtOAc (30 mL), the mixture was washed with water (2x) and brine. The organic solution
20 was dried over Na₂SO₄, and evaporated to give an oily residue. It was then purified by passing through a plug of silica gel with elution by EtOAc to give pure product.

Part D: Preparation of 2-amino-4-[4-(4-fluorophenyl)methyl-1-piperidinyl]-1-phenyl-butan-3-ol.
25

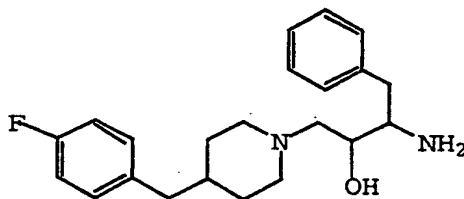

The above product was dissolved in 10 mL of ethanol, and was added 0.1 g of 10% Pd on carbon. The mixture was stirred under hydrogen (1 atm) for 8 hours, and filtered through Celite. Evaporation of the solvent gave the titled product as solid (0.662 g).

Part E: Preparation of N-(3-cyanophenyl)-N'-[1-benzyl-2-hydroxy-3-[4-(4-fluorophenylmethyl)-1-piperidinyl]propyl]urea

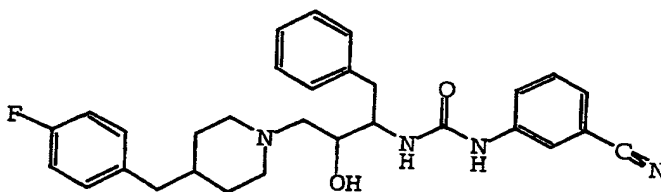

To a solution of 2-amino-4-[4-(4-fluorophenyl)methyl-1-piperidinyl]-1-phenyl-butan-3-ol (50 mg, 0.14 mmoles) in 2.5 mL of dry THF was added 3-cyanophenyl isocyanate (20.2 mg, 0.14 mmoles) and the mixture was stirred for 15 minutes at room temperature. Then the solvent was evaporated off to give an oily residue. It was purified by column chromatography on silica gel with elution by EtOAc to give pure titled compound as an amorphous solid.

MS (ES+) for $C_{30}H_{33}FN_4O_2$: 501.

The following examples were prepared by the procedures previously described in Schemes 1-25 , Examples 1-6 and/or by procedures familiar to one skilled in the art.

TABLE 1*

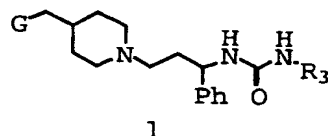
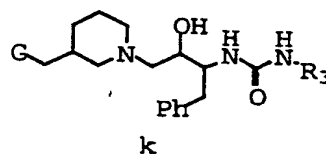
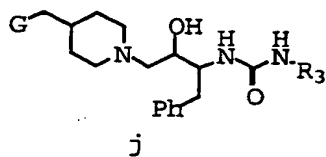
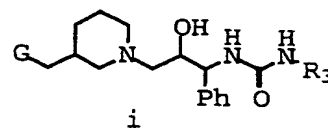
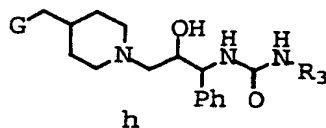
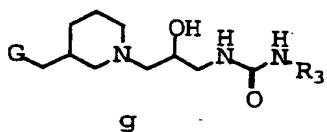
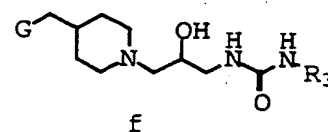
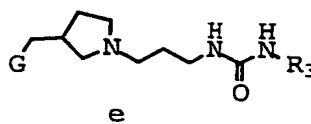
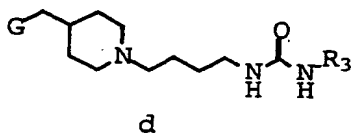
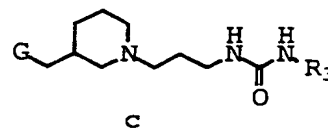
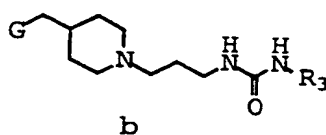
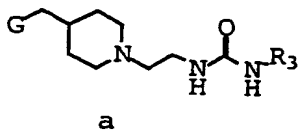

5

Ex #	Core	G	R3	M+1
7	a	Ph	3-CO2Et-Ph	410
8	a	Ph	3-I-Ph	464
9	a	Ph	1-adamantyl	396
10	a	Ph	3-OCH3-Ph	368
11	a	Ph	Ph	338
12	a	Ph	4-F-Ph	356
13	a	Ph	4-CO2Et-Ph	410
14	a	Ph	4-CN-Ph	363
15	b	Ph	1-adamantyl	410
16	b	Ph	2-F-5-CF3-Ph	438
17	b	Ph	2-naphthyl	402
18	b	Ph	2-F-5-NO2-Ph	415
19	b	Ph	4-N(CH3)2-Ph	395
20	b	Ph	2-NO2-Ph	397
21	b	Ph	2-C2H5-Ph	380
22	b	Ph	4-CF4-Ph	420
23	b	Ph	3,5-diCF3-Ph	488
24	b	Ph	3-CO2Et-Ph	424
25	b	Ph	3-CN-Ph	377
26	b	Ph	4-OBn-Ph	458
27	b	Ph	2-Ph-Ph	428
28	b	Ph	2-BrPh	431
29	b	Ph	4-I-Ph	478
30	b	Ph	3-I-Ph	478
31	b	Ph	4-OEt-Ph	396
32	b	Ph	4-nBu-Ph	408
33	b	Ph	4-nBuO-Ph	424
34	b	Ph	CH(Bn)CO2Et	452

35	b	Ph	CH(iPr)CO2Et	404
36	b	Ph	nC8H17	388
37	b	Ph	3-OCH3-Ph	382
38	b	Ph	Ph	352
39	b	Ph	4-CO2Et-Ph	424
40	b	Ph	4-F-Ph	370
41	b	Ph	2-Phenyl- cyclopropyl	392
42	b	Ph	2-OCH3-Ph	382
43	b	Ph	4-OCH3-Ph	382
44	b	4-F-Ph	3-CN-Ph	395
45	b	4-F-Ph	4-F-Ph	388
46	b	4-F-Ph	4-CO2Et-Ph	442
47	b	3,4-OCH2O-Ph	3-CN-Ph	421
48	b	4-F-Ph	3-OCH3-Ph	400
49	b	3,4-OCH2O-Ph	3-CO2Et-Ph	468
50	b	3,4-OCH2O-Ph	3-OCH3-Ph	426
51	b	4-OCH3-Ph	3-OCH3-Ph	412
52	b	4-OCH3-Ph	4-F-Ph	400
53	b	Ph	4-CN-Ph	377
54	b	3,4-OCH2O-Ph	4-F-Ph	414
55	b	4-OCH3-Ph	4-CN-Ph	407
56	b	2,4-diF-Ph	4-F-Ph	406
57	b	2,4-diF-Ph	3-OCH3-Ph	418
58	b	2,4-diF-Ph	3-CN-Ph	413
59	b	3-CF3-Ph	4-F-Ph	438
60	b	3-CF3-Ph	3-OCH3-Ph	450
61	b	4-F-Ph	CH2Ph	384
62	b	4-F-Ph	CH2CH2Ph	398
63	b	4-F-Ph	2-F-Ph	388
64	b	4-F-Ph	3-F-Ph	388
65	b	4-F-Ph	cyclohexyl	376
66	b	4-F-Ph	iPr	336
67	b	4-F-Ph	2-phenyl- cyclopropyl	410
68	b	4-CF3-Ph	3-CN-Ph	445
69	b	3-CF3-Ph	3-CN-Ph	445
70	b	4-CH3-Ph	3-OCH3-Ph	396
71	b	4-CH3-Ph	3-CN-Ph	391
72	b	4-Cl-Ph	3-CN-Ph	411
73	b	4-CF3-Ph	4-CO2Et-Ph	492
74	b	3-OCH3-Ph	3-OCH3-Ph	412
75	b	3-OCH3-Ph	3-CN-Ph	407
76	b	4-CO2CH3-Ph	3-OCH3-Ph	440
77	b	4-CO2CH3-Ph	3-CN-Ph	435
78	b	4-CO2CH3-Ph	4-F-Ph	428
79	b	4-CO2CH3-Ph	4-CO2CH3-Ph	482
80	b	4-CF3-Ph	4-F-Ph	438
81	b	4-CF3-Ph	3-OCH3-Ph	450
82	b	3-OCH3-Ph	4-F-Ph	400
83	b	3-OCH3-Ph	4-CO2Et-Ph	454
84	b	2-F-Ph	3-CN-Ph	395
85	b	3-OCH3-Ph	3-F-Ph	400

86	b	2-F-Ph	3-OCH3-Ph	400
87	b	3-OCH3-Ph	3-CO2Et-Ph	454
88	b	2-F-Ph	3-F-Ph	388
89	b	2-F-Ph	4-F-Ph	388
90	b	2-F-Ph	3-CO2Et-Ph	442
91	b	3-F-Ph	3-CN-Ph	395
92	b	3,4-diF-Ph	3-CN-Ph	413
93	b	3,4-diF-Ph	3-OCH3-Ph	418
94	b	4-Cl-Ph	4-F-Ph	404
95	b	4-Cl-Ph	3-OCH3-Ph	416
96	b	2-F-Ph	4-CO2Et-Ph	442
97	b	3-F-Ph	3-OCH3-Ph	400
98	b	3-F-Ph	4-F-Ph	388
99	b	3-F-Ph	4-CO2Et-Ph	442
100	b	3,4-diF-Ph	4-F-Ph	406
101	b	3-Cl-Ph	3-CN-Ph	411
102	b	4-F-Ph	3-COCH3-Ph	412
103	b	3,5-diF-Ph	3-CN-Ph	413
104	b	3,5-diF-Ph	3-OCH3-Ph	418
105	b	4-F-Ph	4-COCH3-Ph	412
106	b	1-naphthyl	3-CN-Ph	427
107	b	1-naphthyl	4-F-Ph	420
108	b	1-naphthyl	3-OCH3-Ph	432
109	b	3-CH3-Ph	3-CN-Ph	391
110	b	3-CH3-Ph	4-F-Ph	384
111	b	3-CH3-Ph	3-OCH3-Ph	396
112	b	4-F-Ph	2-iPr-Ph	412
113	b	4-F-Ph	2-CF3-Ph	438
114	b	4-F-Ph	3-Cl-Ph	404
115	b	4-F-Ph	3-CF3-Ph	438
116	b	4-F-Ph	4-Ph-Ph	446
117	b	4-F-Ph	2-Cl-Ph	404
118	b	4-F-Ph	2,4-diF-Ph	406
119	c	Ph	3-CO2Et-Ph	424
120	c	Ph	3-CN-Ph	377
121	c	Ph	4-F-Ph	370
122	c	Ph	Ph	352
123	c	Ph	1-adamantyl	410
124	c	Ph	4-CO2Et-Ph	424
125	c	4-F-Ph	Ph	370
126	c	4-F-Ph	3-CN-Ph	395
127	c	4-F-Ph	1-adamantyl	428
128	c	4-F-Ph	3-OCH3-Ph	400
129	c	4-F-Ph	3-CO2Et-Ph	442
130	c	4-F-Ph	4-F-Ph	388
130a	c	4-F-Ph	3-COCH3-Ph	412
131	c	2-F-Ph	Ph	370
132	c	2-F-Ph	3-CN-Ph	395
133	c	2-F-Ph	3-OCH3-Ph	400
134	c	2-F-Ph	4-F-Ph	388
135	c	3-F-Ph	3-OCH3-Ph	400
136	c	3-F-Ph	3-CN-Ph	395
137	c	2,4-diF-Ph	3-CN-Ph	413

138	c	2,4-diF-Ph	3-OCH3-Ph	418
139	c	2,4-diF-Ph	Ph	388
140	c	2,4-diF-Ph	4-F-Ph	406
141	c	2,4-diF-Ph	3-COCH3-Ph	430
142	d	Ph	3-CN-Ph	391
143	d	Ph	3-CO2Et-Ph	438
144	d	Ph	3-I-Ph	492
145	d	Ph	4-OCH2Ph-Ph	472
146	d	Ph	1-adamantyl	424
147	d	Ph	3-OCH3-Ph	396
148	d	Ph	Ph	366
149	d	Ph	4-F-Ph	384
150	d	Ph	4-CO2Et-Ph	438
151	d	Ph	4-CN-Ph	391
152	e	4-F-Ph	Ph	356
153	e	4-F-Ph	3-CN-Ph	381
154	e	4-F-Ph	3-OCH3-Ph	386
155	e	4-F-Ph	4-F-Ph	374
156	e	4-F-Ph	3-CO2Et-Ph	428
157	e	4-F-Ph	4-CO2Et-Ph	428
158	e	4-F-Ph	1-adamantyl	414
159	f	4-F-Ph	3-CN-Ph	411
160	f	4-F-Ph	3-OCH3-Ph	416
161	j	Ph	Ph	458
162	j	Ph	3-CN-Ph	483
163	j	Ph	3-OCH3-Ph	488
164	j	4-F-Ph	3-OCH3-Ph	506
165	j	4-F-Ph	4-F-Ph	494
166	j	4-F-Ph	1-adamantyl	534
167	l	Ph	3-OCH3-Ph	458
168	l	Ph	1-adamantyl	486
169	c	imidazol-1-yl	3-OCH3-Ph	372

* All stereocenters are (+/-) unless otherwise indicated

TABLE 2**

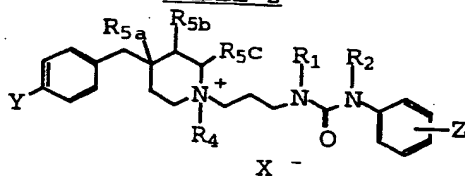

m

5

Ex #	Y	Z	R4	X	R5a	R5b	R5c	R1	R2
170	H	H	-	-	H	H	H	H	Ph
171	H	H	-	-	H	H	H	H	CH3
172	H	3-OCH3	CH2Ph	Br	H	H	H	H	H
173	H	3-CN	-	-	CO2E	H	H	H	H
174	H	3-OCH3	CH3	I	H	H	H	H	H
175	H	3-CN	CH3	I	H	H	H	H	H

176	H	3-CN	CH2Ph	Br	H	H	H	H	H
177	H	3-CN	-	-	H	H	H	CH2P h	H
178	H	3-CN	-	-	H	H	H	Et	H
179	H	4-F	CH3	I	H	H	H	H	H
180	H	4-F	CH2Ph	Br	H	H	H	H	H
181	H	4-F	CH2CO2CH 3	Br	H	H	H	H	H
182	H	3-CN	CH2CN	Br	H	H	H	H	H
183	H	3-CN	CH2COPh	Br	H	H	H	H	H
184	H	2-OCH3	CH3	I	H	H	H	H	H
185	H	4-OCH3	CH3	I	H	H	H	H	H
186	F	3-CN	CH3	I	H	H	H	H	H
187	H	3-CN	-	-	H	H	H		
188	H	3-OCH3	O	-	H	H	H	H	H
189	H	3-OCH3	-	-				CH2P h	
190	F	3-CN	CH3	I	H	H	H	H	H
191	F	3- COCH3	-	-	H	CH2P h	H	H	H
192	F	4-F-Ph	-	-	H	CH2P h	H	H	H
193	F	3-OCH3	-	-	H	CH2P h	H	H	H
194	H	3-OCH3	-	-	H	H	H	CH2P h	H
195	H	3-CN	-	-	H	H	H	CH2P h	H

**All compounds are amorphous unless otherwise indicated.

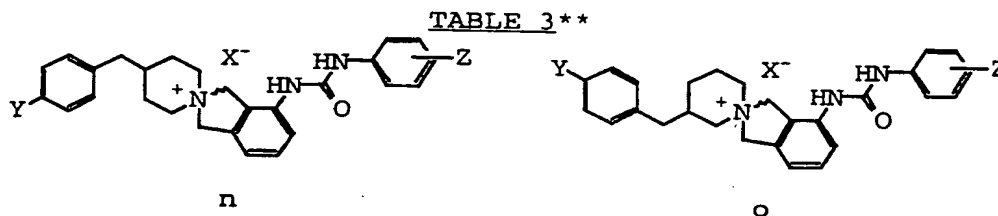

5

Ex #	Core	Y	Z	X
196	n	H	3-CN	Br
197	n	H	3-CN	Br
198	n	H	4-F	Br
199	n	H	4-F	Br
200	n	F	3-CN	Br
201	n	F	3-CN	Br
202	n	F	3-OCH3	Br
203	n	F	3-OCH3	Br
204	o	F	4-F	Br
205	o	F	4-F	Br
206	o	F	3-OCH3	Br
207	o	F	3-OCH3	Br

208	o	F	3-CN	
209	o	F	3-CN	Br
				Br

**All compounds are amorphous unless otherwise indicated.

- 5 The compounds of the present invention in which E contains ring A can be prepared in a number of ways well known to one skilled in the art of organic synthesis. As shown in Scheme 26, 4-benzyl piperidine is N-alkylated with an alkylating agent, such as 165 (2-nitro-benzyl bromide (X = Br, R¹⁴ = H), Scheme 26) to give the N-benzyl compound 166. The nitro group of 166 is then reduced using catalytic hydrogenation to give the corresponding aniline 167. The aniline can be converted to the carbamate 168 using chloro-phenyl formate. The carbamate 168 can then be reacted with various amines to give the urea 169. Alternatively, the aniline 167 can be reacted with the appropriate isocyanates to give the urea 169 directly. The saturated ring analogs can also be used. For example, 4-benzyl piperidine can be alkylated with the urea mesylate 185 (Scheme 30) to give corresponding cyclohexyl derivative 186.
- As shown in Scheme 27, 4-benzyl piperidine can also be N-alkylated with the phenacyl bromide 170 to give the nitro ketone 171. The nitro group of 171 is then reduced using catalytic hydrogenation to give the corresponding aniline 172. The aniline 172 can be reacted with the appropriate isocyanates to give the ketone urea 173. The ketone of 173 can be reduced with NaBH₄ to give the alcohol 174.
- Alternatively, the epoxide 175 (R¹⁴ = H) can be opened with the 4-benzyl piperidine to give the corresponding nitro benzyl alcohol which is hydrogenated to give the aniline alcohol 176. The aniline 176 may be treated with various isocyanates to give the urea alcohols 174.
- The 4-benzyl piperidine can also be N-alkylated with 3-cyanobenzyl bromide (177, Scheme 28) to give the cyano analog 178. The cyano group is reduced using Raney nickel

to give the corresponding benzyl amine 179. Treatment of 179 with isocyanates gives the urea 180.

As shown in Scheme 29, treatment of 3-cyano aniline with phenylisocyanate gives the urea 182. The cyano group of 182 is converted to the imidate 183 by HCl/ethanol. Reaction with 4-benzyl piperidine in ethanol then gives the amidine 184.

The saturated ring analogs can also be synthesized using analogous procedures as outlined in Schemes 30 and 31. For example, 4-benzyl piperidine can be alkylated with the urea mesylate 185 (Scheme 29) to give corresponding cyclohexyl derivative 186. Alternatively, starting with the enantiomerically pure amino alcohol 187 [*J. Am. Chem. Soc.* **1996**, *118*, 5502-5503 and references therein] one can protect the nitrogen to give the N-Cbz alcohol 188. Swern oxidation of the alcohol gives the aldehyde 189. Reductive amination with piperidine analogs gives the cyclohexyl methyl-1-piperidinyl analogue 190. The Cbz group is removed by catalytic hydrogenation to give the free amine 191, which is treated with a phenylisocyanate to give the desired urea analogue 192. Several examples using these synthetic methods are listed in Table 3a and Table 3.1.

SCHEME 26

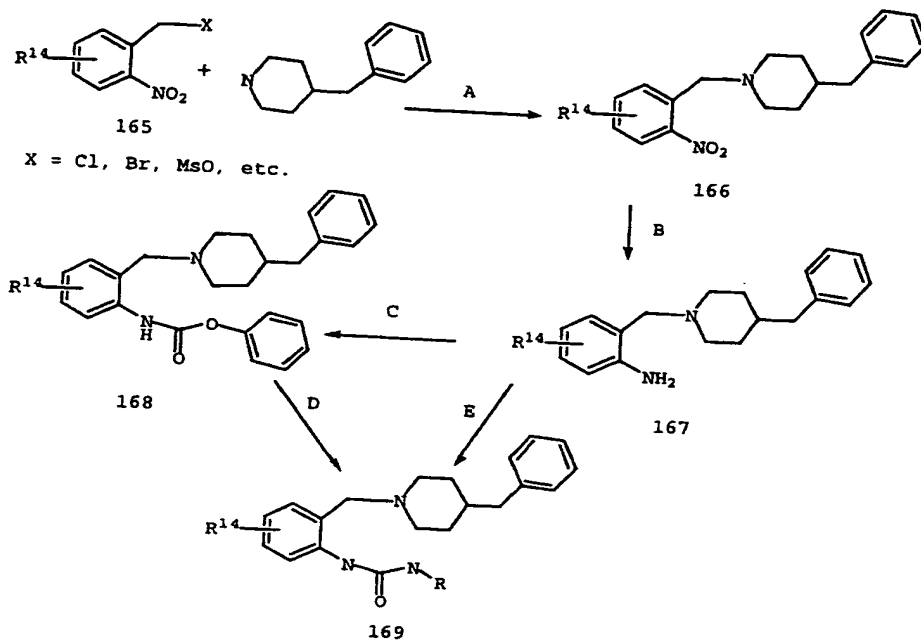

A: DMF/ K_2CO_3 /RT or THF/RT. B: 10%Pd/C, H_2 50 psi.
 C: THF/ Et_3N /chlorophenylformate. D: NHR/DMF/50°C.
 E: R-N=C=O/THF

SCHEME 27

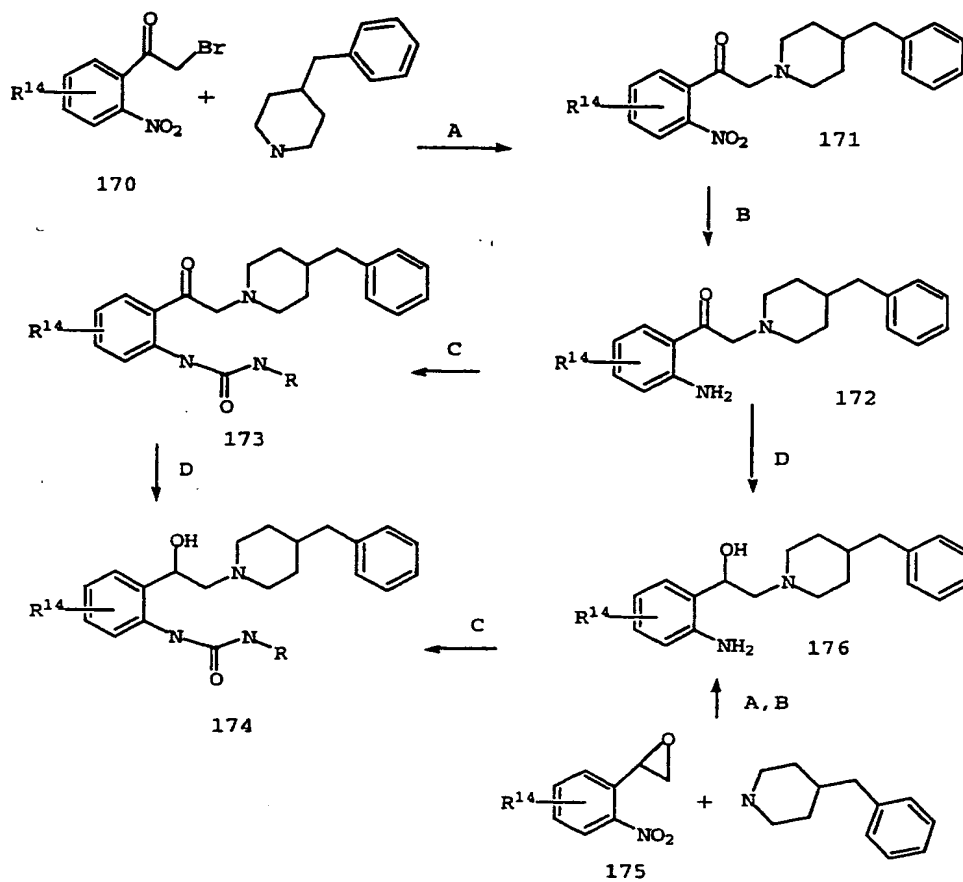

A: DMF/K₂CO₃/RT or DMF/50°C. B: 10%Pd/C, H₂ 50 psi. C: R-N=C=O/THF. D: NaBH₄/MeOH/RT

SCHEME 28

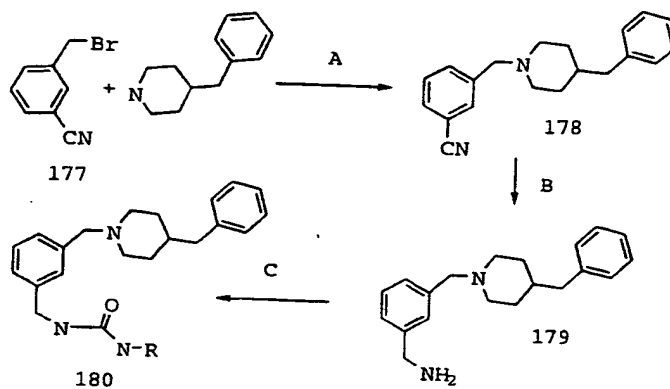

A: DMF/K₂CO₃/RT B: Raney nickel, H₂ 50 psi. C: R-N=C=O/THF.

SCHEME 29

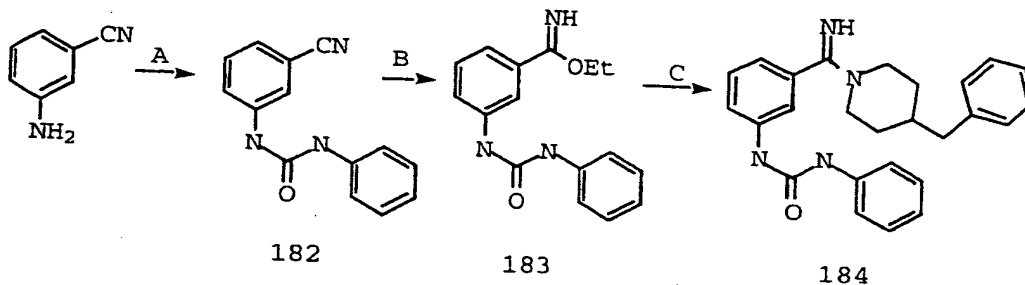

A: R-N=C=O/THF. B: EtOH/HCl/RT
C: 4-benzylpiperidine/EtOH/RT

5

SCHEME 30

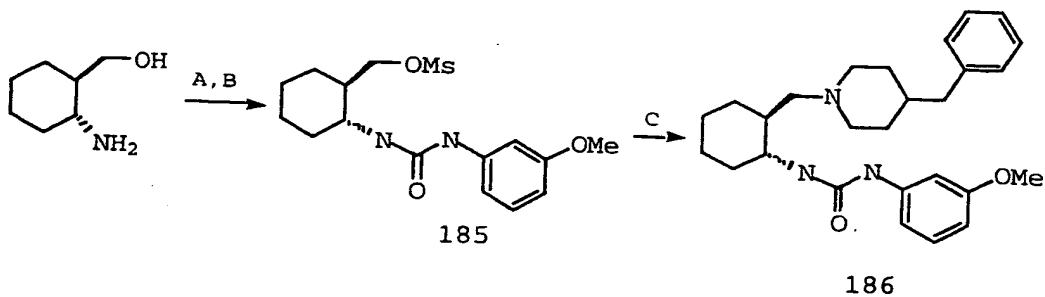

A: R-N=C=O/DMF. B: Ms-Cl/THF
C: 4-benzylpiperidine/DMF/RT

SCHEME 31

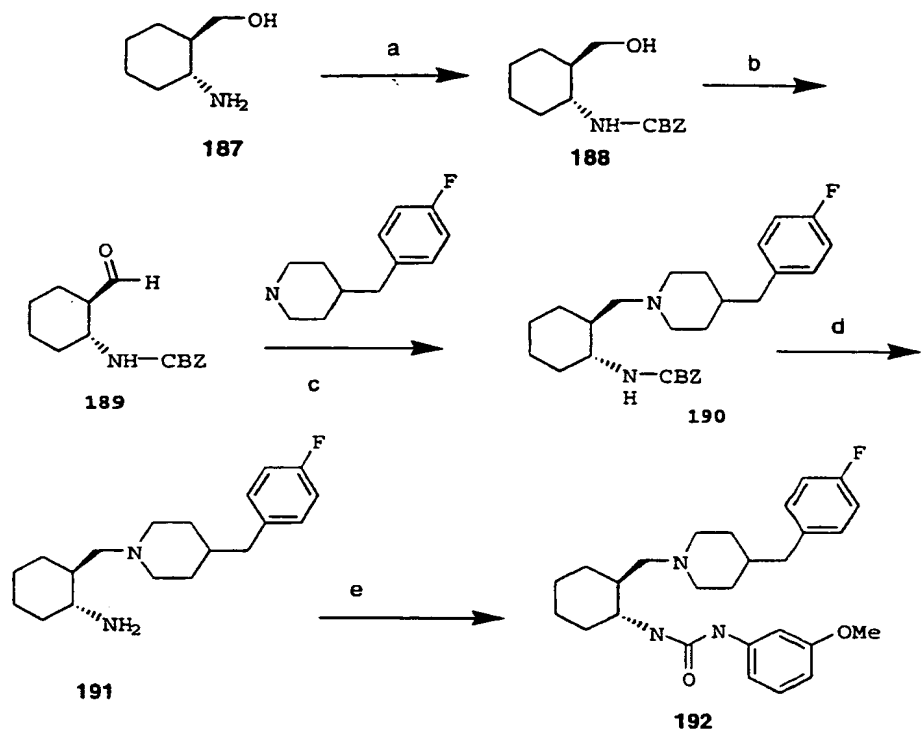

a: Benzyl chloroformate/ $\text{Na}_2\text{CO}_3/\text{CH}_2\text{Cl}_2$. b: Swern Ox.
 c: $\text{NaBH}(\text{OAc})_3$ d: $\text{H}_2/10\% \text{ Pd/C}$ e: R-N=C=O/THF .

SCHEME 31a

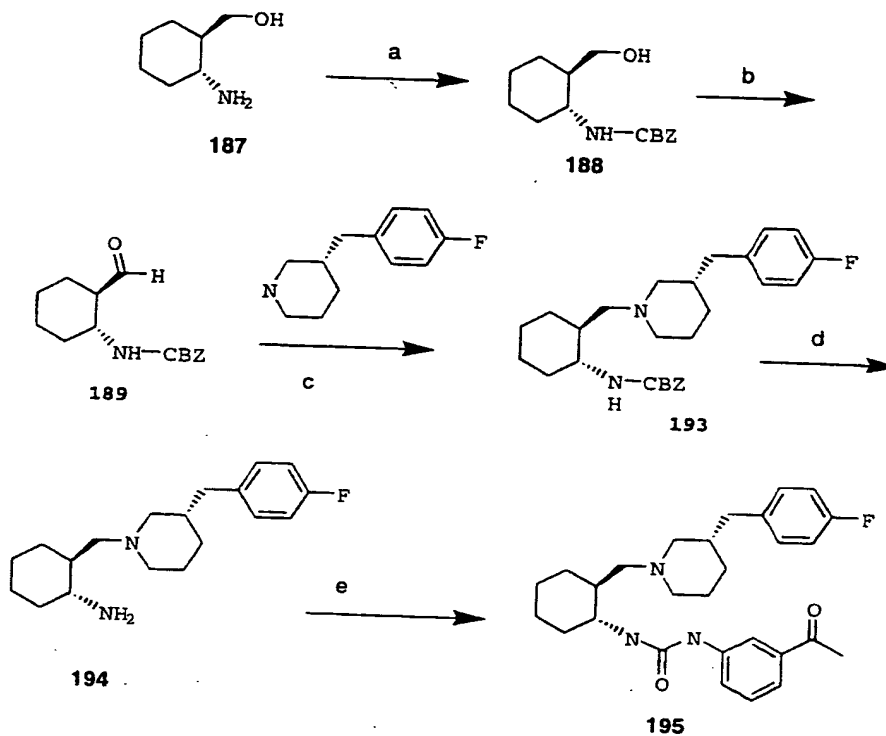

a: Benzyl chloroformate/ $\text{Na}_2\text{CO}_3/\text{CH}_2\text{Cl}_2$. b: Swern Ox.
 c: $\text{NaBH}(\text{OAc})_3$ d: $\text{H}_2/10\% \text{Pd/C}$ e: R-N=C=O/THF .

The following examples were synthesized using the methods outlined in Schemes 26-31a. These examples are meant to be illustrative of the present invention, and are not to be limiting thereof.

EXAMPLE 218

N-[1-(phenylmethyl)4-piperidinyl]-*N'*-[2-[[4-(phenylmethyl)-1-piperidinyl]-methyl]phenyl]urea.

A solution of 4-benzylpiperidine (1.75 g, 10 mmol) in 25 mL of DMF was treated with 2-nitrobenzyl bromide (2.16 g, 10 mmol) and K_2CO_3 (1.38 g, 10 mmol) and the reaction

mixture stirred at room temperature for 2 h. The mixture was diluted with water and extracted into ethyl acetate. The organic extracts were washed successively with water and brine, and the organic solvent removed under vacuum on a rotary evaporator to give 166 (Scheme 26, R¹⁴ = H) as a yellow oil.

The oil was re-dissolved in ethyl acetate (50 ml) and treated with 10% Pd/C and hydrogenated at 50 psi hydrogen at room temperature for 40 min. The solution was then filtered and the solvent removed under vacuum to give the aniline 167 as a white solid. The aniline was purified by chromatography (MPLC, 40% ethyl acetate/ hexane; silica gel) to give 2.0 g of aniline 167 as a white solid.

A solution of aniline 167 (1.2 g, 4.3 mmol) in THF was treated with Et₃N (1.0 g, 10 mmol) and cooled in an ice bath to 0 °C. Chlorophenyl formate (0.71 g, 4.5 mmol) was added to the mixture and stirred for 1 h. The mixture was diluted with water and extracted into ethyl acetate. The extracts were washed with water and brine, and the solvent removed under vacuum to give the phenyl carbamate 168 as an off-white solid. The crude product was used without further purification.

A solution of phenylcarbamate 168 (0.2 g, 0.5 mmol) in DMF is treated with 4-amino-1-benzylpiperidine (95 mg, 0.5 mmol) and K₂CO₃ (138 mg, 1 mmol) and the mixture was heated at 50 °C for 2 h. The mixture was diluted with water and extracted into ethyl acetate. The extracts were washed with water and brine, and the solvent removed under vacuum. The residue was purified by chromatography (MPLC, 0-25 % MeOH/ethyl acetate; silica gel) to give 200 mg of the target compound as a white solid. esi ms: (M+H)⁺ = 497.

EXAMPLE 219

N-(2,5-difluorophenyl)-*N'*-[2-[[4-(phenylmethyl)-1-piperidinyl]-methyl]phenyl]urea.

A solution of aniline 167 (Scheme 26; (R¹⁴ = H)) (140 mg, 0.5 mmol) in THF is treated with 2,5-difluoroisocyanate (80 mg, 0.5 mmol) at room temperature for 1 h. The solvent is removed under vacuum and the residue was purified, by chromatography (MPLC, 20% EtOAc/Hexane, silica gel) to give the desired urea as a white solid. esi ms: (M+H)⁺ = 436.

EXAMPLE 220

N-(2,5-difluorophenyl)-*N'*-[[3-[[4-(phenylmethyl)-1-piperidinyl]methyl]phenyl]methyl]urea.

A solution of 4-benzylpiperidine (1.75 g, 10 mmol) in 25 mL of DMF was treated with 3-cyanobenzyl bromide 177 (1.96 g, 10 mmol) and K₂CO₃ (2.76 g, 20 mmol) and the reaction mixture stirred at room temperature for 2 h. The mixture was diluted with water and extracted into ethyl acetate. The organic extracts were washed successively with water and brine, and the organic solvent removed under vacuum on a rotary evaporator to give 178 (Scheme 28) as a yellow oil.

To a suspension of Raney nickel (2.0 g) in EtOH (saturated with NH_{3(gas)}) was added crude 178 (Scheme 28) (1.45 g, 5 mmol) and hydrogenated at 50 psi for 3 days. The solution was then filtered and the solvent removed under vacuum to give the amine 179 as a yellow oil. A solution of amine 179 (200 mg, 0.68 mmol) in THF is treated with 2,5-difluoroisocyanate (115 mg, 0.74 mmol) at room temperature for 1 hour. The solvent is removed under vacuum and the residue is washed with 1 NaOH and water to give the desired urea as a white solid. esi ms: (M+H)⁺ = 450.

EXAMPLE 221

N-(2,5-difluorophenyl)-*N'*-[2-[[4-(phenylmethyl)-1-piperidinyl]acetyl]phenyl]urea

To an ice cold solution of 2-bromo-2'-nitro-acetophenone 170 (2.4 g, 10 mmol) in DMF is added 4-benzylpiperidine (1.75 g, 10 mmol) and stirred for 30 min. The solution was poured into a mixture of K₂CO₃ (1.38 g, 10
5 mmol) in water/ice and extracted into ethyl acetate. The ethyl acetate extract was washed several times with water. The resultant ethyl acetate solution of crude nitroketone 171 is treated with 10% Pd/C and hydrogenated at 50 psi hydrogen at room temperature for 40 min. The solution was
10 then filter, the solvent removed under vacuum, and the residue purified by chromatography (MPLC, 30% ethyl acetate/hexane; silica gel) to give 1.8 g of aniline 172 as a tan/brown solid.

A solution of aniline 172 (Scheme 27) (310 mg, 1.0
15 mmol) in THF is treated with 2,5-difluoroisocyanate (160 mg, 1.0 mmol) at room temperature for 1 h. The solvent is removed under vacuum and the residue is purified by chromatography (MPLC, 20% EtOAc/Hexane, silica gel) to give 420 mg of the desired urea-ketone 173 as a white solid. esi
20 ms: (M+H)⁺ = 464.

EXAMPLE 222

N-(2,5-difluorophenyl)-*N'*-[2-[2-[4-(phenylmethyl)-1-piperidinyl]-1-hydroxyethyl]phenyl]urea
25

A solution of the urea-ketone 173 (260 mg, 0.56 mmol) in MeOH is treated with NaBH₄ (400 mg, 11 mmol) at room temp for 1 hour. The solvent is removed under vacuum and the residue is treated with 1 N NaOH and extracted into EtOAc.
30 The extracts are washed with water, brine and the solvent removed under vacuum to give the desired alcohol 174 as a white solid. esi ms: (M+H)⁺ = 466.

EXAMPLE 223

N-[3-[imino-[4-(phenylmethyl)-1-piperidinyl]methyl]phenyl]-*N'*-phenylurea
35

A solution of 3-cyanoaniline (3.54 g, 30 mmol) in THF is treated with phenylisocyanate (3.58 g, 30 mmol) at room temperature for 1 h. The solvent is removed under vacuum and the residue is titrated with hexane to give 7 grams of urea 182 (Scheme 29) as a white solid. Urea 182 (1.0 g, 4.2 mmol) is dissolved in EtOH, cooled in an ice bath while HCl is bubbled-in for 20 min. The solution is left standing at room temperature for 24 h. The solvent is removed under vacuum to give 1.1 g of the imidate 183 as a white solid. The crude imidate (0.5 g, 1.8 mmol) was dissolved in EtOH and treated with 4-benzyl-piperidine (1.8 g, 10 mmol) at room temperature for 2 days. The solvent was removed under vacuum and the residue was purified by chromatography (MPLC, 0 to 30% MeOH/EtOAc, silica gel) to give 200 mg of the desired amidine 184 (Scheme 29) as a white solid. esi ms: (M+H)⁺ = 413.

EXAMPLE 416

N-(3-methoxyphenyl)-N'-[(1R,2S)-2-[[4-phenylmethyl]piperidinyl)methyl]cyclohexyl]urea.

Step a: To a solution of (R,R) amino alcohol 187 [*J. Am. Chem. Soc.* 1996, 118, 5502-5503 and references therein] (1.9 g, 14.7 mmol) in CH₂Cl₂ (50 mL) is added 50 ml of an aqueous solution of Na₂CO₃ (2.4 g, 28.9 mmol). While stirring, benzyl chloroformate (2.51 g, 14.7 mmol) is added and the mixture is stirred at room temperature for 1 h. The organic layer is separated and washed with water and brine. The solution is concentrated on a rotary evaporator and the residue is chromatographed on silica gel (30% ethyl acetate/hexane) to give 3.1 g (12 mmol) of 188 as a white solid. ¹H NMR (300 MHz, CDCl₃) δ 7.40-7.29 (m, 5 H), 5.11 (s, 2 H), 4.71 (bd, 1 H), 3.76-3.71 (m, 1 H), 3.53-3.28 (m, 3 H), 2.00-1.95 (m, 1 H), 1.90-1.09 (m, 8 H). MS AP⁺ (M+H)⁺ = 264.3 (100 %).

Step b: A solution of DMSO (2.52 g, 30 mmol) in CH_2Cl_2 (50 mL) is cooled to -78°C . To this solution is added dropwise oxalyl chloride (1.81 g, 14 mmol) and the resulting solution is stirred for an additional 10 min. Then a
5 solution of alcohol 188 (2.5 g, 9.5 mmol) in CH_2Cl_2 (70 ml) is added via an addition funnel and stirred for 10 min. Then Et₃N (5.0 g, 50 mmol) is added and the solution is allowed to warm to room temperature. The solution is diluted with water and the organic layer washed with water,
10 1 N HCl, and brine. The organic layer is dried over Na_2SO_4 , filtered, and concentrated to give 2.5 g (9.5 mmol) of the aldehyde 189 as a white solid. ¹H NMR (300 MHz, $-\text{CDCl}_3$) δ 9.59 (d, 3.6 Hz, 1 H), 7.38-7.28 (m, 5 H), 5.07 (m, 2 H), 4.69 (m, 1 H), 3.84 (m, 21 H), 2.19-2.11 (m, 1 H), 2.09-2.01
15 (m, 1 H), 1.86-1.75 (m, 3 H), 1.54-1.17 (m, 4 H).

Step c: A solution of aldehyde 189 (2.0 g, 7.7 mmol), 4-(4-fluorophenylmethyl)piperidine hydrochloride (1.8 g, 7.8 mmol) in dichloroethane (80 ml) was treated with
20 $\text{Na}(\text{OAc})_2\text{BH}$ (3.23 g, 15 mmol) and 1 ml AcOH and stirred overnight at room temperature. The resulting solution was diluted with methylene chloride and washed with 1 n NaOH, water, and brine. The organic solvents were removed under vacuum and the residue chromatographed on silica gel (50%
25 EtOAc/hex - 100% EtOAc) to give 3.0 g (6.8 mmol) of 190 as an oil.

Step d: A solution of 190 (3.0 g, 6.8 mmol) in MeOH was treated with 1.5 g of 10% Pd/C and hydrogenated at 50
30 psi overnight in a Parr apparatus. The mixture was filtered and the filtrate concentrated on a rotary evaporator to give 1.8 g (5.9 mmol) of the amine 191 as an oil.

Step e: A solution of amine 191 (200 mg, 0.67 mmol) in
35 THF is treated with 3-methoxyphenyl isocyanate (110 mg, 0.75 mmol) and the mixture is stirred for 30 min. The solvent is removed on a rotary evaporator and the residue is chromatographed on silica gel (50% EtOAc/hex - 100%

EtOAc) to give 250 mg of urea 192 as a solid. MS esi:
(M+H)⁺ = 454.4 (100%), HRMS (M+H)⁺ = 454.2875.

EXAMPLE 415

5 N-(3-acetylphenyl)-N'-[(1R,2S)-2-[[[(3S)-3-(4-
fluorophenyl)methyl]piperidinyl]methyl]cyclohexyl]urea.

Step a: To a solution of (R,R) amino alcohol 187 [*J. Org.*
Chem. **1996**, *61*, 5557-5563; *J. Am. Chem. Soc.* **1996**, *118*,
10 5502-5503] (9.5 g, 73.8 mmol) in CH₂Cl₂ (200 mL) is added
200 ml of an aqueous solution of Na₂CO₃ (15 g, 141 mmol).
While stirring, benzyl chloroformate (12.6 g, 73.8 mmol) is
added slowly and the mixture is stirred at room temperature
for 1 h. The organic layer is separated and washed with
15 water and brine. The organic solvent is removed on a rotary
evaporator to give a white solid. The solid is
recrystallized from hexane to give 16.3 g (62 mmol) of the
alcohol 188 (Scheme 31a) as a white solid. ¹H NMR (300 MHz,
CDCl₃) δ 7.40-7.29 (m, 5 H), 5.11 (s, 2 H), 4.71 (bd, 1 H),
20 3.76-3.71 (m, 1 H), 3.53-3.28 (m, 3 H), 2.00-1.95 (m, 1 H),
1.90-1.09 (m, 8 H). MS AP⁺ (M+H)⁺ = 264.3 (100 %)

Step b: A solution of DMSO (36 g, 430 mmol) in CH₂Cl₂ (200
mL) is cooled to -78°C. To this solution is added drop-wise
25 oxalyl chloride (27.41 g, 216 mmol) and the resulting
solution is stirred for an additional 10 min. A solution of
alcohol 188 (38 g, 144 mmol) in CH₂Cl₂ (150 ml) is added via
an addition funnel and stirred for 10 min. Then, Et₃N (58
g, 570 mmol) is added and the solution is stirred for 20
30 min and the ice bath removed and stirred for an additional
30 min. The solution is diluted with water and the organic
layer separated and washed with water, 1 N HCl, and brine.
The organic layer is dried over Na₂SO₄, filtered, and
concentrated to give 38 g of aldehyde 189 as a white solid.
35 The solid is recrystallized from hexane to give 19.7 grams
of a first crop of aldehyde 189 as white needles. A second
crop gave an additional 11 grams. ¹H NMR (300 MHz, CDCl₃) δ

9.59 (d, 3.6 Hz, 1 H), 7.38-7.28 (m, 5 H), 5.07 (m, 2 H), 4.69 (m, 1 H), 3.84 (m, 21 H), 2.19-2.11 (m, 1 H), 2.09-2.01 (m, 1 H), 1.86-1.75 (m, 3 H), 1.54-1.17 (m, 4 H).

5 Step c: A solution of aldehyde 189 (19.6 g, 75 mmol) and (3S)-3-(4-fluorophenylmethyl)piperidine (14.5 g, 75 mmol) in dichloroethane (400 ml) was treated with Na(OAc)₂BH (32 g, 152 mmol) and stirred overnight at room temperature. The
10 resulting solution was poured slowly into a stirred mixture of ice/water/1 N NaOH and stirred for 20 min. The organic layer was separated and washed water, and brine. The solution was dried over MgSO₄ and the organic solvent was removed under vacuum and the residue chromatographed on basic alumina (50% EtOAc/hexane) to give 32.1 g (73 mmol)
15 of amine 193 as mixture of (15%)cis and trans isomers. ¹H NMR (300 MHz, CDCl₃) δ 7.79 (bs, 1 H), 7.38-7.29 (m, 5 H), 6.95-6.84 (m, 4 H), 5.08 (m, 2 H), 3.71 (m, 1 H, cis isomer), 3.06 (m, 1 H, trans isomer), 2.80 (m, 1 H), 2.55-2.36 (m, 2 H), 2.30 (dd, J = 9 Hz, J = 13 Hz, 1 H, trans
20 isomer), 2.05 (dd, J = 2 Hz, J = 13 Hz, 1 H, trans isomer), 1.81-0.90 (m, 16 H).

Step d: A solution of 193 (32 g, 73 mmol) in MeOH was treated with 8 g of 10% Pd/C and hydrogenated at 50 psi
25 overnight in a Parr apparatus. The mixture was filtered and the filtrate concentrated on a rotary evaporator to give 20 g (65 mmol) of the amine 194, which was used without further purification.

30 Step e: A solution of amine 194 (10 g, 32.8 mmol) in THF is treated with 3-acetylyphenyl isocyanate (5.3 g, 32.8 mmol) and the mixture is stirred for 30 min. The solvent is removed on a rotary evaporator and the residue is chromatographed on silica gel (0.5:4.5:95 NH₄OH/MeOH/CH₂Cl₂)
35 to give 11 g of urea 195 (Example 415) as a solid. Also obtained 2 g of cis isomer (Example 416a). The urea Example 415 was further purified by a second chromatography on silica gel (40:60:1 EtAc/Hex/TEA) and final

recrystallization from ether to give crystalline solid. mp
 115-117 °C, $[\alpha]_D^{25} = +16.8^\circ$ (CH₃OH, c = 0.23 g/dL). ¹H NMR
 (300 MHz, CDCl₃) δ 7.86 (m, 1 H), 7.78 (bs, 1 H), 7.68-7.64
 (m, 1 H), 7.62-7.59 (m, 1 H), 7.38 (t, J = 8 Hz, 1 H), 6.95-
 5 6.90 (m, 2 H), 6.79-6.72 (m, 2 H), 6.25 (s, 1 H), 3.21 (dt,
 J = 3 Hz, 11 Hz, 1 H), 3.00-2.97 (m, 1 H), 2.66-2.56 (m, 1
 H), 2.61 (s, 3 H), 2.44-2.32 (m, 4 H), 2.06 (dd, J = 2 Hz,
 J = 13 Hz, 1 H), 1.80-0.86 (m, 15 H). MS esi: (M+H)⁺ = 466.3
 (100%). Anal. Calcd for C₂₈H₃₆N₃O₂F: C, 72.23; H 7.70; N,
 10 9.02. Found: C, 72.33; H, 7.91; N, 9.00.

EXAMPLE 415a

N-(3-acetylphenyl)-N'-[(1R,2S)-2-[[[(3S)-3-(4-
fluorophenyl)methyl]piperidinyl]methyl]cyclohexyl]urea
Hydrochloride.

15 A solution of example 415 (15 g, 32 mmol) in 300 ml of THF
 was cooled in an ice bath and treated drop-wise with 36 ml
 20 of a 1 M HCl/ether solution. The resulting solution was
 stirred for 30 min and concentrated in vacuo. The resulting
 solid was titrated with ether and the resulting white
 solid dried under high vacuum overnight to give 16 g of the
 hydrochloride salt. mp 58-60 °C. $[\alpha]_D^{25} = +20.0^\circ$ (CH₃OH, c =
 25 0.23 g/dL). ¹H NMR (400 MHz, DMSO-D₆) δ 9.61 (s, 1 H), 9.15
 (s, 1 H), 8.00 (m, 1 H), 7.63-7.61 (m, 1 H), 7.51-7.49 (m, 1
 H), 7.39-7.34 (m, 1 H), 7.22-7.17 (m, 2 H), 7.09-7.04 (m, 2
 H), 6.86 (d, J = 8 Hz, 1 H), 3.47-3.31 (m, 4 H), 3.11 (m, 1
 H), 2.98-2.82 (m, 2 H), 2.67-2.62 (dd, J = 5 Hz, J = 13 Hz,
 30 1 H), 2.58-2.50 (m, 2 H), 2.52 (s, 3 H), 2.39 (dd, J = 8
 Hz, J = 13 Hz, 1 H), 2.16-2.06 (m, 2 H), 1.84-1.556 (m, 7
 H), 1.30-1.00 (m, 4 H). Anal. Calcd for
 C₂₈H₃₇N₃O₂FCl • H₂O • THF_{0.25}: C, 64.73; H 7.68; N, 7.81. Found: C,
 64.89; H, 7.41; N, 7.81.

35

EXAMPLE 415b

N-(3-acetylphenyl)-N'-[(1R,2S)-2-[[[(3S)-3-(4-fluorophenyl)methyl]piperidinyl]methyl]cyclohexyl]urea Benzenesulfonate.

5

Benzenesulfonic acid monohydrate (1.06 g, 6 mmol) was dried by azeotroping off the water of a benzene solution (twice) and adding the dried acid solution to a solution of example 415 (2.81 g, 6 mmol) in toluene (40 ml). The solvents were removed in vacuo (twice) and the resulting residue recrystallized twice from toluene and dried under high vacuum overnight give 2.77 g of benzenesulfonic acid salt as a white solid. mp 157-159 °C. $[\alpha]_D^{25} = +16.9^\circ$ (CH₃OH, c = 0.23 g/dL). Anal. Calcd for C₁₄H₂₂N₃O₃FS: C, 65.47; H 6.80; N, 6.75; S, 5.14. Found: C, 65.48; H, 6.80; N, 6.70; S, 5.35.



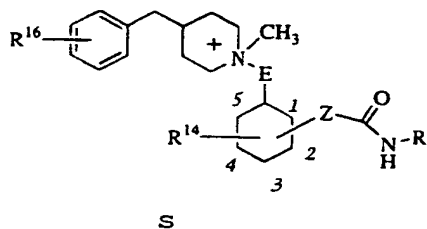
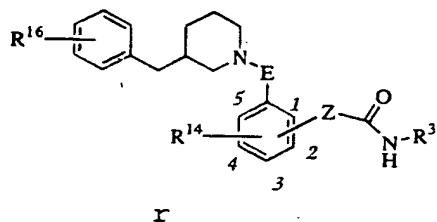
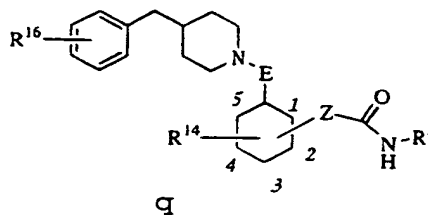
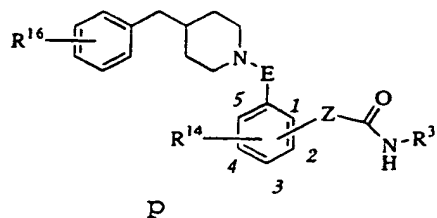

20 The compounds of Table 3a and Table 3.1 were prepared by procedures described in Schemes 26-31A, other examples and methods taught herein, and procedures familiar to one skilled in the art.

TABLE 3a



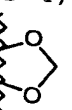
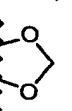
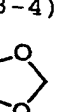

Ex #	Core	R ¹⁶	E	Z	R ¹⁴	R ³	MS M+H ⁺
218	p	H	CH ₂	(1) NH	H	1- (phenylmethyl) -4- piperidinyl]	497
219	p	H	CH ₂	(1) NH	H	2,5- difluorophenyl	436
220	p	H	CH ₂	(2) CH ₂ NH	H	2,5- difluorophenyl	450
221	p	H		(1) NH	H	2,5- difluorophenyl	464
222	p	H		(1) NH	H	2,5- difluorophenyl	466
223	p	H	C=NH	(2) NH	H	phenyl	413
224	p	H	CH ₂	(2) NH	H	1- (phenylmethyl) -4- piperidinyl]	497
225	p	H	CH ₂	(1) NH	H	2-(4- fluorophenyl)- ethyl	446

226	p	H	CH ₂	(1) NH	H	3- hydroxypropyl	382
227	p	H	CH ₂	(1) NH	H	2-(1- piperidinyl)- ethyl	435
228	p	H	CH ₂	(1) NH	H	2- (dimethylamino)ethyl	395
229	p	H	CH ₂	(1) NH	H	4- (phenylmethyl) -1-piperazine	483
230	p	H	CH ₂	(1) NH	H	4- (phenylmethyl) -1-piperidine	482
231	p	H	CH ₂	(1) NH	H	(1,3- benzodioxol-5- ylmethyl)	458
232	p	H	CH ₂	(1) NH	H	2,2- (diphenyl)ethy l	504
233	p	H	CH ₂	(1) NH	H	4-(4- chlorophenyl)- 4-hydroxy-1- piperidine	518
234	p	H	CH ₂	(1) NH	H	4-phenyl-4- hydroxy-1- piperidine	484
235	p	H	CH ₂	(1) NH	H	4-phenyl-1- piperidine	468
236	p	H	CH ₂	(1) NH	H	(1H)-indazol- 5-yl	440
237	p	H	CH ₂	(1) NH	H	(1H)-indazol- 6-yl	440
238	p	H	CH ₂	(1) NH	H	phenylmethyl	414
239	p	H	CH ₂	(1) NH	H	1,3- benzodioxol-5- yl	444

240	p	H	CH ₂	(1) NH	(3-4) 	1-(phenylmethyl)-4-piperidinyl]	541
241	p	H	CH ₂	(1) NH	(3-4) 	2-(4-fluorophenyl)-ethyl	490
242	p	H	CH ₂	(1) NH	(3-4) 	4-((2-phenyl)ethyl)-1-piperazine	541
243	p	H	CH ₂	(1) NH	(3-4) 	(1H)-indazol-5-yl	484
244	p	H	CH ₂	(1) NH	(3-4) 	(1H)-indazol-6-yl	484
245	p	H	CH ₂	(1) NH	(3-4) 	benzothiazol-6-yl	501
246	p	H	CH ₂	(1) NH	(4) OH	[2-(4-fluorophenyl)-ethyl	462
247	p	H	CH ₂	(1) NH	(4) OH	1-(phenylmethyl)-4-piperidinyl]	513
248	p	H	CH ₂	(1) NH	(3-4) 	3-phenylpropyl	486
249	p	H	CH ₂	(2) NH	H	(1H)-indazol-5-yl	440
250	p	H	CH ₂	(2) NH	H	[2-(4-fluorophenyl)-ethyl	446

251	p	H	bond	(1) NH	H	2,5- difluorophenyl	422
252	p	H	CH ₂	(1) NH	H	Phenyl	400
253	p	H	CH ₂	(1) NH	H	4- methoxyphenyl	430
254	p	H	CH ₂	(1) NH	H	3- methoxyphenyl	430
255	q	4-F	CH ₂	(2) NH	H	3- methoxyphenyl	454
256	q	4-F	CH ₂	(2) NH	H	3-acetylphenyl	466
257	r	H	CH ₂	(1) NH	H	3- methoxyphenyl	430
258	p	H	CH ₂	(2) NH	H	3-cyanophenyl	425
259	p	H	CH ₂	(3) NH	H	3-cyanophenyl	425
260	p	H	CH ₂	(3) NH	H	4- methoxyphenyl	430
261	p	H	CH ₂	(3) NH	H	2-phenylethyl	428
262	p	H	CH ₂	(1) NH	H	3-carboethoxy- phenyl	472
263	p	H	CH ₂	(1) NH	H	3-cyanophenyl	425
264	p	4-F	CH ₂	(1) NH	H	phenyl	418
265	p	H	CH ₂	(1) N- Benzyl	H	phenyl	490
266	p	H	CH ₂	(1) N- Benzyl	H	3-cyanophenyl	515

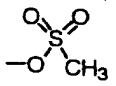
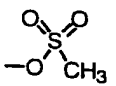

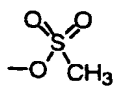
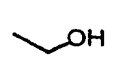
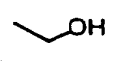

267	p	H	CH ₂	(1) NH	H	2-phenylethyl	428
268	p	H	CH ₂	(1) NH	(3-4) 	3-cyanophenyl	469
269	p	H	CH ₂	(1) NH	(3-4) 	3-carboethoxy-phenyl	516
270	p	H	CH ₂	(1) NH	(3-4) 	4-carboethoxy-phenyl	516
271	p	H	CH ₂	(1) NH	(4) OH	phenyl	416
272	p	H	CH ₂	(1) NH	(4) OH	3-cyanophenyl	441
273	p	H	CH ₂	(1) NH	(4) 	3-methoxyphenyl	524
274	p	H	CH ₂	(1) NH	(4) 	Trans-2-phenyl-cyclopropyl	534
275	p	H	CH ₂	(1) NH	(3) CO ₂ Me	3-cyanophenyl	483
276	p	H	CH ₂	(1) NH	(3) CO ₂ Me	3-methoxyphenyl	488

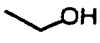
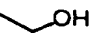
277	p	H	CH ₂	(1) NH	(4) 	3-cyanophenyl	519
278	p	H	CH ₂	(1) NH	(3) 	3-methoxyphenyl	460
279	p	H	CH ₂	(1) NH	(3) 	3-cyanophenyl	455
280	p	4-F	CH ₂	(1) NH	(4) CO ₂ Me	3-cyanophenyl	501
280a	p	4-F	CH ₂	(1) NH	(5) CO ₂ Me	3-cyanophenyl	501
280b	p	4-F	CH ₂	(1) NH	(5) CONMe	3-cyanophenyl	500
280c	p	4-F	CH ₂	(1) NH	(5) CONH ₂	3-cyanophenyl	486
280d	P	4-F	CH ₂	(1) NH	(5) CO ₂ Me	3-(1-hydroxyethyl)-phenyl	520
280e	r	H	CH ₂	(1) NH	(5) CO ₂ Me	phenyl	458
280f	P	4-F	CH ₂	(1) NH	(5) CO ₂ H	phenyl	462
280g	r	H	CH ₂	(1) NH	(5) CO ₂ Me	3-cyanophenyl	483
280h	r	H	CH ₂	(1) NH	(5) CO ₂ Me	3-methoxyphenyl	488

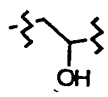
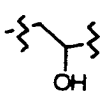
280i	r	H	CH ₂	(1) NH	(5) CO ₂ Me	3-acetylphenyl	500
280j	p	4-F	CH ₂ HCl (salt)	(1) NH	(5) CO ₂ Me	3-acetylphenyl	518
280k	p	4-F	CH ₂ HCl (salt)	(1) NH	(5) CO ₂ Me	3-cyanophenyl	501
281	p	4-F	CH ₂	(1) NH	(4) CO ₂ Me	phenyl	476
281a	p	4-F	CH ₂	(1) NH	(5) CO ₂ Me	phenyl	476
281b	p	4-F	CH ₂	(1) NH	(5) CONMe	phenyl	475
281c	p	4-F	CH ₂	(1) NH	(5) CONH ₂	phenyl	461
282	p	4-F	CH ₂	(1) NH	(4) CO ₂ Me	3-methoxyphenyl	506
282a	p	4-F	CH ₂	(1) NH	(5) CO ₂ Me	3-methoxyphenyl	506
282b	p	4-F	CH ₂	(1) NH	(5) CONMe	3-methoxyphenyl	505
282c	p	4-F	CH ₂	(1) NH	(5) CO ₂ Me	3-acetylphenyl	518
282d	p	4-F	CH ₂	(1) NH	(5) CONMe	3-acetylphenyl	517
282e	p	4-F	CH ₂	(1) NH	(5) CONH ₂	3-acetylphenyl	503

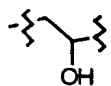
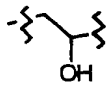
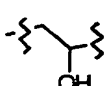
283	p	4-F	CH ₂	(1) NH	(4) 	3-cyanophenyl	473
284	p	4-F	CH ₂	(1) NH	(3-4) fused Phenyl	3-cyanophenyl	493
285	p	4-F	CH ₂	(1) NH	(3-4) fused Phenyl	3- methoxyphenyl	498
286	p	4-F	CH ₂	(1) NH	(4) -CONPh	3-cyanophenyl	562
286a	p	4-F	CH ₂	(1) NH	(5) -CONPh	3-cyanophenyl	562
286b	p	4-F	CH ₂	(1) NH	(5) -CONPh	3-acetylphenyl	579
287	p	4-F	CH ₂	(1) NH	(4) 	3- methoxyphenyl	478
288	p	4-F	CH ₂	(1) NH	(4) CONMe	3-cyanophenyl	500
288a	p	4-F	CH ₂ HCl (sa lt)	(1) NH	(4) CONMe	3-cyanophenyl	500
288b	p	4-F	CH ₂ HCl (sa lt)	(1) NH	(5) CONMe	3-acetylphenyl	517
288c	p	4-F	CH ₂	(1) NH	(5) CON (CH ₂) ₂ NMe ₂	3-acetylphenyl	574
288d	p	4-F	CH ₂	(1) NH	(5) CON (CH ₂) ₂ NMe ₂	3-acetylphenyl	557

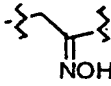
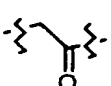
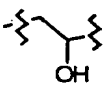
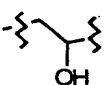
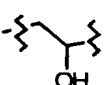
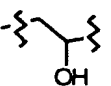
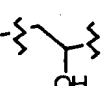
288e	p	4-F	CH ₂	(1) NH	(5) CON C ₃ H ₅	3-acetylphenyl	453
288f	p	4-F	CH ₂	(1) NH	(5) CON C ₃ H ₅	3-acetylphenyl	531
288g	p	4-F	CH ₂	(1) NH	(5) CONMe ₂	3- methoxyphenyl	519
288h	p	4-F	CH ₂	(1) NH	(5) CONMe ₂	3-acetylphenyl	531
288i	p	4-F	CH ₂	(1) NH	(5) CON(2- pyridi nyl)	3-acetylphenyl	580
288j	p	4-F	CH ₂	(1) NH	(5) CONMe ₂	3- methoxyphenyl	568
289	p	H	CH ₂	(1) CH ₂ NH	H	2,5- difluorophenyl	450
290	p	H	CH ₂	(1) CH ₂ NH	H	3-cyanophenyl	439
291	p	H	CH ₂	(1) CH ₂ NH	H	3-carboethoxy- phenyl	486
292	p	H	CH ₂	(1) CH ₂ NH	H	3- methoxyphenyl	444
293	p	H	CH ₂	(1) CH ₂ NH	H	4- methoxyphenyl	444
294	p	H		(1) NH	H	3- methoxyphenyl	460
295	r	H		(1) NH	H	3- methoxyphenyl	460

296	p	H		(1) NH	H	3-cyanophenyl	455
297	p	H		(1) NH	H	3-carboethoxy-phenyl	502
298	p	H		(1) NH	H	phenyl	430
299	p	4-F	CH ₂	(1) NH	(5) 	phenyl	448
300	p	H		(1) NH	H	phenyl	443
301	p	H		(2) NH	H	phenyl	428
302	p	H		(2) NH	H	phenyl	430
303	p	4-F		(1) NH	H	phenyl	448
304	p	4-F		(1) NH	H	3-methoxyphenyl	478
305	p	4-F		(1) NH	H	3-cyanophenyl	473
306	p	H		(1) NH	(3-4) 	3-cyanophenyl	499

307	p	H	CH ₂ - CH ₂	(1) NH	H	3-cyanophenyl	439
308	p	4-F	CH ₂ - CH ₂	(1) NH	H	3-cyanophenyl	457
309	p	H	CH ₂ - CH ₂	(1) NH	H	3- methoxyphenyl	444
310	p	4-F	CH ₂ CH ₂	(1) NH	H	3- methoxyphenyl	462
311	r	H	CH ₂ - CH ₂	(1) NH	H	3- methoxyphenyl	444
312	p	4-F	CH ₂ - CH ₂	(1) NH	H	3-acetylphenyl	474
313	p	4-F	CH ₂ - CH ₂	(1) NH	H	4-fluorophenyl	450
314	p	4-F	CH ₂ - CH ₂	(1) NH	H	1-adamantyl	490
315	s	H	CH ₂	(1) NH	(3-4) 	3-cyanophenyl	483 (M+)
316	s	H	CH ₂	(1) NH	(4) OH	3-cyanophenyl	455 (M+)
317	s	H	CH ₂	(1) NH	(4) O- (2-THP)	3-cyanophenyl	539 (M+)

TABLE 3.1



a

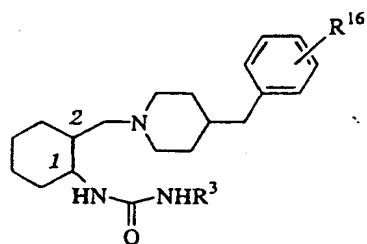
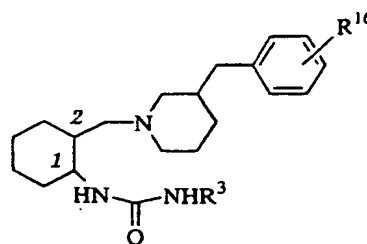

b

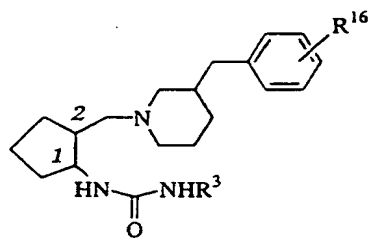

c

Ex #	Core	R ¹⁶	Stereo-chemistry	Salt Form	R ³	MS M+H ⁺
400	a	H	1,2 trans racemic	-	3-methoxyphenyl	436
401	a	4-F	1,2 trans racemic	-	3-methoxyphenyl	454
402	a	H	1,2 cis racemic	-	3-methoxyphenyl	436
403	a	4-F	1,2 trans racemic	-	3-cyanophenyl	449
403a	a	4-F	1,2 trans racemic	-	3-acetylphenyl	466
403b	a	4-F	1,2 trans racemic	-	3-nitrophenyl	469
403c	a	4-F	1,2 trans racemic	-	4-nitrophenyl	469
403d	a	4-F	1,2 trans racemic	-	4-pyridinyl	425
403e	a	4-F	1,2 trans racemic	HCl	3-acetylphenyl	466
403f	a	4-F	1,2 trans racemic	-	(1H)-indazol-5-yl	464
404	a	4-F	1S,2R	-	3-acetylphenyl	466
405	a	4-F	1S,2R	-	3-cyanophenyl	449
406	a	4-F	1S,2R	-	3-methoxyphenyl	454

407	a	4-F	1S, 2R	-	phenyl	424
408	a	4-F	1R, 2S	-	3-acetylphenyl	466
409	a	4-F	1R, 2S	-	3-cyanophenyl	449
410	a	4-F	1R, 2S	-	3-methoxyphenyl	454
411	a	4-F	1R, 2S	-	phenyl	424
412	a	4-F	1R, 2S	-	phenylmethyl	438
413	a	4-F	1R, 2S	-	(1H)-indazol-5-yl	464
414	a	4-F	1R, 2S	-	(1H)-indol-5-yl	463
414a	b	H	1,2 trans (3RS) racemic	-	3-methoxyphenyl	464
414b	b	H	1,2 trans (3RS) racemic	-	3-cyanophenyl	431
414c	b	H	1,2 trans (3RS) racemic	-	3-acetylphenyl	448
414d	b	4-F	1,2 trans (3RS) racemic	-	3-acetylphenyl	466
414e	b	4-F	1,2 trans (3RS) racemic	-	3-cyanophenyl	449
414f	b	4-F	1,2 trans (3RS) racemic	-	3-methoxyphenyl	454
414g	b	4-F	1,2 trans (3RS) racemic	-	3-nitrophenyl	469
415	b	4-F	1R, 2S, 3S	-	3-acetylphenyl	466
415a	b	4-F	1R, 2S, 3S	HCl	3-acetylphenyl	466
415b	b	4-F	1R, 2S, 3S	Besyl	3-acetylphenyl	466
416	b	4-F	1R, 2S, 3R	-	3-acetylphenyl	466
416a	b	4-F	1R, 2R, 3S	-	3-acetylphenyl	466
416b	b	4-F	1R, 2S, 3R	HCl	3-acetylphenyl	466
417	b	4-F	1R, 2S, 3S	-	3-cyanophenyl	449
418	b	4-F	1R, 2S, 3R	-	3-cyanophenyl	449

419	b	4-F	1R, 2S, 3S	-	3-methoxyphenyl	454
420	b	4-F	1R, 2S, 3R	-	3-methoxyphenyl	454
421	b	4-F	1R, 2S, 3S	-	4-fluorophenyl	442
422	b	4-F	1R, 2S, 3R	-	4-fluorophenyl	442
423	b	4-F	1R, 2S, 3S	-	phenyl	424
424	b	4-F	1R, 2S, 3S	-	(1H)-indazol-5-yl	464
425	b	4-F	1R, 2S, 3S	-	(1H)-indazol-6-yl	464
426	b	4-F	1R, 2S, 3S	-	benzthiazol-6-yl	481
427	b	4-F	1R, 2S, 3S	-	(1H)-indol-5-yl	463
428	b	4-F	1R, 2S, 3S	-	(1H)-indol-6-yl	463
429	b	4-F	1R, 2S, 3S	-	(1H)-2,3-dimethylindol-5-yl	491
430	b	4-F	1R, 2S, 3S	-	benzimidazol-5-yl	464
431	b	4-F	1R, 2S, 3S	-	indolin-5-yl	465
432	b	4-F	1R, 2S, 3S	-	3-cyano-4-fluorophenyl	467
433	b	4-F	1R, 2S, 3S	-	3-acetyl-4-fluorophenyl	484
434	b	4-F	1R, 2S, 3S	-	3,5-diacetylphenyl	508
435	b	4-F	1R, 2S, 3S	-	3-(1-hydroxyethyl)-phenyl	468
436	b	4-F	1R, 2S, 3S	-	4-methyl-thiazol-2-yl	445
437	b	4-F	1R, 2S, 3S	-	4-methyl-5-acetyl-thiazol-2-yl	487
438	b	4-F	1R, 2S, 3S	-	1,3,4-thiadiazol-2-yl	432
439	b	4-F	1R, 2S, 3S	-	4-chlorobenzthiazol-2-yl	515
440	b	4-F	1R, 2S, 3S	-	thiazol-2-yl	431
441	b	4-F	1R, 2S, 3S	-	5-methyl-isoxazol-3-yl	429
442	b	4-F	1R, 2S, 3S	-	1-methyl-pyrazol-3-yl	428
443	b	4-F	1R, 2S, 3S	-	4-(1,2,4-triazol-1-yl)phenyl	491
443a	b	4-F	1R, 2R, 3S	-	4-(1,2,4-triazol-1-yl)phenyl	491
444	b	4-F	1R, 2S, 3S	-	(1H)-3-chloroindazol-5-yl	499

445	b	4-F	1R, 2S, 3S	-	4-fluorophenyl	492
446	b	4-F	1R, 2S, 3S	-	4-chlorophenyl	458
447	b	4-F	1R, 2S, 3S	-	4-bromophenyl	502
448	b	4-F	1R, 2S, 3S	-	3-bromophenyl	502
449	b	4-F	1R, 2S, 3S	-	3-fluorophenyl	442
450	b	4-F	1R, 2S, 3S	-	3,4-difluorophenyl	460
451	b	4-F	1R, 2S, 3S	-	3-chloro-4-fluorophenyl	476
452	b	4-F	1R, 2S, 3S	-	3,5-dichlorophenyl	492
453	c	4-F	1R, 2S, 3S	-	3-acetylphenyl	452
454	c	4-F	1R, 2S, 3R	-	3-acetylphenyl	452
455	c	4-F	1R, 2R, 3S	-	3-acetylphenyl	452
456	c	4-F	1R, 2S, 3S	-	3-cyanophenyl	435
457	c	4-F	1R, 2S, 3R	-	3-cyanophenyl	435
458	c	4-F	1R, 2R, 3S	-	3-cyanophenyl	435
458a	c	4-F	1R, 2R, 3R	-	3-cyanophenyl	435
459	c	4-F	1R, 2S, 3S	-	phenyl	410
460	c	4-F	1R, 2S, 3R	-	phenyl	410
461	c	4-F	1R, 2R, 3S	-	phenyl	410
462	b	4-F	1R, 2S, 3S	-	(1H)-5-amino-indazol-1-yl	464
463	b	4-F	1R, 2S, 3S	-	3-chlorophenyl	458
464	b	4-F	1R, 2S, 3S	-	3-fluoro-4-methylphenyl	456
465	b	4-F	1R, 2S, 3S	-	3-cyano-4-(1-pyrazolyl)phenyl	515
466	b	4-F	1R, 2S, 3S	-	2-methylphenyl	454
467	b	4-F	1R, 2S, 3S	-	2-methylphenyl	438
468	b	4-F	1R, 2S, 3S	-	2,4-dimethylphenyl	452
469	b	4-F	1R, 2S, 3S	-	2,4-dimethoxyphenyl	484
470	b	4-F	1R, 2S, 3S	-	2,5-dimethoxyphenyl	484

471	b	4-F	1R, 2S, 3S	-	2-methoxy-5-methylphenyl	468
472	b	4-F	1R, 2S, 3S	-	2-methyl-5-fluorophenyl	456
473	b	4-F	1R, 2S, 3S	-	3,5-bis((1H)-1-methyltetrazol-5-yl)phenyl	588
474	b	4-F	1R, 2S, 3S	-	(3-((1H)-1-methyltetrazol-5-yl)phenyl	506
475	b	4-F	1R, 2S, 3S	-	(4-(carboethoxymethyl)thiazol-2-yl	517
476	b	4-F	1R, 2S, 3S	-	5-bromothiazol-2-yl	509
477	b	4-F	1R, 2S, 3S	-	4,5-di(4-fluorophenyl)thiazol-2-yl	619
478	b	4-F	1R, 2S, 3S	-	2-fluorophenyl	442
479	b	4-F	1R, 2S, 3S	-	2-chlorophenyl	458
480	b	4-F	1R, 2S, 3S	CF, CO ₂ H	indanon-6-yl	478
481	b	4-F	1R, 2S, 3S	CF, CO ₂ H	indanon-4-yl	478
482	b	4-F	1R, 2S, 3S	CF, CO ₂ H	4-(isopropyl)phenyl	466
483	b	4-F	1R, 2S, 3S	CF, CO ₂ H	3-nitro-4-methylphenyl	483
484	b	4-F	1R, 2S, 3S	CF, CO ₂ H	trans-2-phenylcycloprop-1-yl	464
485	b	4-F	1R, 2S, 3S	CF, CO ₂ H	2,4-difluorophenyl	460
486	b	4-F	1R, 2S, 3S	CF, CO ₂ H	2,5-difluorophenyl	460
487	b	4-F	1R, 2S, 3S	CF, CO ₂ H	2,4-dichlorophenyl	492
488	b	4-F	1R, 2S, 3S	CF, CO ₂ H	2,5-dichlorophenyl	492
489	b	4-F	1R, 2S, 3S	CF, CO ₂ H	2-methoxyphenyl	454
490	b	4-F	1R, 2S, 3S	CF, CO ₂ H	2,4-dimethoxyphenyl	484
491	b	4-F	1R, 2S, 3S	CF, CO ₂ H	2,5-dimethoxyphenyl	484
492	b	4-F	1R, 2S, 3S	CF, CO ₂ H	2-trifluoromethylphenyl	492
493	b	4-F	1R, 2S, 3S	CF, CO ₂ H	2-methylphenyl	438
494	b	4-F	1R, 2S, 3S	CF, CO ₂ H	3-trifluoromethylphenyl	492

495	b	4-F	1R, 2S, 3S	CF ₃ CO ₂ H	3-methylphenyl	438
496	b	4-F	1R, 2S, 3S	CF ₃ CO ₂ H	4-methoxyphenyl	454
497	b	4-F	1R, 2S, 3S	CF ₃ CO ₂ H	4-carboethoxy-phenyl	496
498	b	4-F	1R, 2S, 3S	CF ₃ CO ₂ H	4-trifluoromethyl-phenyl	492
499	b	4-F	1R, 2S, 3S	CF ₃ CO ₂ H	4-methylphenyl	438
500	b	4-F	1R, 2S, 3S	CF ₃ CO ₂ H	2-fluorophenyl	442
501	b	4-F	1R, 2S, 3S	CF ₃ CO ₂ H	2-chlorophenyl	458
502	b	4-F	1R, 2S, 3S	CF ₃ CO ₂ H	2-nitrophenyl	469
503	b	4-F	1R, 2S, 3S	CF ₃ CO ₂ H	2,4-dichlorophenyl	563
504	b	4-F	1R, 2S, 3S	CF ₃ CO ₂ H	3-nitrophenyl	469
505	b	4-F	1R, 2S, 3S	CF ₃ CO ₂ H	3,5-di(trifluoromethyl)-phenyl	560
506	b	4-F	1R, 2S, 3S	CF ₃ CO ₂ H	2,4-dimethylphenyl	452
507	b	4-F	1R, 2S, 3S	CF ₃ CO ₂ H	2,4-dimethoxy-5-chlorophenyl	518
508	b	4-F	1R, 2S, 3S	CF ₃ CO ₂ H	3,4,5-trimethoxyphenyl	514
509	b	4-F	1R, 2S, 3S	CF ₃ CO ₂ H	3,5-dimethylphenyl	452
510	b	4-F	1R, 2S, 3S	CF ₃ CO ₂ H	3-trifluoromethyl-4-chlorophenyl	526
511	b	4-F	1R, 2S, 3S	CF ₃ CO ₂ H	4-phenoxyphenyl	516
512	b	4-F	1R, 2S, 3S	CF ₃ CO ₂ H	4-ethoxyphenyl	468
513	b	4-F	1R, 2S, 3S	CF ₃ CO ₂ H	4-thiomethylphenyl	470
514	b	4-F	1R, 2S, 3S	CF ₃ CO ₂ H	2-naphthyl	474
515	b	4-F	1R, 2S, 3S	CF ₃ CO ₂ H	4-acetylphenyl	466
516	b	4-F	1R, 2S, 3S	CF ₃ CO ₂ H	2,6-dichloro-pyridin-4-yl	493
517	b	4-F	1R, 2S, 3S	CF ₃ CO ₂ H	5-indan-4-yl	464
518	b	4-F	1R, 2S, 3S	CF ₃ CO ₂ H	4-chloronaphth-1-yl	508
519	b	4-F	1R, 2S, 3S	CF ₃ CO ₂ H	3-fluoro-4-methoxyphenyl	472
520	b	4-F	1R, 2S, 3S	CF ₃ CO ₂ H	4-(methylsulfonyl)-phenyl	502

521	b	4-F	1R, 2S, 3S	CF, CO ₂ H	3-(methylsulfonyl)-phenyl	502
522	b	4-F	1R, 2S, 3S	CF, CO ₂ H	2-((1H)-pyrrol-1-yl)phenyl	489
523	b	4-F	1R, 2S, 3S	CF, CO ₂ H	1,3-benzodioxol-5-yl	468
524	b	4-F	1R, 2S, 3S	CF, CO ₂ H	1-acetyllindolin-6-yl	507
525	b	4-F	1R, 2S, 3S	CF, CO ₂ H	4-(6-methylbenzothiazol-2-yl)phenyl	571
526	b	4-F	1R, 2S, 3S	CF, CO ₂ H	4-((2,2-dimethylpropanoyl)amino)phenyl	523
527	b	4-F	1R, 2S, 3S	CF, CO ₂ H	4-(1-methyltetrazol-5-yl)phenyl	506
528	b	4-F	1R, 2S, 3S	CF, CO ₂ H	4-(1-morpholino)phenyl	509
529	b	4-F	1R, 2S, 3S	CF, CO ₂ H	quinolin-8-yl	475
530	b	4-F	1R, 2S, 3S	CF, CO ₂ H	3-hydroxyphenyl	440
531	b	4-F	1R, 2S, 3S	CF, CO ₂ H	4-(acetylamino)-phenyl	481
532	b	4-F	1R, 2S, 3S	CF, CO ₂ H	4-hydroxyphenyl	440
533	b	4-F	1R, 2S, 3S	CF, CO ₂ H	3-hydroxy-4-methoxyphenyl	470
534	b	4-F	1R, 2S, 3S	CF, CO ₂ H	3-(acetylamino)-phenyl	481
535	b	4-F	1R, 2S, 3S	CF, CO ₂ H	4-fluoro-3-methylphenyl	456
536	b	4-F	1R, 2S, 3S	CF, CO ₂ H	3-methoxy-4-methylphenyl	468
537	b	4-F	1R, 2S, 3S	CF, CO ₂ H	4-chloro-3-methylphenyl	472
538	b	4-F	1R, 2S, 3S	CF, CO ₂ H	4-(N-methylcarboxamide)phenyl	481
539	b	4-F	1R, 2S, 3S	CF, CO ₂ H	1-adamantyl	482
540	b	4-F	1R, 2S, 3S	CF, CO ₂ H	quinolin-5-yl	475
541	b	4-F	1R, 2S, 3S	CF, CO ₂ H	quinolin-6-yl	475
542	b	4-F	1R, 2S, 3S	CF, CO ₂ H	1,4-benzodioxan-6-yl	482
543	b	4-F	1R, 2S, 3S	CF, CO ₂ H	isoquinolin-5-yl	475
544	b	4-F	1R, 2S, 3S	CF, CO ₂ H	4-(sulfonamide)-phenyl	503
545	b	4-F	1R, 2S, 3S	CF, CO ₂ H	benzotriazol-5-yl	465

546	b	4-F	1R, 2S, 3S	CF ₃ CO ₂ H	2-hydroxy-4-methylphenyl	454
547	b	4-F	1R, 2S, 3S	CF ₃ CO ₂ H	3-hydroxy-4-methylphenyl	454
548	b	4-F	1R, 2S, 3S	CF ₃ CO ₂ H	2-methyl-benzothiazol-5-yl	495
549	b	4-F	1R, 2S, 3S	CF ₃ CO ₂ H	(4-methoxyphenyl)-methyl	468
550	b	4-F	1R, 2S, 3S	CF ₃ CO ₂ H	(4-fluorophenyl)-methyl	456
551	b	4-F	1R, 2S, 3S	CF ₃ CO ₂ H	(4-methylphenyl)-methyl	452
552	b	4-F	1R, 2S, 3S	CF ₃ CO ₂ H	(1R)-1-(phenyl)ethyl	452
553	b	4-F	1R, 2S, 3S	CF ₃ CO ₂ H	1-acetyllindolin-5-yl	507
554	b	4-F	1R, 2S, 3S	CF ₃ CO ₂ H	5,6,7,8-tetrahydronaphth-1-yl	478
555	b	4-F	1R, 2S, 3S	CF ₃ CO ₂ H	3-acetyl-4-hydroxyphenyl	482
556	b	4-F	1R, 2S, 3S	CF ₃ CO ₂ H	4-(piperidin-1-yl)phenyl	507
557	b	4-F	1R, 2S, 3S	CF ₃ CO ₂ H	cyclohexyl	430
558	b	4-F	1R, 2S, 3S	CF ₃ CO ₂ H	2-methoxyphenyl	468
559	b	4-F	1R, 2S, 3S	CF ₃ CO ₂ H	2,6-dimethylphenyl	452
560	b	4-F	1R, 2S, 3S	CF ₃ CO ₂ H	2-ethylphenyl	452
561	b	4-F	1R, 2S, 3S	CF ₃ CO ₂ H	2,4,6-trimethylphenyl	466
562	b	4-F	1R, 2S, 3S	CF ₃ CO ₂ H	2,5-dimethoxyphenyl	484
563	b	4-F	1R, 2S, 3S	CF ₃ CO ₂ H	t-butyl	404
564	b	4-F	1R, 2S, 3S	CF ₃ CO ₂ H	i-propyl	390
565	b	4-F	1R, 2S, 3S	CF ₃ CO ₂ H	Ethoxycarbonyl-methyl	434
566	b	4-F	1R, 2S, 3S	CF ₃ CO ₂ H	2-trifluoromethoxyphenyl	508
567	b	4-F	1R, 2S, 3S	CF ₃ CO ₂ H	(1R, S)-1--(methoxycarbonyl)-2-methyl-propyl	462
568	b	4-F	1R, 2S, 3S	CF ₃ CO ₂ H	[(1S)-1-(methoxycarbonyl)-2-phenylethyl	510
569	b	4-F	1R, 2S, 3S	CF ₃ CO ₂ H	2,4,4-trimethyl-2-pentyl	460
570	b	4-F	1R, 2S, 3S	CF ₃ CO ₂ H	2-phenylethyl	452

571	b	4-F	1R, 2S, 3S	CF ₃ CO ₂ H	3-acetylphenyl	466
572	b	4-F	1R, 2S, 3S	CF ₃ CO ₂ H	2-carbomethoxy-phenyl	482
573	b	4-F	1R, 2S, 3S	CF ₃ CO ₂ H	(1S)-1-(phenyl) ethyl	452
574	b	4-F	1R, 2S, 3S	CF ₃ CO ₂ H	4-(phenyl)phenyl	500
575	b	4-F	1R, 2S, 3S	CF ₃ CO ₂ H	1-naphthyl	474
576	b	4-F	1R, 2S, 3S	CF ₃ CO ₂ H	2-(phenyl)phenyl	500
577	b	4-F	1R, 2S, 3S	CF ₃ CO ₂ H	Phenylmethoxy	454
578	b	4-F	1R, 2S, 3S	CF ₃ CO ₂ H	3,4-dimethoxyphenyl	484
579	b	4-F	1R, 2S, 3S	CF ₃ CO ₂ H	(3H)-2-ethylquinazolin-4-on-3-yl	520
580	b	4-F	1R, 2S, 3S	CF ₃ CO ₂ H	3-pyridinyl	425
581	b	4-F	1R, 2S, 3S	CF ₃ CO ₂ H	6-methoxy-3-pyridinyl	455
582	b	4-F	1R, 2S, 3S	CF ₃ CO ₂ H	2-methylquinolin-8-yl	489
583	b	4-F	1R, 2S, 3S	CF ₃ CO ₂ H	2-methylnaphth-1-yl	488
584	b	4-F	1R, 2S, 3S	CF ₃ CO ₂ H	4-((1H)-1-propyl-tetrazol-5-yl)phenyl	534
585	b	4-F	1R, 2S, 3S	CF ₃ CO ₂ H	3-aminophenyl	439
586	b	4-F	1R, 2S, 3S	-	3-(acetylamino)-phenyl	481
587	b	4-F	1R, 2S, 3S	CF ₃ CO ₂ H	3-(N-methylcarbamoyl)-phenyl	481
588	b	4-F	1R, 2S, 3S	CF ₃ CO ₂ H	2-nitro-4-methoxyphenyl	499
589	b	4-F	1R, 2S, 3S	CF ₃ CO ₂ H	8-hydroxyquinolin-5-yl	491
590	b	4-F	1R, 2S, 3S	CF ₃ CO ₂ H	3-methylpyridin-2-yl	439
591	b	4-F	1R, 2S, 3S	CF ₃ CO ₂ H	isoquinolin-1-yl	475

Example 318

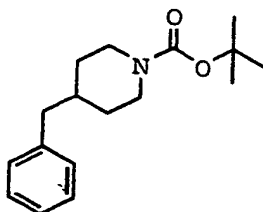

Part A: Preparation of 1-*t*-butyloxycarbonyl-4-benzylpiperidine

5

4-benzylpiperidine (10.0 g, 57.1 mmol, 1.0 eq.) was dissolved in 100 mL of THF under N₂ and subsequently cooled to 0 °C. Di-*tert*-butyl dicarbonate (11.21 g, 51.3 mmol, 0.9 eq.) dissolved in 50 mL of THF, was added dropwise. Gas evolution was observed. Once gas evolution ceased, the ice bath was removed. After 20 hours, the THF was removed *in vacuo* then the residue was dissolved in EtOAc and rinsed 3X with 1N citric acid, 1X with brine. The organic was dried over magnesium sulfate and stripped to yield 15.4 g of colorless oil as

10

15

product. Yield = 97.9%. NMR (300 MHz, CDCl₃) δ 7.35-7.17 (m, 3H); 7.14 (d, 2H, J = 7 Hz); 4.20-3.90 (m, 2H); 2.75-2.55 (m, 2H); 2.54 (d, 2H, J = 7 Hz); 1.70-1.50 (m, 3H); 1.46 (s, 9H); 1.20-1.00 (m, 2H).

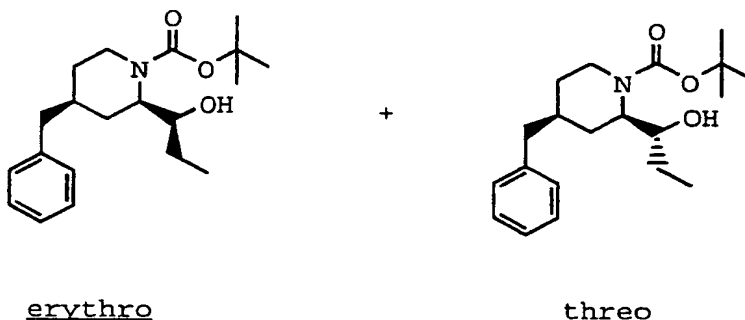

5

Part B: Preparation of erythro-and threo-cis-4-benzyl-1-t-butoxycarbonyl-2-ethylpiperidinemethanol

1-t-butoxycarbonyl-4-benzylpiperidine (5.0 g, 18.2 mmol, 1.0 eq.) was dissolved in Et₂O at 25 °C under N₂ and cooled to -78 °C. N,N,N',N'-Tetramethylethylenediamine (TMEDA) (3.29 mL, 21.8 mmol, 1.2 eq.) was added followed by the dropwise addition of sec-butyllithium (16.76 mL, 21.8 mmol, 1.2 eq.). The reaction was allowed to warm and stir at -30 °C for 30 minutes then again cooled to -78 °C. Once cool, propionaldehyde (1.31 mL, 20.0 mmol, 1.1 eq.) was added neat. The reaction was allowed warmed to warm to -30 °C then immediately quenched with 10 mL of water and the organic layer was separated. The aqueous layer was extracted 2X more with Et₂O. The organic layers were combined, dried over magnesium sulfate and the solvent removed *in vacuo* to yield a colorless oil which was purified by flash chromatography in 4 : 1 to 1 : 1 hexane/EtOAc. Obtained 0.68 g of a colorless oil as isomer A, yield = 11.2% and 0.91 g of a colorless oil as isomer B, yield = 15.0%.

Isomer A NMR (300 MHz, CDCl₃) δ 7.40-7.25 (m, 2H); 7.21 (d, 1H, J = 7 Hz); 7.16 (d, 2H, J = 7 Hz); 3.60-3.30 (m, 2H); 2.56 (d, 2H J = 7 Hz); 1.90-1.00 (m, 7H); 1.46 (s, 9H); 1.00-0.70 (m, 5H).

Isomer B NMR (300 MHz, CDCl₃) δ 7.30-7.23 (m, 2H); 7.20 (d, 1H, J = 7 Hz); 7.14 (d, 2H, J = 7 Hz.); 3.60-3.20 (m, 2H);

2.60-2.40 (m, 2H); 1.90-1.00 (m, 9H); 1.44 (s, 9H); 0.96 (t, 3H, J = 7 Hz).

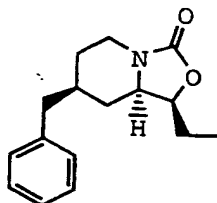

5

erythro

10 Part C: Structure determination of Isomer B via cyclization to 4 α ,6 α ,7 α -4-benzyl-7-ethyl-8-oxa-1-azabicyclo[4.3.0]nonane-9-one

15

Isomer B (60 mg, 0.18 mmol, 1 eq.) was dissolved in DMF at 25 °C under N₂, then NaH (7.9 mg, 0.198 mmol, 1 eq.) was added. After 20 hours, 2 mL of water was added followed by EtOAc. The layers were separated. The aqueous layer was

20

extracted 2X more with EtOAc. The organic layers were combined, dried over magnesium sulfate, and the solvent removed *in vacuo* to yield an oil which was purified over silica gel in 9:1 to 1:1 hexane/EtOAc. Obtained 30 mg. Yield = 64%. Product structure confirmed by N.O.E. NMR

25

(300 MHz, CDCl₃) δ 7.40-7.20 (m, 3H); 7.16 (d, 2H, J = 7 Hz); 4.45-4.25 (m, 1H); 4.00-3.80 (m, 1H); 3.65-3.45 (m, 1H); 2.95-2.70 (m, 1H); 2.65-2.45 (m, 2H); 1.85-1.40 (m, 4H); 1.40-1.00 (m, 6H).

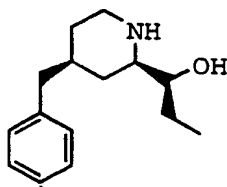

Part D: Preparation of erythro-cis-4-benzyl- α -
 5 ethylpiperidinemethanol

Erythro-cis-4-benzyl-1-t-butoxycarbonyl--
 ethylpiperidinemethanol(isomer B from part B) (815 mg, 2.44
 mmol, 1 eq.) was dissolved in 8 mL of ethanol at 25 °C under
 10 N₂. NaOH (391 mg, 9.78 mmol, 4 eq.) was added and the
 mixture refluxed for 4 hours. The solvent was removed *in*
vacuo to yield an oil. Water was added followed by EtOAc.
 The layers were separated. The aqueous layer was extracted
 2X more with EtOAc. The organic layers were combined dried
 15 over magnesium sulfate, and the solvent removed *in vacuo* to
 yield 390 mg of an oil. Yield = 68%. NMR (300 MHz, CDCl₃)
 • 7.35-7.20 (m, 2H); 7.23-7.00 (m, 3H); 3.75-3.65 (m, 1H);
 3.20-3.00 (m, 1H); 2.90-2.40 (m, 4H); 1.70-1.50 (m, 2H);
 20 1.50-1.30 (m, 1H); 1.20-0.80 (m, 5H).

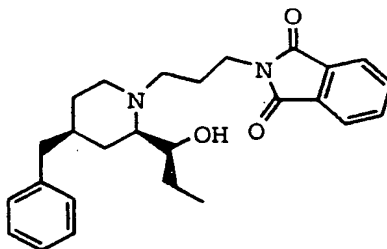

Part E: Preparation of erythro-cis-4-benzyl- α -ethyl-1-
 25 (3-N-phthalimido-n-prop-1-yl)piperidinemethanol

Erythro-cis-4-benzyl- α -ethylpiperidinemethanol

(195 mg, 0.84 mmol, 1 eq.), N-(3-bromopropyl)phthalimide (224 mg, 0.84 mmol, 1 eq.), potassium iodide (139 mg, 0.84 mmol, 1 eq.), and potassium carbonate (231 mg, 0.84 mmol, 1 eq.) were refluxed in 10 mL of 2-butanone for 3 hours. The
 5 reaction was worked up by filtering off the inorganic solids. The filtrate solvent was removed *in vacuo* to yield an oil. Purified by flash chromatography in 100% EtOAc then 4:1 chloroform/MeOH. Obtained 200 mg. Yield = 57%.

NMR (300 MHz, CDCl₃) δ 7.95-7.80 (m, 2H); 7.80-7.65 (m, 2H); 7.35-7.00 (m, 5H); 3.90-3.60 (m, 3H); 3.20-2.90 (m, 2H); 2.65-2.30 (m, 3H); 2.20-2.00 (m, 2H); 2.00-1.75 (m, 2H); 1.70-1.40 (m, 4H); 1.35-0.90 (m, 3H); 0.96 (t, 3H, J = 7 Hz).

15

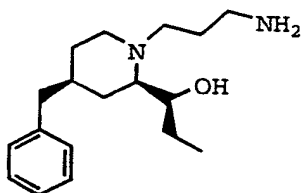

Part F: Preparation of erythro-cis-1-(3-amino-n-prop-1-yl)-4-benzyl- α -ethylpiperidinemethanol

20

Erythro-cis-4-benzyl- α -ethyl-1-(3-N-phthalimido-n-prop-1-yl)piperidinemethanol (200 mg, 0.48 mmol, 1 eq.) was dissolved in 5 mL of ethanol at 25 °C under N₂. Anhydrous hydrazine (0.03 mL, 0.95 mmol, 2 eq.) was added and the
 25 reaction refluxed for 3 hours during which time a white precipitate (phthalhydrazide) formed. Once cool, the solids were filtered. The filtrate solvent was removed *in vacuo* to yield an oil which was stirred in Et₂O. The triturated solids were filtered and the filtrate solvent
 30 was removed *in vacuo* to yield 120 mg of an oil. Yield = 87%. NMR (300 MHz, CDCl₃) δ 7.27 (t, 2H, J = 7 Hz); 7.17 (d, 1H, J = 7 Hz); 7.13 (d, 2H, J = 7 Hz); 3.70-3.30 (m, 2H); 3.20-3.00 (m, 2H); 3.00-2.70 (m, 2H); 2.70-2.40 (m, 2H);

2.30-2.10 (m, 1H); 2.10-1.90 (m, 2H); 1.90-1.40 (m, 5H);
1.40-1.00 (m, 3H); 0.96 (t, 3H, $J = 7$ Hz).

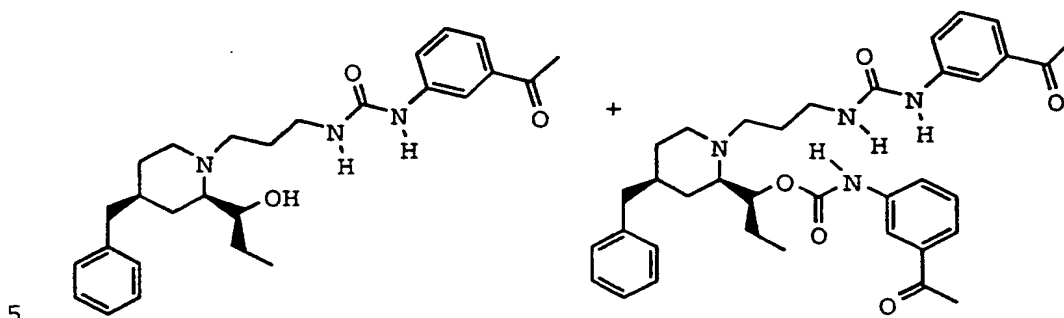

Part G: preparation of erythro-cis-1-[3-(3-
acetylphenylaminocarbonylamino)-n-prop-1-yl]-4-benzyl- α -
10 ethylpiperidinemethanol and erythro-cis-1-[3-(3-
acetylphenylaminocarbonylamino)-n-prop-1-yl]-2-[1-(3-
acetylphenylaminocarbonyloxy)-n-prop-1-yl]-4-
benzylpiperidine

15 Erythro-cis-1-(3-amino-n-prop-1-yl)-4-benzyl- α -
ethylpiperidinemethanol (120 mg, 0.41 mmol, 1 eq.) was
dissolved in 5 mL of THF at 25 °C under N_2 , then 3-
acetylphenyl isocyanate added neat. After 1 hour the
solvent was removed *in vacuo* to yield an oil. Purified by
20 flash chromatography in 100% EtOAc to 4:1 chloroform/MeOH.
Isolated mono-addition product (product A) along with an
additional bis-addition product (product B). Product A
yielded 81 mg of an oil. Yield = 43%. Product B yielded
43 mg of an oil.

25 Product A NMR (300 MHz, $CDCl_3$) δ 7.86 (bs, 1H); 7.73 (d, 1H,
 $J = 7$ Hz); 7.60 (s, 1H); 7.56 (d, 1H, $J = 7$ Hz); 7.40-7.15
(m, 4H); 7.12 (d, 2H, $J = 7$ Hz); 6.30-6.05 (m, 1H); 4.00-
3.80 (m, 1H); 3.50-3.30 (m, 1H); 3.30-2.90 (m, 5H); 2.60-
2.40 (m, 2H); 2.57 (s, 3H); 2.30-2.10 (m, 1H); 2.10-1.90

(m, 2H); 1.80-1.40 (m, 5H); 1.30-1.05 (m, 2H); 0.94 (t, 3H, J = 7 Hz).

5 Product B NMR (300 MHz, CDCl₃) δ 10.80-10.60 (m, 1H); 8.20-8.00 (m, 1H); 7.91 (bs, 1H); 7.80-7.18 (m, 9H); 7.11 (d, 2H, J = 7 Hz); 6.20-6.00 (m, 1H); 5.20-5.00 (m, 1H); 3.50-3.00 (m, 4H); 2.57 (s, 3H); 2.56 (s, 3H); 2.55-2.00 (m, 5H); 2.00-1.00 (m, 10H); 1.00-0.80 (m, 3H)

10 Product A was separated into its enantiomers employing a Daicel Chiral Pack AD column, eluting with 0.1% diethylamine in methanol. (-)-isomer $[\alpha]_D^{25}$ (c = 0.300 g/dL, MeOH) = -14.9°. (+)-isomer $[\alpha]_D^{25}$ (c = 0.290 g/dL, MeOH) = +20.2°.

15

The following compounds can be synthesized by the methods discussed previously:

TABLE 3b.

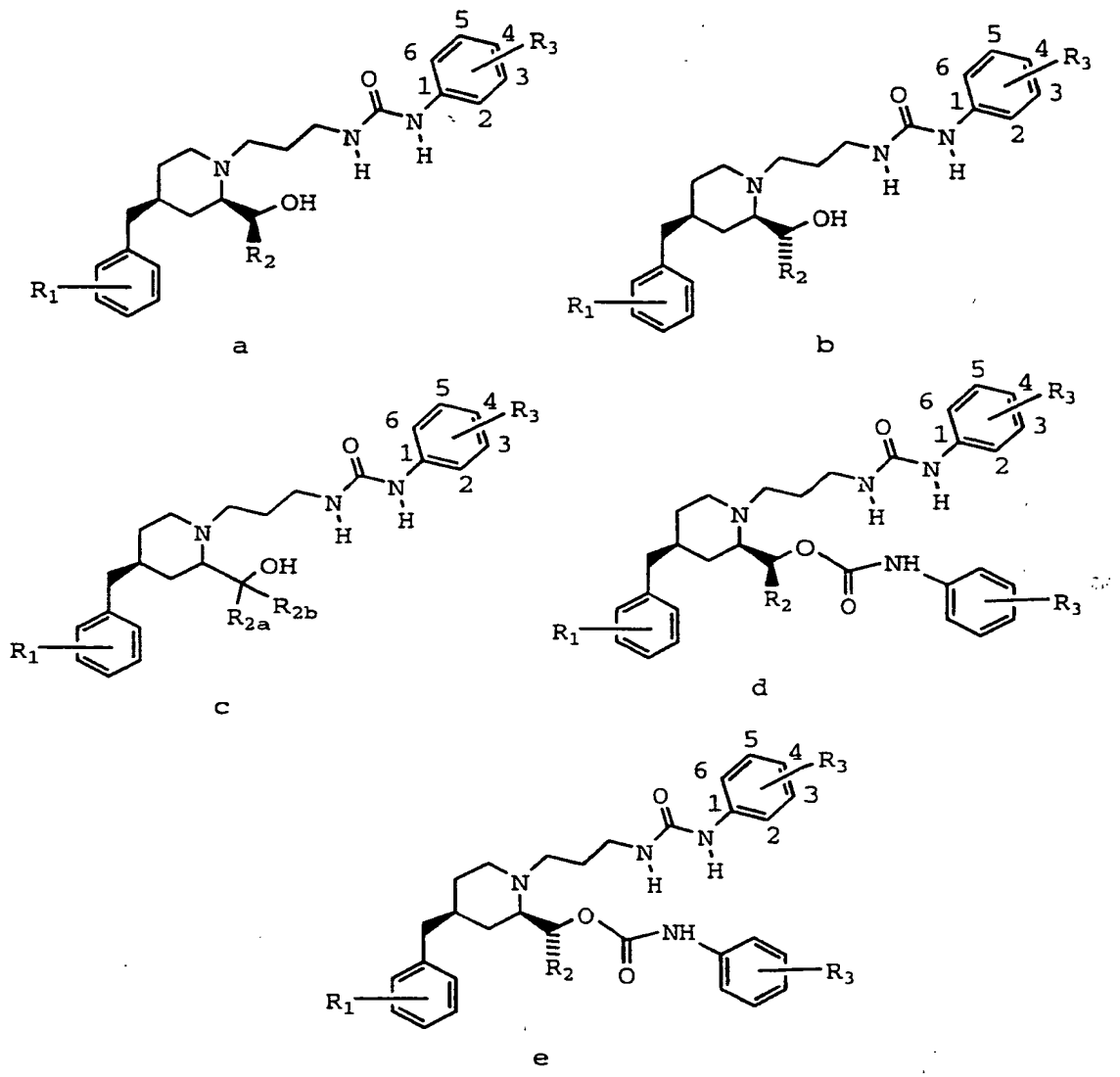

5

	Cores	R1	R2	R2a, R2b	R3	M+1
319	a, b	H	CH3	---	3-COCH3	438
320	a, b	H	CH3	---	4-NO2	441
321	a, b	H	CH3CH2	---	3-COCH3	452
322	c	H	---	CH3, CH3	3-COCH3	452
323	a, b	H	CH3CH2CH2	---	3-COCH3	466

324	a, b	H	(CH ₃) ₂ CH	---	3-COCH ₃	466
325	a, b	H	CH ₃ CH ₂ CH ₂ CH ₂	---	3-COCH ₃	480
326	a, b	H	(CH ₃) ₂ CHCH ₂	---	3-COCH ₃	480
327	d, e	H	CH ₃ CH ₂	---	3-COCH ₃	613
328	d, e	H	CH ₃ CH ₂ CH ₂	---	3-COCH ₃	627
329	d, e	H	(CH ₃) ₂ CH	---	3-COCH ₃	627
330	d, e	H	CH ₃ CH ₂ CH ₂ CH ₂	---	3-COCH ₃	641
331	d, e	H	(CH ₃) ₂ CHCH ₂	---	3-COCH ₃	641

Example 332

5 Part A Preparation of N-cyano-N'-3-methoxyphenylcarbamimidic acid, phenyl ester

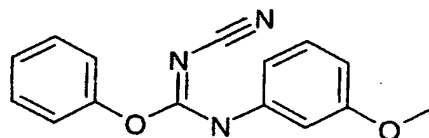

10 m-Anisidine (4.56 mL, 4.06 mmol, 1 eq.), and
diphenylcyanocarbonimidate (967 mg, 4.06 mmol, 1 eq.) were
mixed and refluxed in acetonitrile under N₂ for 1 hour.
Solids precipitated. The reaction was worked up by
filtering off the solids. Obtained 580 mg as product.
M.P. = 170.0 - 171.0 °C. NMR (300 MHz, DMSO-d₆) δ 8.70 -
15 8.50 (m, 1H); 7.43 (t, 2H, J = 7 Hz); 7.40 - 7.20 (m, 2H);
7.14 (d, 2H, J = 7 Hz); 7.00 - 6.80 (m, 2H); 6.80 - 6.70
(m, 1H); 3.80 (s, 3H).

20 Part B Preparation of N''-cyano-N'-(3-[4-(4-fluorobenzyl)piperidin]propyl)-N-(3-methoxyphenyl)guanidine

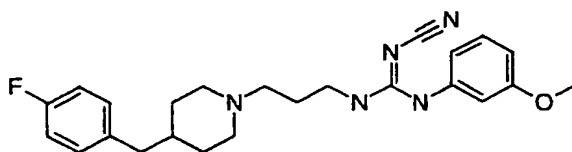

3-(4-(4-fluorophenylmethyl)piperidin-1-yl)propylamine, (synthesized in a similar fashion to the previously described des-fluoro compound) (53 mg, 0.20 mmol, 1 eq.) and the product from Part A (50 mg, 0.20 mmol, 1 eq.) were mixed and refluxed in 2-propanol under N₂ for 1 hour. The reaction was stripped and the residue then purified over silica gel in 100 % ethyl acetate followed by 8:2 chloroform/methanol. Obtained 55 mg of off-white solids as product. NMR (300 MHz, CDCl₃) δ 7.33 (t, 1H, J = 7 Hz); 7.10 - 6.90 (m, 4H); 6.90 - 6.80 (m, 3H); 3.83 (s, 3H); 3.50 - 3.35 (m, 2H); 2.90 - 2.70 (m, 2H); 1.50 - 1.20 (m, 3H). Mass Spec detects 424 (M+H).

15

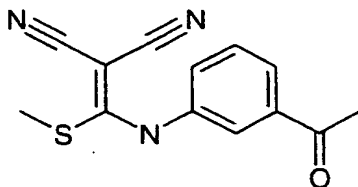
Example 334Part A: Preparation of [(Methylthio)(3-acetylphenyl amino)methylenepropanedinitrile

20 [Bis(methylthio)methylene]propanedinitrile 3.00 g, 17.6 mmol, 1 eq.), and 3'-amino-acetophenone (2.38 g, 17.6 mmol, 1 eq.), were mixed and refluxed under N₂ in ethanol for 16 hours. Solids precipitated while cooling to 25 °C. The solids were filtered. Obtained 1.86 g of tan solids. 25 M.P. = 165.0 - 166.5 °C. NMR (300 MHz, DMSO-d₆) δ 10.66 (m, 1H); 7.90 - 7.80 (m, 2H); 7.60 - 7.50 (m, 2H); 2.60 (s, 3H); 2.54 (s, 3H).

Part B: Preparation of 2-[(3-acetylanilino)((3-[4-(4-fluorobenzyl)-1-piperidinyl]propyl)amino)methylene]malononitrile

5

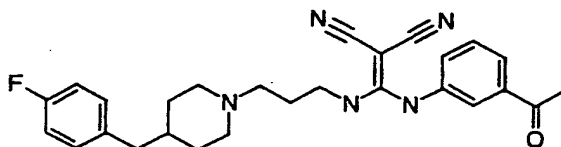

3-(4-(4-fluorophenylmethyl)piperidin-1-yl)propylamine, 49 mg, 0.194 mmol, 1 eq.) and the product from Part A (50 mg, 0.194 mmol, 1 eq.) were mixed then stirred under N₂ overnight. The reaction was stripped and the residue purified over chloroform/methanol. Obtained 17 mg of a white amorphous solid. NMR (300 MHz, CDCl₃) δ 7.82 (d, 1H, J = 7 Hz); 7.73 (s, 1H); 7.51 (t, 1H, J = 7 Hz); 7.34 (d, 1H, J = 7 Hz); 7.10-6.80 (m, 4H); 3.28 (m, 2H); 2.62 (s, 3H); 2.64-2.40 (m, 2H); 2.40-2.25 (m, 2H); 2.05-1.70 (m, 2H); 1.70-1.35 (m, 3H); 1.20-0.80 (m, 2H). Mass Spec detects 460 (M+H).

20

Example 335

Part A: Preparation of N-[1-(methylthio)-2-nitroethenyl]-3-acetylbenzenamine

25

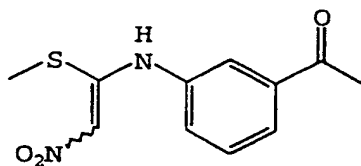

A neat mixture of 1,1-bismethylthio-2-nitroethylene (6.5 g, 38.5 mmol, 10 eq) and 3-aminoacetophenone (0.5 g, 3.85 mmol, 1eq) was melted together and heated at 140° C for four hours. The mixture was cooled to room temperature, then subjected to flash chromatography, eluting with 50%

ethyl acetate/hexanes, to yield 0.63 g of a yellow powder as product. Yield = 65%. NMR (300 MHz, CDCl₃) δ 11.82 (bs, 1H), 7.95-7.91 (m, 2H), 7.59-7.48 (m, 2H), 6.73 (s, 1H), 2.65 (s, 3H), 2.41 (s, 3H).

5

Part B: Preparation of 1-(3-(((E)-1-((-[4-(4-fluorobenzyl)-1-piperidinyl]propyl)amino)-2-nitroethyl)amino)phenyl)ethanone

10

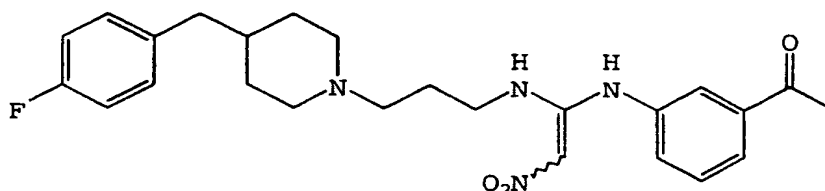

To a suspension of N-[1-(methylthio)-2-nitroethyl]-3-acetylbenzenamine (0.30 g, 1.19 mmol, 1.00 eq) in 20 ml of methanol was added 3-(4-fluorobenzyl)piperidin-1-yl)propylamine (0.31 g, 1.25 mmol, 1.05 eq), and the mixture was stirred at room temperature. After three days, a colorless solution was observed. The solvent was removed in-vacuo, and the residue was subjected to flash chromatography, eluting with 10% methanol/chloroform, to yield 0.38 g of an orange glass as product. Yield = 70%. NMR (300 MHz, CDCl₃) δ 10.51 (bs, 1H), 7.92 (d, 1H, j = 8 Hz), 7.72 (bs, 1H), 7.54 (dd, 1H, j = 8 Hz, 8 Hz), 7.35 (bd, 1H), 6.90-6.88 (m, 5H), 6.17 (s, 1H), 3.54 (bs, 2H), 2.92-2.84 (m, 2H), 2.63 (s, 3H), 2.51 (m, 2H), 1.99-1.91 (m, 4H), 1.55-1.50 (m, 3H), 0.88-0.85 (m, 2H). MS (ESI) detects (M+H)⁺ = 455.

30 The following compounds can be prepared by procedures described previously:

Table 3c

Table 3c

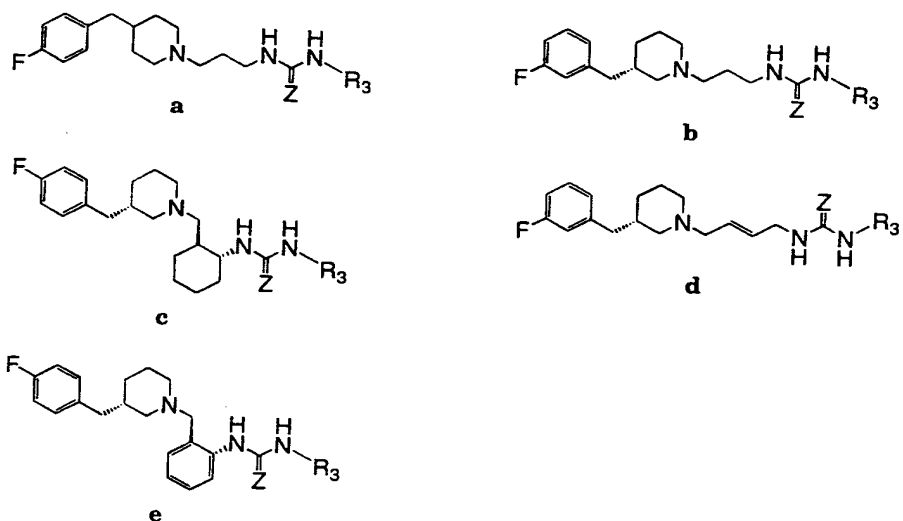

	Core	Z	R ₃	Mass Spec M+1
332	a	N-CN	3-methoxyphenyl	424
333	a	N-CN	3-acetylphenyl	460
334	a	C(CN) ₂	3-acetylphenyl	460
335	a	CHNO ₂	3-acetylphenyl	455
336	b	N-CN	3-acetylphenyl	436
337	b	C(CN) ₂	3-acetylphenyl	460
338	b	NCONH ₂	3-acetylphenyl	454
339	b	CHNO ₂	3-acetylphenyl	455
340	b	N-CN	3,5-diacetylphenyl	478
341	b	NCONH ₂	3,5-diacetylphenyl	496
342	b	NCO ₂ CH ₃	3,5-diacetylphenyl	511
343	b	C(CN) ₂	3,5-diacetylphenyl	
344	b	N-CN	3-(1-methyl-1H-tetrazol-5-yl)phenyl	476
345	b	C(CN) ₂	3-(1-methyl-1H-tetrazol-5-yl)phenyl	500
346	b	NCONH ₂	3-(1-methyl-1H-tetrazol-5-yl)phenyl	494
347	b	N-CN	2,4-dimethoxy-phenyl	454

348	b	N-CN	5-acetyl-2-methoxy-phenyl	466
349	d	N-CN	3-(1-methyl-1H-tetrazol-5-yl)phenyl	488
350	c	N-CN	phenyl	448
351	c	N-CN	3-acetylphenyl	490
352	c	N-CN	3-cyanophenyl	473
353	c	N-CN	2,4-dimethoxyphenyl	508
354	c	N-CN	2,5-dimethoxyphenyl	508
355	c	N-CN	5-acetyl-2-methoxy-phenyl	520
356	c	N-CN	2,4-dimethylphenyl	476
357	c	N-CN	4-(1-methyl-1H-tetrazol-5-yl)phenyl	530
358	c	N-CN	4-(1-propyl-1H-tetrazol-5-yl)phenyl	558
359	c	N-CN	5,6,7,8-tetrahydro-naphthy-2-yl-phenyl	502
360	c	N-CN	4-(4-morpholinyl)-phenyl	533
361	c	N-CN	2,5-dimethylphenyl	
362	c	N-CN	4-hydroxy-2-methylphenyl	
363	c	N-CN	2-methylphenyl	
364	c	N-CN	2-phenylethyl	
365	c	N-CN	1-adamantyl	
366	c	N-CN	2-adamantyl	
367	c	C(CN)2	3-acetylphenyl	514
368	c	C(CN)2	5-acetyl-2-methoxy-phenyl	544
369	c	CHNO2	3-acetylphenyl	509
370	e	CHNO2	3-acetylphenyl	560
371	e	N-CN	3,5-diacetylphenyl	583
372	e	N-CN	3-acetylphenyl	541
373	e	N-CN	4-(1-propyl-1H-tetrazol-5-yl)phenyl	581

The following tables contain representative examples of the present invention, and may be prepared by procedures described above, or methods familiar to one skilled in the art. Each entry in each table is intended to be paired with each formulae at the start of the table. For example, Entry 1 in Table 4 is intended to be paired with each of formulae 1a-44.

TABLE 4*

10

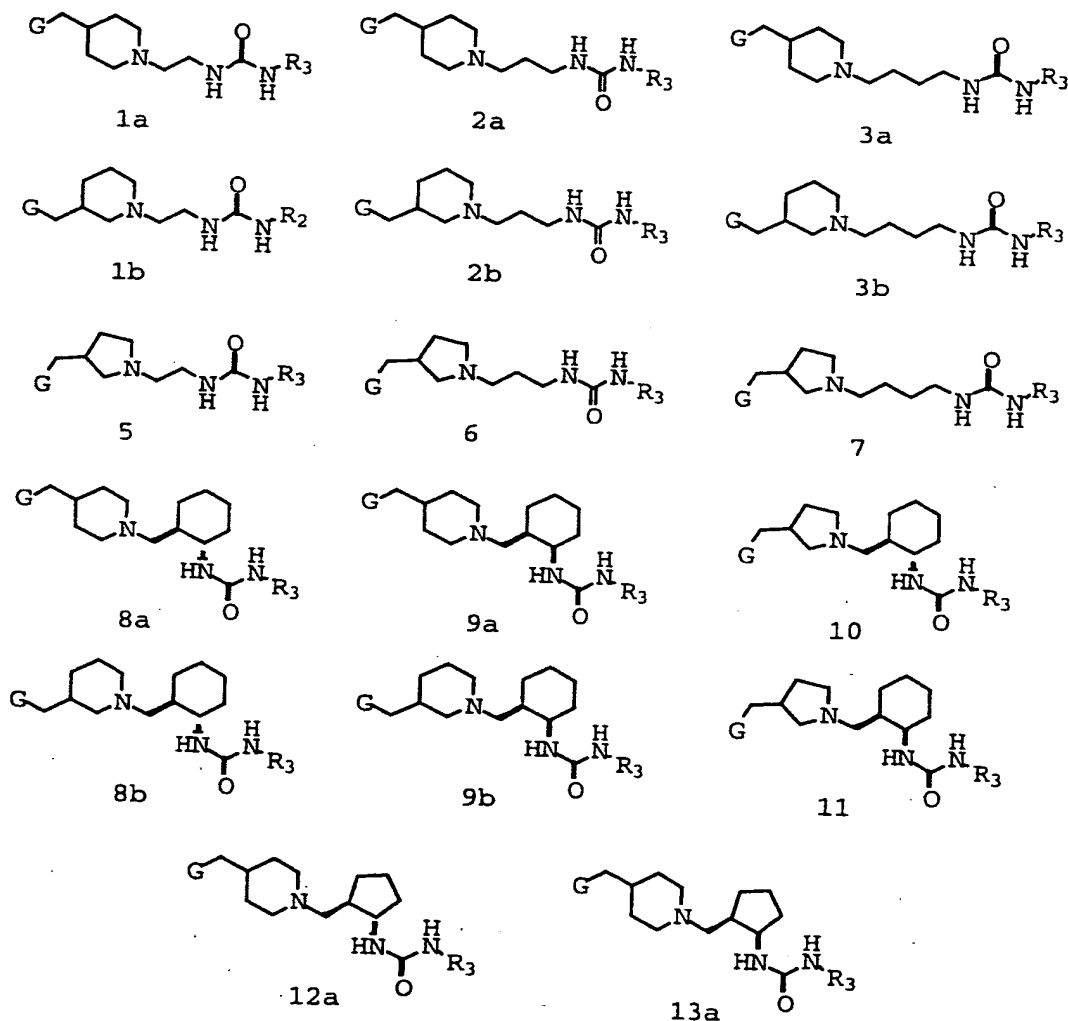

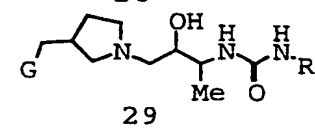
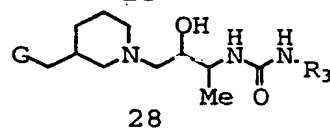
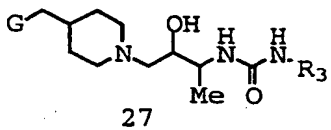
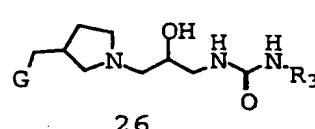
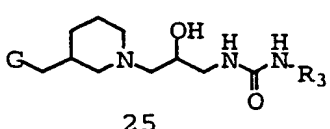
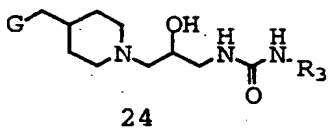
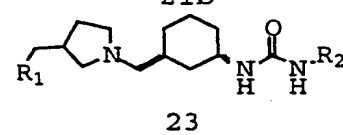
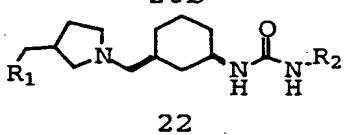
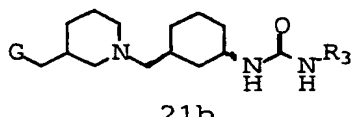
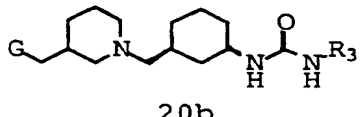
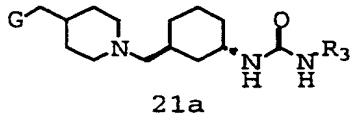
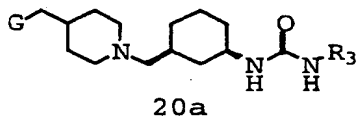
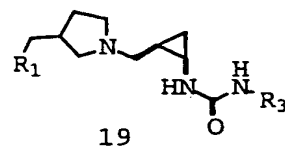
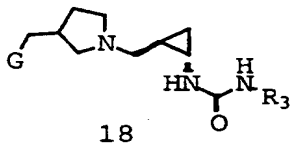
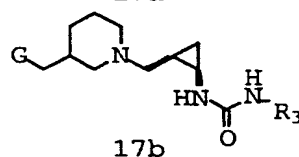
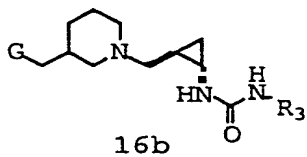
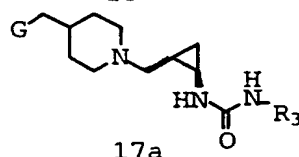
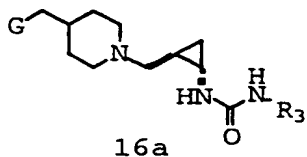
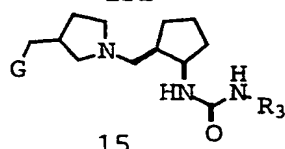
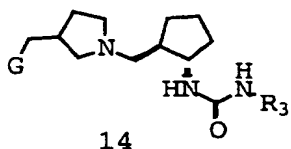
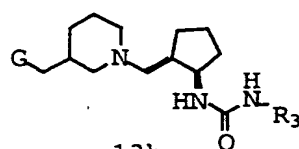
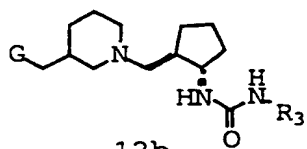

5

10

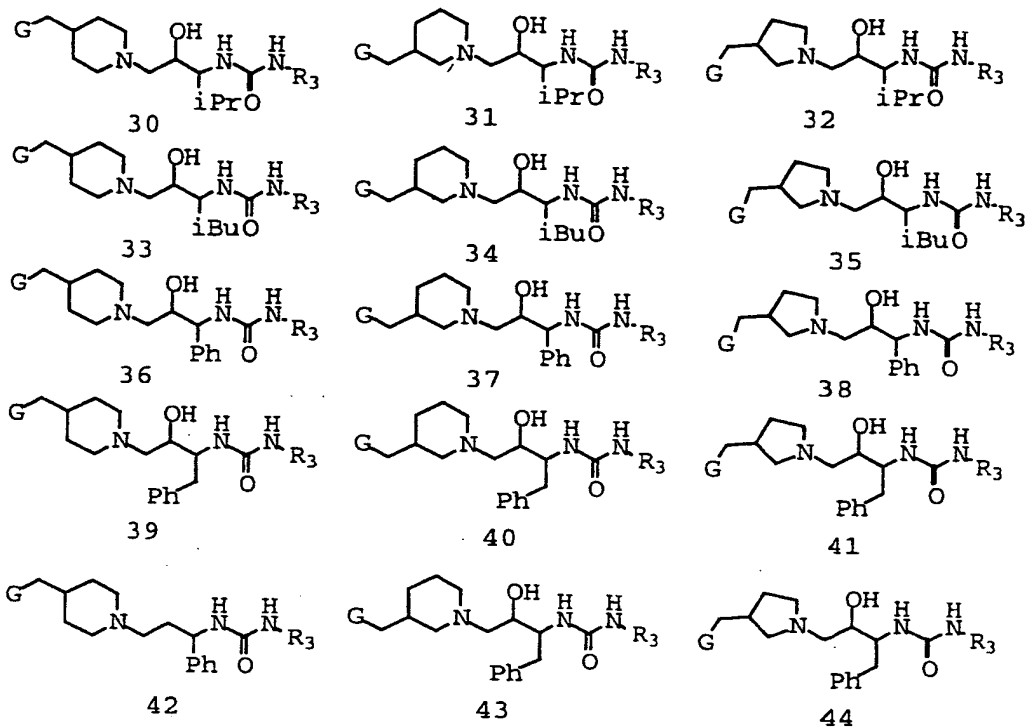

5

Entry	G	R3
1	4-F-Ph	Ph
2	4-F-Ph	3-CN-Ph
3	4-F-Ph	3-COCH3-Ph
4	4-F-Ph	3-CO2Me-Ph
5	4-F-Ph	3-CO2Et-Ph
6	4-F-Ph	3-CO2H-Ph
7	4-F-Ph	3-CONH2-Ph
8	4-F-Ph	3-CONHMe-Ph
9	4-F-Ph	3-F-Ph
10	4-F-Ph	3-Cl-Ph
11	4-F-Ph	3-Br-Ph
12	4-F-Ph	3-NO2-Ph
13	4-F-Ph	3-NH2-Ph
14	4-F-Ph	3-NHMe-Ph
15	4-F-Ph	3-NMe2-Ph
16	4-F-Ph	3-NHCOCH3-Ph
17	4-F-Ph	3-SO2NH2-Ph
18	4-F-Ph	3-SO2NHMe-Ph
19	4-F-Ph	3-CF3-Ph
20	4-F-Ph	3-OCH3-Ph
21	4-F-Ph	3-OPh-Ph
22	4-F-Ph	3-OCF3-Ph
23	4-F-Ph	3-SCH3-Ph
24	4-F-Ph	3-SOCH3-Ph
25	4-F-Ph	3-SO2CH3-Ph

26	4-F-Ph	3-OH-Ph
27	4-F-Ph	3-CH ₂ OH-Ph
28	4-F-Ph	3-CHOHCH ₃ -Ph
29	4-F-Ph	3-COH(CH ₃) ₂ -Ph
30	4-F-Ph	3-CHOHPh-Ph
31	4-F-Ph	3-CH ₃ -Ph
32	4-F-Ph	3-C ₂ H ₅ -Ph
33	4-F-Ph	3-iPr-Ph
34	4-F-Ph	3-tBu-Ph
35	4-F-Ph	3-Ph-Ph
36	4-F-Ph	3-CH ₂ Ph-Ph
37	4-F-Ph	3-CH ₂ CO ₂ Me-Ph
38	4-F-Ph	3-(1-piperidinyl)-Ph
39	4-F-Ph	3-(1-pyrrolidinyl)-Ph
40	4-F-Ph	3-(2-imidazolyl)-Ph
41	4-F-Ph	3-(1-imidazolyl)-Ph
42	4-F-Ph	3-(2-thiazolyl)-Ph
43	4-F-Ph	3-(3-pyrazolyl)-Ph
44	4-F-Ph	3-(1-pyrazolyl)-Ph
45	4-F-Ph	3-(1-tetrazolyl)-Ph
46	4-F-Ph	3-(5-tetrazolyl)-Ph
47	4-F-Ph	3-(2-pyridyl)-Ph
48	4-F-Ph	3-(2-thienyl)-Ph
49	4-F-Ph	3-(2-furanyl)-Ph
50	4-F-Ph	4-CN-Ph
51	4-F-Ph	4-COCH ₃ -Ph
52	4-F-Ph	4-CO ₂ Me-Ph
53	4-F-Ph	4-CO ₂ Et-Ph
54	4-F-Ph	4-CO ₂ H-Ph
55	4-F-Ph	4-CONH ₂ -Ph
56	4-F-Ph	4-CONHMe-Ph
57	4-F-Ph	4-CONHPh-Ph
58	4-F-Ph	4-NHCONH ₂ -Ph
59	4-F-Ph	4-F-Ph
60	4-F-Ph	4-Cl-Ph
61	4-F-Ph	4-Br-Ph
62	4-F-Ph	4-NO ₂ -Ph
63	4-F-Ph	4-NH ₂ -Ph
64	4-F-Ph	4-NHMe-Ph
65	4-F-Ph	4-NMe ₂ -Ph
66	4-F-Ph	4-NHCOCH ₃ -Ph
67	4-F-Ph	4-SO ₂ NH ₂ -Ph
68	4-F-Ph	4-SO ₂ NHMe-Ph
69	4-F-Ph	4-CF ₃ -Ph
70	4-F-Ph	4-OCH ₃ -Ph
71	4-F-Ph	4-OPh-Ph
72	4-F-Ph	4-OCF ₃ -Ph
73	4-F-Ph	4-SCH ₃ -Ph
74	4-F-Ph	4-SOCH ₃ -Ph
75	4-F-Ph	4-SO ₂ CH ₃ -Ph
76	4-F-Ph	4-OH-Ph
77	4-F-Ph	4-CH ₂ OH-Ph
78	4-F-Ph	4-CHOHCH ₃ -Ph

79	4-F-Ph	4-COH(CH ₃) ₂ -Ph
80	4-F-Ph	4-CH ₃ -Ph
81	4-F-Ph	4-C ₂ H ₅ -Ph
82	4-F-Ph	4-iPr-Ph
83	4-F-Ph	4-tBu-Ph
84	4-F-Ph	4-Ph-Ph
85	4-F-Ph	4-CH ₂ Ph-Ph
86	4-F-Ph	4-CH ₂ CO ₂ Me-Ph
87	4-F-Ph	4-(1-piperidinyl)-Ph
88	4-F-Ph	4-(1-pyrrolidinyl)-Ph
89	4-F-Ph	4-(2-imidazolyl)-Ph
90	4-F-Ph	4-(1-imidazolyl)-Ph
91	4-F-Ph	4-(2-thiazolyl)-Ph
92	4-F-Ph	4-(3-pyrazolyl)-Ph
93	4-F-Ph	4-(1-pyrazolyl)-Ph
94	4-F-Ph	4-(1-tetrazolyl)-Ph
95	4-F-Ph	4-(5-tetrazolyl)-Ph
96	4-F-Ph	4-(2-pyridyl)-Ph
97	4-F-Ph	4-(2-thienyl)-Ph
98	4-F-Ph	4-(2-furanyl)-Ph
99	4-F-Ph	2-CN-Ph
100	4-F-Ph	2-COCH ₃ -Ph
101	4-F-Ph	2-CO ₂ Me-Ph
102	4-F-Ph	2-CO ₂ Et-Ph
103	4-F-Ph	2-CO ₂ H-Ph
104	4-F-Ph	2-CONH ₂ -Ph
105	4-F-Ph	2-CONHMe-Ph
106	4-F-Ph	2-F-Ph
107	4-F-Ph	2-Cl-Ph
108	4-F-Ph	2-Br-Ph
109	4-F-Ph	2-NO ₂ -Ph
110	4-F-Ph	2-NH ₂ -Ph
111	4-F-Ph	2-NHMe-Ph
112	4-F-Ph	2-NMe ₂ -Ph
113	4-F-Ph	2-NHCOCH ₃ -Ph
114	4-F-Ph	2-SO ₂ NH ₂ -Ph
115	4-F-Ph	2-SO ₂ NHMe-Ph
116	4-F-Ph	2-CF ₃ -Ph
117	4-F-Ph	2-OCH ₃ -Ph
118	4-F-Ph	2-OPh-Ph
119	4-F-Ph	2-OCF ₃ -Ph
120	4-F-Ph	2-SCH ₃ -Ph
121	4-F-Ph	2-SOCH ₃ -Ph
122	4-F-Ph	2-SO ₂ CH ₃ -Ph
123	4-F-Ph	2-OH-Ph
124	4-F-Ph	2-CH ₂ OH-Ph
125	4-F-Ph	2-CHOHCH ₃ -Ph
126	4-F-Ph	2-COH(CH ₃) ₂ -Ph
127	4-F-Ph	2-CHOHPh-Ph
128	4-F-Ph	2-CH ₃ -Ph
129	4-F-Ph	2-C ₂ H ₅ -Ph
130	4-F-Ph	2-iPr-Ph
131	4-F-Ph	2-tBu-Ph

132	4-F-Ph	2-Ph-Ph
133	4-F-Ph	2-CH ₂ Ph-Ph
134	4-F-Ph	2-CH ₂ CO ₂ Me-Ph
135	4-F-Ph	2-(1-piperidinyl)-Ph
136	4-F-Ph	2-(1-pyrrolidinyl)-Ph
137	4-F-Ph	2-(2-imidazolyl)-Ph
138	4-F-Ph	2-(1-imidazolyl)-Ph
139	4-F-Ph	2-(2-thiazolyl)-Ph
140	4-F-Ph	2-(3-pyrazolyl)-Ph
141	4-F-Ph	2-(1-pyrazolyl)-Ph
142	4-F-Ph	2-(1-tetrazolyl)-Ph
143	4-F-Ph	2-(5-tetrazolyl)-Ph
144	4-F-Ph	2-(2-pyridyl)-Ph
145	4-F-Ph	2-(2-thienyl)-Ph
146	4-F-Ph	2-(2-furanyl)-Ph
147	4-F-Ph	2,4-diF-Ph
148	4-F-Ph	2,5-diF-Ph
149	4-F-Ph	2,6-diF-Ph
150	4-F-Ph	3,4-diF-Ph
151	4-F-Ph	3,5-diF-Ph
152	4-F-Ph	2,4-diCl-Ph
153	4-F-Ph	2,5-diCl-Ph
154	4-F-Ph	2,6-diCl-Ph
155	4-F-Ph	3,4-diCl-Ph
156	4-F-Ph	3,5-diCl-Ph
157	4-F-Ph	3,4-diCF ₃ -Ph
158	4-F-Ph	3,5-diCF ₃ -Ph
159	4-F-Ph	5-Cl-2-MeO-Ph
160	4-F-Ph	5-Cl-2-Me-Ph
161	4-F-Ph	2-F-5-Me-Ph
162	4-F-Ph	2-F-5-NO ₂ -Ph
163	4-F-Ph	3,4-OCH ₂ O-Ph
164	4-F-Ph	3,4-OCH ₂ CH ₂ O-Ph
165	4-F-Ph	2-MeO-4-Me-Ph
166	4-F-Ph	2-MeO-5-Me-Ph
167	4-F-Ph	1-naphthyl
168	4-F-Ph	2-naphthyl
169	4-F-Ph	2-thienyl
170	4-F-Ph	3-thienyl
171	4-F-Ph	2-furanyl
172	4-F-Ph	3-furanyl
173	4-F-Ph	2-pyridyl
174	4-F-Ph	3-pyridyl
175	4-F-Ph	4-pyridyl
176	4-F-Ph	2-indolyl
177	4-F-Ph	3-indolyl
178	4-F-Ph	5-indolyl
179	4-F-Ph	6-indolyl
180	4-F-Ph	3-indazolyl
181	4-F-Ph	5-indazolyl
182	4-F-Ph	6-indazolyl
183	4-F-Ph	2-imidazolyl
184	4-F-Ph	3-pyrazolyl

185	4-F-Ph	2-thiazolyl
186	4-F-Ph	5-tetrazolyl
187	4-F-Ph	2-benzimidazolyl
188	4-F-Ph	5-benzimidazolyl
189	4-F-Ph	2-benzothiazolyl
190	4-F-Ph	5-benzothiazolyl
191	4-F-Ph	2-benzoxazolyl
192	4-F-Ph	5-benzoxazolyl
193	4-F-Ph	1-adamantyl
194	4-F-Ph	2-adamantyl
195	4-F-Ph	t-Bu
196	2-F-Ph	3-CN-Ph
197	2-F-Ph	3-COCH3-Ph
198	2-F-Ph	3-CO2Me-Ph
199	2-F-Ph	3-CO2Et-Ph
200	2-F-Ph	3-CO2H-Ph
201	2-F-Ph	3-CONH2-Ph
202	2-F-Ph	3-F-Ph
203	2-F-Ph	3-Cl-Ph
204	2-F-Ph	3-NH2-Ph
205	2-F-Ph	3-SO2NH2-Ph
206	2-F-Ph	3-CF3-Ph
207	2-F-Ph	3-OCH3-Ph
208	2-F-Ph	3-OEt-Ph
209	2-F-Ph	3-OCF3-Ph
210	2-F-Ph	3-SO2CH3-Ph
211	2-F-Ph	3-OH-Ph
212	2-F-Ph	3-CH3-Ph
213	2-F-Ph	3-C2H5-Ph
214	2-F-Ph	4-CN-Ph
215	2-F-Ph	4-COCH3-Ph
216	2-F-Ph	4-CO2Me-Ph
217	2-F-Ph	4-CO2Et-Ph
218	2-F-Ph	4-CO2H-Ph
219	2-F-Ph	4-CONH2-Ph
220	2-F-Ph	4-F-Ph
221	2-F-Ph	4-Cl-Ph
222	2-F-Ph	4-NH2-Ph
223	2-F-Ph	4-SO2NH2-Ph
224	2-F-Ph	4-CF3-Ph
225	2-F-Ph	4-OCH3-Ph
226	2-F-Ph	4-OEt-Ph
227	2-F-Ph	4-OCF3-Ph
228	2-F-Ph	4-SO2CH3-Ph
229	2-F-Ph	4-OH-Ph
230	2-F-Ph	4-CH3-Ph
231	2-F-Ph	4-C2H5-Ph
232	2-F-Ph	2,4-diF-Ph
233	2-F-Ph	2,5-diF-Ph
234	2-F-Ph	3,4-diF-Ph
235	2-F-Ph	3,5-diF-Ph
236	2-F-Ph	2,4-diCl-Ph
237	2-F-Ph	2,5-diCl-Ph

238	2-F-Ph	3,4-diCl-Ph
239	2-F-Ph	3,5-diCl-Ph
240	2-F-Ph	3,4-OCH ₂ O-Ph
241	2-F-Ph	3,4-OCH ₂ CH ₂ O-Ph
242	2-F-Ph	2-thienyl
243	2-F-Ph	2-furanyl
244	2-F-Ph	2-pyridyl
245	2-F-Ph	4-pyridyl
246	2-F-Ph	2-imidazolyl
247	2-F-Ph	3-pyrazolyl
248	2-F-Ph	2-thiazolyl
249	2-F-Ph	5-tetrazolyl
250	2-F-Ph	1-adamantyl
251	2,4-diF-Ph	3-CN-Ph
252	2,4-diF-Ph	3-COCH ₃ -Ph
253	2,4-diF-Ph	3-CO ₂ Me-Ph
254	2,4-diF-Ph	3-CO ₂ Et-Ph
255	2,4-diF-Ph	3-CO ₂ H-Ph
256	2,4-diF-Ph	3-CONH ₂ -Ph
257	2,4-diF-Ph	3-F-Ph
258	2,4-diF-Ph	3-Cl-Ph
259	2,4-diF-Ph	3-NH ₂ -Ph
260	2,4-diF-Ph	3-SO ₂ NH ₂ -Ph
261	2,4-diF-Ph	3-CF ₃ -Ph
262	2,4-diF-Ph	3-OCH ₃ -Ph
263	2,4-diF-Ph	3-OEt-Ph
264	2,4-diF-Ph	3-OCF ₃ -Ph
265	2,4-diF-Ph	3-SO ₂ CH ₃ -Ph
266	2,4-diF-Ph	3-OH-Ph
267	2,4-diF-Ph	3-CH ₃ -Ph
268	2,4-diF-Ph	3-C ₂ H ₅ -Ph
269	2,4-diF-Ph	4-CN-Ph
270	2,4-diF-Ph	4-COCH ₃ -Ph
271	2,4-diF-Ph	4-CO ₂ Me-Ph
272	2,4-diF-Ph	4-CO ₂ Et-Ph
273	2,4-diF-Ph	4-CO ₂ H-Ph
274	2,4-diF-Ph	4-CONH ₂ -Ph
275	2,4-diF-Ph	4-F-Ph
276	2,4-diF-Ph	4-Cl-Ph
277	2,4-diF-Ph	4-NH ₂ -Ph
278	2,4-diF-Ph	4-SO ₂ NH ₂ -Ph
279	2,4-diF-Ph	4-CF ₃ -Ph
280	2,4-diF-Ph	4-OCH ₃ -Ph
281	2,4-diF-Ph	4-OEt-Ph
282	2,4-diF-Ph	4-OCF ₃ -Ph
283	2,4-diF-Ph	4-SO ₂ CH ₃ -Ph
284	2,4-diF-Ph	4-OH-Ph
285	2,4-diF-Ph	4-CH ₃ -Ph
286	2,4-diF-Ph	4-C ₂ H ₅ -Ph
287	2,4-diF-Ph	2,4-diF-Ph
288	2,4-diF-Ph	2,5-diF-Ph
289	2,4-diF-Ph	3,4-diF-Ph
290	2,4-diF-Ph	3,5-diF-Ph

291	2,4-diF-Ph	2,4-diCl-Ph
292	2,4-diF-Ph	2,5-diCl-Ph
293	2,4-diF-Ph	3,4-diCl-Ph
294	2,4-diF-Ph	3,5-diCl-Ph
295	2,4-diF-Ph	3,4-OCH ₂ O-Ph
296	2,4-diF-Ph	3,4-OCH ₂ CH ₂ O-Ph
297	2,4-diF-Ph	2-thienyl
298	2,4-diF-Ph	2-furanyl
299	2,4-diF-Ph	2-pyridyl
300	2,4-diF-Ph	4-pyridyl
301	2,4-diF-Ph	2-imidazolyl
302	2,4-diF-Ph	3-pyrazolyl
303	2,4-diF-Ph	2-thiazolyl
304	2,4-diF-Ph	5-tetrazolyl
305	2,4-diF-Ph	1-adamantyl
306	4-Cl-Ph	Ph
307	4-Cl-Ph	3-CN-Ph
308	4-Cl-Ph	3-COCH ₃ -Ph
309	4-Cl-Ph	3-CO ₂ Me-Ph
310	4-Cl-Ph	3-CO ₂ Et-Ph
311	4-Cl-Ph	3-CO ₂ H-Ph
312	4-Cl-Ph	3-CONH ₂ -Ph
313	4-Cl-Ph	3-CONHMe-Ph
314	4-Cl-Ph	3-F-Ph
315	4-Cl-Ph	3-Cl-Ph
316	4-Cl-Ph	3-Br-Ph
317	4-Cl-Ph	3-NO ₂ -Ph
318	4-Cl-Ph	3-NH ₂ -Ph
319	4-Cl-Ph	3-NHMe-Ph
320	4-Cl-Ph	3-NMe ₂ -Ph
321	4-Cl-Ph	3-NHCOCH ₃ -Ph
322	4-Cl-Ph	3-SO ₂ NH ₂ -Ph
323	4-Cl-Ph	3-SO ₂ NHMe-Ph
324	4-Cl-Ph	3-CF ₃ -Ph
325	4-Cl-Ph	3-OCH ₃ -Ph
326	4-Cl-Ph	3-OPh-Ph
327	4-Cl-Ph	3-OCF ₃ -Ph
328	4-Cl-Ph	3-SCH ₃ -Ph
329	4-Cl-Ph	3-SOCH ₃ -Ph
330	4-Cl-Ph	3-SO ₂ CH ₃ -Ph
331	4-Cl-Ph	3-OH-Ph
332	4-Cl-Ph	3-CH ₂ OH-Ph
333	4-Cl-Ph	3-CHOHCH ₃ -Ph
334	4-Cl-Ph	3-COH(CH ₃) ₂ -Ph
335	4-Cl-Ph	3-CHOHPh-Ph
336	4-Cl-Ph	3-CH ₃ -Ph
337	4-Cl-Ph	3-C ₂ H ₅ -Ph
338	4-Cl-Ph	3-iPr-Ph
339	4-Cl-Ph	3-tBu-Ph
340	4-Cl-Ph	3-Ph-Ph
341	4-Cl-Ph	3-CH ₂ Ph-Ph
342	4-Cl-Ph	3-CH ₂ CO ₂ Me-Ph
343	4-Cl-Ph	3-(1-piperidinyl)-Ph

344	4-Cl-Ph	3-(1-pyrrolidinyl)-Ph
345	4-Cl-Ph	3-(2-imidazolyl)-Ph
346	4-Cl-Ph	3-(1-imidazolyl)-Ph
347	4-Cl-Ph	3-(2-thiazolyl)-Ph
348	4-Cl-Ph	3-(3-pyrazolyl)-Ph
349	4-Cl-Ph	3-(1-pyrazolyl)-Ph
350	4-Cl-Ph	3-(1-tetrazolyl)-Ph
351	4-Cl-Ph	3-(5-tetrazolyl)-Ph
352	4-Cl-Ph	3-(2-pyridyl)-Ph
353	4-Cl-Ph	3-(2-thienyl)-Ph
354	4-Cl-Ph	3-(2-furanyl)-Ph
355	4-Cl-Ph	4-CN-Ph
356	4-Cl-Ph	4-COCH ₃ -Ph
357	4-Cl-Ph	4-CO ₂ Me-Ph
358	4-Cl-Ph	4-CO ₂ Et-Ph
359	4-Cl-Ph	4-CO ₂ H-Ph
360	4-Cl-Ph	4-CONH ₂ -Ph
361	4-Cl-Ph	4-CONHMe-Ph
362	4-Cl-Ph	4-CONHPh-Ph
363	4-Cl-Ph	4-NHCONH ₂ -Ph
364	4-Cl-Ph	4-F-Ph
365	4-Cl-Ph	4-Cl-Ph
366	4-Cl-Ph	4-Br-Ph
367	4-Cl-Ph	4-NO ₂ -Ph
368	4-Cl-Ph	4-NH ₂ -Ph
369	4-Cl-Ph	4-NHMe-Ph
370	4-Cl-Ph	4-NMe ₂ -Ph
371	4-Cl-Ph	4-NHCOCH ₃ -Ph
372	4-Cl-Ph	4-SO ₂ NH ₂ -Ph
373	4-Cl-Ph	4-SO ₂ NHMe-Ph
374	4-Cl-Ph	4-CF ₃ -Ph
375	4-Cl-Ph	4-OCH ₃ -Ph
376	4-Cl-Ph	4-OPh-Ph
377	4-Cl-Ph	4-OCF ₃ -Ph
378	4-Cl-Ph	4-SCH ₃ -Ph
379	4-Cl-Ph	4-SOCH ₃ -Ph
380	4-Cl-Ph	4-SO ₂ CH ₃ -Ph
381	4-Cl-Ph	4-OH-Ph
382	4-Cl-Ph	4-CH ₂ OH-Ph
383	4-Cl-Ph	4-CHOHCH ₃ -Ph
384	4-Cl-Ph	4-COH(CH ₃) ₂ -Ph
385	4-Cl-Ph	4-CH ₃ -Ph
386	4-Cl-Ph	4-C ₂ H ₅ -Ph
387	4-Cl-Ph	4-iPr-Ph
388	4-Cl-Ph	4-tBu-Ph
389	4-Cl-Ph	4-Ph-Ph
390	4-Cl-Ph	4-CH ₂ Ph-Ph
391	4-Cl-Ph	4-CH ₂ CO ₂ Me-Ph
392	4-Cl-Ph	4-(1-piperidinyl)-Ph
393	4-Cl-Ph	4-(1-pyrrolidinyl)-Ph
394	4-Cl-Ph	4-(2-imidazolyl)-Ph
395	4-Cl-Ph	4-(1-imidazolyl)-Ph
396	4-Cl-Ph	4-(2-thiazolyl)-Ph

397	4-Cl-Ph	4-(3-pyrazolyl)-Ph
398	4-Cl-Ph	4-(1-pyrazolyl)-Ph
399	4-Cl-Ph	4-(1-tetrazolyl)-Ph
400	4-Cl-Ph	4-(5-tetrazolyl)-Ph
401	4-Cl-Ph	4-(2-pyridyl)-Ph
402	4-Cl-Ph	4-(2-thienyl)-Ph
403	4-Cl-Ph	4-(2-furanyl)-Ph
404	4-Cl-Ph	2-CN-Ph
405	4-Cl-Ph	2-COCH ₃ -Ph
406	4-Cl-Ph	2-CO ₂ Me-Ph
407	4-Cl-Ph	2-CO ₂ Et-Ph
408	4-Cl-Ph	2-CO ₂ H-Ph
409	4-Cl-Ph	2-CONH ₂ -Ph
410	4-Cl-Ph	2-CONHMe-Ph
411	4-Cl-Ph	2-F-Ph
412	4-Cl-Ph	2-Cl-Ph
413	4-Cl-Ph	2-Br-Ph
414	4-Cl-Ph	2-NO ₂ -Ph
415	4-Cl-Ph	2-NH ₂ -Ph
416	4-Cl-Ph	2-NHMe-Ph
417	4-Cl-Ph	2-NMe ₂ -Ph
418	4-Cl-Ph	2-NHCOCH ₃ -Ph
419	4-Cl-Ph	2-SO ₂ NH ₂ -Ph
420	4-Cl-Ph	2-SO ₂ NHMe-Ph
421	4-Cl-Ph	2-CF ₃ -Ph
422	4-Cl-Ph	2-OCH ₃ -Ph
423	4-Cl-Ph	2-OPh-Ph
424	4-Cl-Ph	2-OCF ₃ -Ph
425	4-Cl-Ph	2-SCH ₃ -Ph
426	4-Cl-Ph	2-SOCH ₃ -Ph
427	4-Cl-Ph	2-SO ₂ CH ₃ -Ph
428	4-Cl-Ph	2-OH-Ph
429	4-Cl-Ph	2-CH ₂ OH-Ph
430	4-Cl-Ph	2-CHOHCH ₃ -Ph
431	4-Cl-Ph	2-COH(CH ₃) ₂ -Ph
432	4-Cl-Ph	2-CHOHPh-Ph
433	4-Cl-Ph	2-CH ₃ -Ph
434	4-Cl-Ph	2-C ₂ H ₅ -Ph
435	4-Cl-Ph	2-iPr-Ph
436	4-Cl-Ph	2-tBu-Ph
437	4-Cl-Ph	2-Ph-Ph
438	4-Cl-Ph	2-CH ₂ Ph-Ph
439	4-Cl-Ph	2-CH ₂ CO ₂ Me-Ph
440	4-Cl-Ph	2-(1-piperidinyl)-Ph
441	4-Cl-Ph	2-(1-pyrrolidinyl)-Ph
442	4-Cl-Ph	2-(2-imidazolyl)-Ph
443	4-Cl-Ph	2-(1-imidazolyl)-Ph
444	4-Cl-Ph	2-(2-thiazolyl)-Ph
445	4-Cl-Ph	2-(3-pyrazolyl)-Ph
446	4-Cl-Ph	2-(1-pyrazolyl)-Ph
447	4-Cl-Ph	2-(1-tetrazolyl)-Ph
448	4-Cl-Ph	2-(5-tetrazolyl)-Ph
449	4-Cl-Ph	2-(2-pyridyl)-Ph

450	4-Cl-Ph	2-(2-thienyl)-Ph
451	4-Cl-Ph	2-(2-furanyl)-Ph
452	4-Cl-Ph	2,4-diF-Ph
453	4-Cl-Ph	2,5-diF-Ph
454	4-Cl-Ph	2,6-diF-Ph
455	4-Cl-Ph	3,4-diF-Ph
456	4-Cl-Ph	3,5-diF-Ph
457	4-Cl-Ph	2,4-diCl-Ph
458	4-Cl-Ph	2,5-diCl-Ph
459	4-Cl-Ph	2,6-diCl-Ph
460	4-Cl-Ph	3,4-diCl-Ph
461	4-Cl-Ph	3,5-diCl-Ph
462	4-Cl-Ph	3,4-diCF3-Ph
463	4-Cl-Ph	3,5-diCF3-Ph
464	4-Cl-Ph	5-Cl-2-MeO-Ph
465	4-Cl-Ph	5-Cl-2-Me-Ph
466	4-Cl-Ph	2-F-5-Me-Ph
467	4-Cl-Ph	2-F-5-NO2-Ph
468	4-Cl-Ph	3,4-OCH2O-Ph
469	4-Cl-Ph	3,4-OCH2CH2O-Ph
470	4-Cl-Ph	2-MeO-4-Me-Ph
471	4-Cl-Ph	2-MeO-5-Me-Ph
472	4-Cl-Ph	1-naphthyl
473	4-Cl-Ph	2-naphthyl
474	4-Cl-Ph	2-thienyl
475	4-Cl-Ph	3-thienyl
476	4-Cl-Ph	2-furanyl
477	4-Cl-Ph	3-furanyl
478	4-Cl-Ph	2-pyridyl
479	4-Cl-Ph	3-pyridyl
480	4-Cl-Ph	4-pyridyl
481	4-Cl-Ph	2-indolyl
482	4-Cl-Ph	3-indolyl
483	4-Cl-Ph	5-indolyl
484	4-Cl-Ph	6-indolyl
485	4-Cl-Ph	3-indazolyl
486	4-Cl-Ph	5-indazolyl
487	4-Cl-Ph	6-indazolyl
488	4-Cl-Ph	2-imidazolyl
489	4-Cl-Ph	3-pyrazolyl
490	4-Cl-Ph	2-thiazolyl
491	4-Cl-Ph	5-tetrazolyl
492	4-Cl-Ph	2-benzimidazolyl
493	4-Cl-Ph	5-benzimidazolyl
494	4-Cl-Ph	2-benzothiazolyl
495	4-Cl-Ph	5-benzothiazolyl
496	4-Cl-Ph	2-benzoxazolyl
497	4-Cl-Ph	5-benzoxazolyl
498	4-Cl-Ph	1-adamantyl
499	4-Cl-Ph	2-adamantyl
500	4-Cl-Ph	t-Bu
501	2-Cl-Ph	3-CN-Ph
502	2-Cl-Ph	3-COCH3-Ph

503	2-Cl-Ph	3-CO2Me-Ph
504	2-Cl-Ph	3-CO2Et-Ph
505	2-Cl-Ph	3-CO2H-Ph
506	2-Cl-Ph	3-CONH2-Ph
507	2-Cl-Ph	3-F-Ph
508	2-Cl-Ph	3-Cl-Ph
509	2-Cl-Ph	3-NH2-Ph
510	2-Cl-Ph	3-SO2NH2-Ph
511	2-Cl-Ph	3-CF3-Ph
512	2-Cl-Ph	3-OCH3-Ph
513	2-Cl-Ph	3-OEt-Ph
514	2-Cl-Ph	3-OCF3-Ph
515	2-Cl-Ph	3-SO2CH3-Ph
516	2-Cl-Ph	3-OH-Ph
517	2-Cl-Ph	3-CH3-Ph
518	2-Cl-Ph	3-C2H5-Ph
519	2-Cl-Ph	4-CN-Ph
520	2-Cl-Ph	4-COCH3-Ph
521	2-Cl-Ph	4-CO2Me-Ph
522	2-Cl-Ph	4-CO2Et-Ph
523	2-Cl-Ph	4-CO2H-Ph
524	2-Cl-Ph	4-CONH2-Ph
525	2-Cl-Ph	4-F-Ph
526	2-Cl-Ph	4-Cl-Ph
527	2-Cl-Ph	4-NH2-Ph
528	2-Cl-Ph	4-SO2NH2-Ph
529	2-Cl-Ph	4-CF3-Ph
530	2-Cl-Ph	4-OCH3-Ph
531	2-Cl-Ph	4-OEt-Ph
532	2-Cl-Ph	4-OCF3-Ph
533	2-Cl-Ph	4-SO2CH3-Ph
534	2-Cl-Ph	4-OH-Ph
535	2-Cl-Ph	4-CH3-Ph
536	2-Cl-Ph	4-C2H5-Ph
537	2-Cl-Ph	2,4-diF-Ph
538	2-Cl-Ph	2,5-diF-Ph
539	2-Cl-Ph	3,4-diF-Ph
540	2-Cl-Ph	3,5-diF-Ph
541	2-Cl-Ph	2,4-diCl-Ph
542	2-Cl-Ph	2,5-diCl-Ph
543	2-Cl-Ph	3,4-diCl-Ph
544	2-Cl-Ph	3,5-diCl-Ph
545	2-Cl-Ph	3,4-OCH2O-Ph
546	2-Cl-Ph	3,4-OCH2CH2O-Ph
547	2-Cl-Ph	2-thienyl
548	2-Cl-Ph	2-furanyl
549	2-Cl-Ph	2-pyridyl
550	2-Cl-Ph	4-pyridyl
551	2-Cl-Ph	2-imidazolyl
552	2-Cl-Ph	3-pyrazolyl
553	2-Cl-Ph	2-thiazolyl
554	2-Cl-Ph	5-tetrazolyl
555	2-Cl-Ph	1-adamantyl

556	2,4-diCl-Ph	3-CN-Ph
557	2,4-diCl-Ph	3-COCH3-Ph
558	2,4-diCl-Ph	3-CO2Me-Ph
559	2,4-diCl-Ph	3-CO2Et-Ph
560	2,4-diCl-Ph	3-CO2H-Ph
561	2,4-diCl-Ph	3-CONH2-Ph
562	2,4-diCl-Ph	3-F-Ph
563	2,4-diCl-Ph	3-Cl-Ph
564	2,4-diCl-Ph	3-NH2-Ph
565	2,4-diCl-Ph	3-SO2NH2-Ph
566	2,4-diCl-Ph	3-CF3-Ph
567	2,4-diCl-Ph	3-OCH3-Ph
568	2,4-diCl-Ph	3-OEt-Ph
569	2,4-diCl-Ph	3-OCF3-Ph
570	2,4-diCl-Ph	3-SO2CH3-Ph
571	2,4-diCl-Ph	3-OH-Ph
572	2,4-diCl-Ph	3-CH3-Ph
573	2,4-diCl-Ph	3-C2H5-Ph
574	2,4-diCl-Ph	4-CN-Ph
575	2,4-diCl-Ph	4-COCH3-Ph
576	2,4-diCl-Ph	4-CO2Me-Ph
577	2,4-diCl-Ph	4-CO2Et-Ph
578	2,4-diCl-Ph	4-CO2H-Ph
579	2,4-diCl-Ph	4-CONH2-Ph
580	2,4-diCl-Ph	4-F-Ph
581	2,4-diCl-Ph	4-Cl-Ph
582	2,4-diCl-Ph	4-NH2-Ph
583	2,4-diCl-Ph	4-SO2NH2-Ph
584	2,4-diCl-Ph	4-CF3-Ph
585	2,4-diCl-Ph	4-OCH3-Ph
586	2,4-diCl-Ph	4-OEt-Ph
587	2,4-diCl-Ph	4-OCF3-Ph
588	2,4-diCl-Ph	4-SO2CH3-Ph
589	2,4-diCl-Ph	4-OH-Ph
590	2,4-diCl-Ph	4-CH3-Ph
591	2,4-diCl-Ph	4-C2H5-Ph
592	2,4-diCl-Ph	2,4-diF-Ph
593	2,4-diCl-Ph	2,5-diF-Ph
594	2,4-diCl-Ph	3,4-diF-Ph
595	2,4-diCl-Ph	3,5-diF-Ph
596	2,4-diCl-Ph	2,4-diCl-Ph
597	2,4-diCl-Ph	2,5-diCl-Ph
598	2,4-diCl-Ph	3,4-diCl-Ph
599	2,4-diCl-Ph	3,5-diCl-Ph
600	2,4-diCl-Ph	3,4-OCH2O-Ph
601	2,4-diCl-Ph	3,4-OCH2CH2O-Ph
602	2,4-diCl-Ph	2-thienyl
603	2,4-diCl-Ph	2-furanyl
604	2,4-diCl-Ph	2-pyridyl
605	2,4-diCl-Ph	4-pyridyl
606	2,4-diCl-Ph	2-imidazolyl
607	2,4-diCl-Ph	3-pyrazolyl
608	2,4-diCl-Ph	2-thiazolyl

609	2,4-diCl-Ph	5-tetrazolyl
610	2,4-diCl-Ph	1-adamantyl
611	3-OCH3-Ph	3-CN-Ph
612	3-OCH3-Ph	3-COCH3-Ph
613	3-OCH3-Ph	3-CO2Me-Ph
614	3-OCH3-Ph	3-CO2Et-Ph
615	3-OCH3-Ph	3-CO2H-Ph
616	3-OCH3-Ph	3-CONH2-Ph
617	3-OCH3-Ph	3-F-Ph
618	3-OCH3-Ph	3-Cl-Ph
619	3-OCH3-Ph	3-NH2-Ph
620	3-OCH3-Ph	3-SO2NH2-Ph
621	3-OCH3-Ph	3-CF3-Ph
622	3-OCH3-Ph	3-OCH3-Ph
623	3-OCH3-Ph	3-OEt-Ph
624	3-OCH3-Ph	3-OCF3-Ph
625	3-OCH3-Ph	3-SO2CH3-Ph
626	3-OCH3-Ph	3-OH-Ph
627	3-OCH3-Ph	3-CH3-Ph
628	3-OCH3-Ph	3-C2H5-Ph
629	3-OCH3-Ph	4-CN-Ph
630	3-OCH3-Ph	4-COCH3-Ph
631	3-OCH3-Ph	4-CO2Me-Ph
632	3-OCH3-Ph	4-CO2Et-Ph
633	3-OCH3-Ph	4-CO2H-Ph
634	3-OCH3-Ph	4-CONH2-Ph
635	3-OCH3-Ph	4-F-Ph
636	3-OCH3-Ph	4-Cl-Ph
637	3-OCH3-Ph	4-NH2-Ph
638	3-OCH3-Ph	4-SO2NH2-Ph
639	3-OCH3-Ph	4-CF3-Ph
640	3-OCH3-Ph	4-OCH3-Ph
641	3-OCH3-Ph	4-OEt-Ph
642	3-OCH3-Ph	4-OCF3-Ph
643	3-OCH3-Ph	4-SO2CH3-Ph
644	3-OCH3-Ph	4-OH-Ph
645	3-OCH3-Ph	4-CH3-Ph
646	3-OCH3-Ph	4-C2H5-Ph
647	3-OCH3-Ph	2,4-diF-Ph
648	3-OCH3-Ph	2,5-diF-Ph
649	3-OCH3-Ph	3,4-diF-Ph
650	3-OCH3-Ph	3,5-diF-Ph
651	3-OCH3-Ph	2,4-diCl-Ph
652	3-OCH3-Ph	2,5-diCl-Ph
653	3-OCH3-Ph	3,4-diCl-Ph
654	3-OCH3-Ph	3,5-diCl-Ph
655	3-OCH3-Ph	3,4-OCH2O-Ph
656	3-OCH3-Ph	3,4-OCH2CH2O-Ph
657	3-OCH3-Ph	2-thienyl
658	3-OCH3-Ph	2-furanyl
659	3-OCH3-Ph	2-pyridyl
660	3-OCH3-Ph	4-pyridyl
661	3-OCH3-Ph	2-imidazolyl

662	3-OCH3-Ph	3-pyrazolyl
663	3-OCH3-Ph	2-thiazolyl
664	3-OCH3-Ph	5-tetrazolyl
665	3-OCH3-Ph	1-adamantyl
666	2-thienyl	3-CN-Ph
667	2-thienyl	3-COCH3-Ph
668	2-thienyl	3-F-Ph
669	2-thienyl	3-Cl-Ph
670	2-thienyl	3-NH2-Ph
671	2-thienyl	3-OCH3-Ph
672	2-thienyl	3-OH-Ph
673	2-thienyl	4-CN-Ph
674	2-thienyl	4-COCH3-Ph
675	2-thienyl	4-F-Ph
676	2-thienyl	4-Cl-Ph
677	2-thienyl	4-NH2-Ph
678	2-thienyl	4-OCH3-Ph
679	2-thienyl	4-OH-Ph
680	2-thienyl	3,4-diF-Ph
681	2-thienyl	3,5-diF-Ph
682	2-thienyl	3,4-diCl-Ph
683	2-thienyl	3,5-diCl-Ph
684	2-thienyl	3,4-OCH2O-Ph
685	2-thienyl	3,4-OCH2CH2O-Ph
686	3-thienyl	3-CN-Ph
687	3-thienyl	3-COCH3-Ph
688	3-thienyl	3-F-Ph
689	3-thienyl	3-Cl-Ph
690	3-thienyl	3-NH2-Ph
691	3-thienyl	3-OCH3-Ph
692	3-thienyl	3-OH-Ph
693	3-thienyl	4-CN-Ph
694	3-thienyl	4-COCH3-Ph
695	3-thienyl	4-F-Ph
696	3-thienyl	4-Cl-Ph
697	3-thienyl	4-NH2-Ph
698	3-thienyl	4-OCH3-Ph
699	3-thienyl	4-OH-Ph
700	3-thienyl	3,4-diF-Ph
701	3-thienyl	3,5-diF-Ph
702	3-thienyl	3,4-diCl-Ph
703	3-thienyl	3,5-diCl-Ph
704	3-thienyl	3,4-OCH2O-Ph
705	3-thienyl	3,4-OCH2CH2O-Ph
706	2-furanyl	3-CN-Ph
707	2-furanyl	3-COCH3-Ph
708	2-furanyl	3-F-Ph
709	2-furanyl	3-Cl-Ph
710	2-furanyl	3-NH2-Ph
711	2-furanyl	3-OCH3-Ph
712	2-furanyl	3-OH-Ph
713	2-furanyl	4-CN-Ph
714	2-furanyl	4-COCH3-Ph

715	2-furanyl	4-F-Ph
716	2-furanyl	4-Cl-Ph
717	2-furanyl	4-NH ₂ -Ph
718	2-furanyl	4-OCH ₃ -Ph
719	2-furanyl	4-OH-Ph
720	2-furanyl	3,4-diF-Ph
721	2-furanyl	3,5-diF-Ph
722	2-furanyl	3,4-diCl-Ph
723	2-furanyl	3,5-diCl-Ph
724	2-furanyl	3,4-OCH ₂ O-Ph
725	2-furanyl	3,4-OCH ₂ CH ₂ O-Ph
726	3-furanyl	3-CN-Ph
727	3-furanyl	3-COCH ₃ -Ph
728	3-furanyl	3-F-Ph
729	3-furanyl	3-Cl-Ph
730	3-furanyl	3-NH ₂ -Ph
731	3-furanyl	3-OCH ₃ -Ph
732	3-furanyl	3-OH-Ph
733	3-furanyl	4-CN-Ph
734	3-furanyl	4-COCH ₃ -Ph
735	3-furanyl	4-F-Ph
736	3-furanyl	4-Cl-Ph
737	3-furanyl	4-NH ₂ -Ph
738	3-furanyl	4-OCH ₃ -Ph
739	3-furanyl	4-OH-Ph
740	3-furanyl	3,4-diF-Ph
741	3-furanyl	3,5-diF-Ph
742	3-furanyl	3,4-diCl-Ph
743	3-furanyl	3,5-diCl-Ph
744	3-furanyl	3,4-OCH ₂ O-Ph
745	3-furanyl	3,4-OCH ₂ CH ₂ O-Ph
746	2-pyridyl	3-CN-Ph
747	2-pyridyl	3-COCH ₃ -Ph
748	2-pyridyl	3-F-Ph
749	2-pyridyl	3-Cl-Ph
750	2-pyridyl	3-NH ₂ -Ph
751	2-pyridyl	3-OCH ₃ -Ph
752	2-pyridyl	3-OH-Ph
753	2-pyridyl	4-CN-Ph
754	2-pyridyl	4-COCH ₃ -Ph
755	2-pyridyl	4-F-Ph
756	2-pyridyl	4-Cl-Ph
757	2-pyridyl	4-NH ₂ -Ph
758	2-pyridyl	4-OCH ₃ -Ph
759	2-pyridyl	4-OH-Ph
760	2-pyridyl	3,4-diF-Ph
761	2-pyridyl	3,5-diF-Ph
762	2-pyridyl	3,4-diCl-Ph
763	2-pyridyl	3,5-diCl-Ph
764	2-pyridyl	3,4-OCH ₂ O-Ph
765	2-pyridyl	3,4-OCH ₂ CH ₂ O-Ph
766	3-pyridyl	3-CN-Ph
767	3-pyridyl	3-COCH ₃ -Ph

768	3-pyridyl	3-F-Ph
769	3-pyridyl	3-Cl-Ph
770	3-pyridyl	3-NH ₂ -Ph
771	3-pyridyl	3-OCH ₃ -Ph
772	3-pyridyl	3-OH-Ph
773	3-pyridyl	4-CN-Ph
774	3-pyridyl	4-COCH ₃ -Ph
775	3-pyridyl	4-F-Ph
776	3-pyridyl	4-Cl-Ph
777	3-pyridyl	4-NH ₂ -Ph
778	3-pyridyl	4-OCH ₃ -Ph
779	3-pyridyl	4-OH-Ph
780	3-pyridyl	3,4-diF-Ph
781	3-pyridyl	3,5-diF-Ph
782	3-pyridyl	3,4-diCl-Ph
783	3-pyridyl	3,5-diCl-Ph
784	3-pyridyl	3,4-OCH ₂ O-Ph
785	3-pyridyl	3,4-OCH ₂ CH ₂ O-Ph
786	4-pyridyl	3-CN-Ph
787	4-pyridyl	3-COCH ₃ -Ph
788	4-pyridyl	3-F-Ph
789	4-pyridyl	3-Cl-Ph
790	4-pyridyl	3-NH ₂ -Ph
791	4-pyridyl	3-OCH ₃ -Ph
792	4-pyridyl	3-OH-Ph
793	4-pyridyl	4-CN-Ph
794	4-pyridyl	4-COCH ₃ -Ph
795	4-pyridyl	4-F-Ph
796	4-pyridyl	4-Cl-Ph
797	4-pyridyl	4-NH ₂ -Ph
798	4-pyridyl	4-OCH ₃ -Ph
799	4-pyridyl	4-OH-Ph
800	4-pyridyl	3,4-diF-Ph
801	4-pyridyl	3,5-diF-Ph
802	4-pyridyl	3,4-diCl-Ph
803	4-pyridyl	3,5-diCl-Ph
804	4-pyridyl	3,4-OCH ₂ O-Ph
805	4-pyridyl	3,4-OCH ₂ CH ₂ O-Ph
806	3-indolyl	3-CN-Ph
807	3-indolyl	3-COCH ₃ -Ph
808	3-indolyl	3-F-Ph
809	3-indolyl	3-Cl-Ph
810	3-indolyl	3-NH ₂ -Ph
811	3-indolyl	3-OCH ₃ -Ph
812	3-indolyl	3-OH-Ph
813	3-indolyl	4-CN-Ph
814	3-indolyl	4-COCH ₃ -Ph
815	3-indolyl	4-F-Ph
816	3-indolyl	4-Cl-Ph
817	3-indolyl	4-NH ₂ -Ph
818	3-indolyl	4-OCH ₃ -Ph
819	3-indolyl	4-OH-Ph
820	3-indolyl	3,4-diF-Ph

821	3-indolyl	3,5-diF-Ph
822	3-indolyl	3,4-diCl-Ph
823	3-indolyl	3,5-diCl-Ph
824	3-indolyl	3,4-OCH ₂ O-Ph
825	3-indolyl	3,4-OCH ₂ CH ₂ O-Ph
826	5-indolyl	3-CN-Ph
827	5-indolyl	3-COCH ₃ -Ph
828	5-indolyl	3-F-Ph
829	5-indolyl	3-Cl-Ph
830	5-indolyl	3-NH ₂ -Ph
831	5-indolyl	3-OCH ₃ -Ph
832	5-indolyl	3-OH-Ph
833	5-indolyl	4-CN-Ph
834	5-indolyl	4-COCH ₃ -Ph
835	5-indolyl	4-F-Ph
836	5-indolyl	4-Cl-Ph
837	5-indolyl	4-NH ₂ -Ph
838	5-indolyl	4-OCH ₃ -Ph
839	5-indolyl	4-OH-Ph
840	5-indolyl	3,4-diF-Ph
841	5-indolyl	3,5-diF-Ph
842	5-indolyl	3,4-diCl-Ph
843	5-indolyl	3,5-diCl-Ph
844	5-indolyl	3,4-OCH ₂ O-Ph
845	5-indolyl	3,4-OCH ₂ CH ₂ O-Ph
846	5-indazolyl	3-CN-Ph
847	5-indazolyl	3-COCH ₃ -Ph
848	5-indazolyl	3-F-Ph
849	5-indazolyl	3-Cl-Ph
850	5-indazolyl	3-NH ₂ -Ph
851	5-indazolyl	3-OCH ₃ -Ph
852	5-indazolyl	3-OH-Ph
853	5-indazolyl	4-CN-Ph
854	5-indazolyl	4-COCH ₃ -Ph
855	5-indazolyl	4-F-Ph
856	5-indazolyl	4-Cl-Ph
857	5-indazolyl	4-NH ₂ -Ph
858	5-indazolyl	4-OCH ₃ -Ph
859	5-indazolyl	4-OH-Ph
860	5-indazolyl	3,4-diF-Ph
861	5-indazolyl	3,5-diF-Ph
862	5-indazolyl	3,4-diCl-Ph
863	5-indazolyl	3,5-diCl-Ph
864	5-indazolyl	3,4-OCH ₂ O-Ph
865	5-indazolyl	3,4-OCH ₂ CH ₂ O-Ph
866	5-benzimidazolyl	3-CN-Ph
867	5-benzimidazolyl	3-COCH ₃ -Ph
868	5-benzimidazolyl	3-F-Ph
869	5-benzimidazolyl	3-Cl-Ph
870	5-benzimidazolyl	3-NH ₂ -Ph
871	5-benzimidazolyl	3-OCH ₃ -Ph
872	5-benzimidazolyl	3-OH-Ph
873	5-benzimidazolyl	4-CN-Ph

874	5-benzimidazolyl	4-COCH3-Ph
875	5-benzimidazolyl	4-F-Ph
876	5-benzimidazolyl	4-Cl-Ph
877	5-benzimidazolyl	4-NH2-Ph
878	5-benzimidazolyl	4-OCH3-Ph
879	5-benzimidazolyl	4-OH-Ph
880	5-benzimidazolyl	3,4-diF-Ph
881	5-benzimidazolyl	3,5-diF-Ph
882	5-benzimidazolyl	3,4-diCl-Ph
883	5-benzimidazolyl	3,5-diCl-Ph
884	5-benzimidazolyl	3,4-OCH2O-Ph
885	5-benzimidazolyl	3,4-OCH2CH2O-Ph
886	5-benzothiazolyl	3-CN-Ph
887	5-benzothiazolyl	3-COCH3-Ph
888	5-benzothiazolyl	3-F-Ph
889	5-benzothiazolyl	3-Cl-Ph
890	5-benzothiazolyl	3-NH2-Ph
891	5-benzothiazolyl	3-OCH3-Ph
892	5-benzothiazolyl	3-OH-Ph
893	5-benzothiazolyl	4-CN-Ph
894	5-benzothiazolyl	4-COCH3-Ph
895	5-benzothiazolyl	4-F-Ph
896	5-benzothiazolyl	4-Cl-Ph
897	5-benzothiazolyl	4-NH2-Ph
898	5-benzothiazolyl	4-OCH3-Ph
899	5-benzothiazolyl	4-OH-Ph
900	5-benzothiazolyl	3,4-diF-Ph
901	5-benzothiazolyl	3,5-diF-Ph
902	5-benzothiazolyl	3,4-diCl-Ph
903	5-benzothiazolyl	3,5-diCl-Ph
904	5-benzothiazolyl	3,4-OCH2O-Ph
905	5-benzothiazolyl	3,4-OCH2CH2O-Ph
906	5-benzoxazolyl	3-CN-Ph
907	5-benzoxazolyl	3-COCH3-Ph
908	5-benzoxazolyl	3-F-Ph
909	5-benzoxazolyl	3-Cl-Ph
910	5-benzoxazolyl	3-NH2-Ph
911	5-benzoxazolyl	3-OCH3-Ph
912	5-benzoxazolyl	3-OH-Ph
913	5-benzoxazolyl	4-CN-Ph
914	5-benzoxazolyl	4-COCH3-Ph
915	5-benzoxazolyl	4-F-Ph
916	5-benzoxazolyl	4-Cl-Ph
917	5-benzoxazolyl	4-NH2-Ph
918	5-benzoxazolyl	4-OCH3-Ph
919	5-benzoxazolyl	4-OH-Ph
920	5-benzoxazolyl	3,4-diF-Ph
921	5-benzoxazolyl	3,5-diF-Ph
922	5-benzoxazolyl	3,4-diCl-Ph
923	5-benzoxazolyl	3,5-diCl-Ph
924	5-benzoxazolyl	3,4-OCH2O-Ph
925	5-benzoxazolyl	3,4-OCH2CH2O-Ph

TABLE 6*

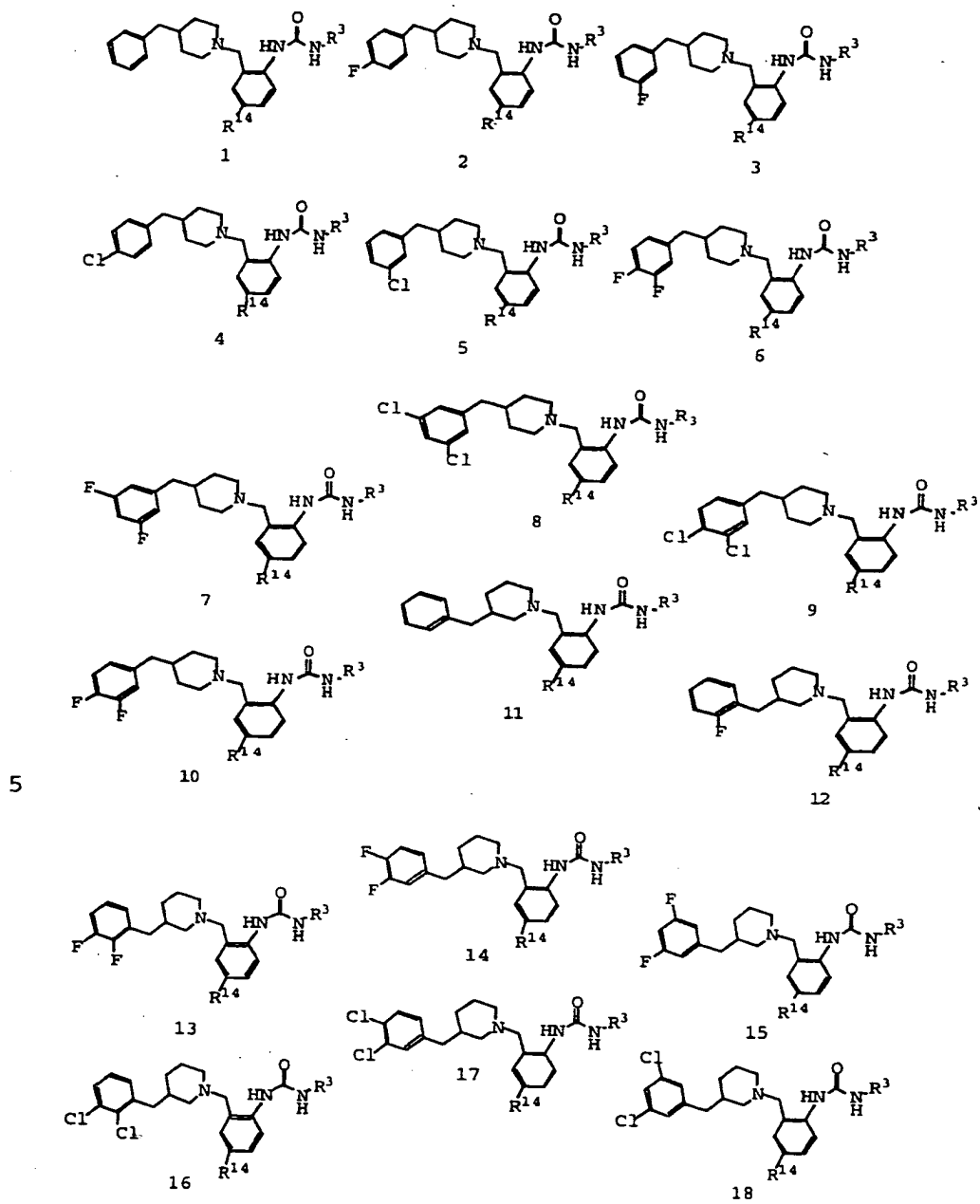

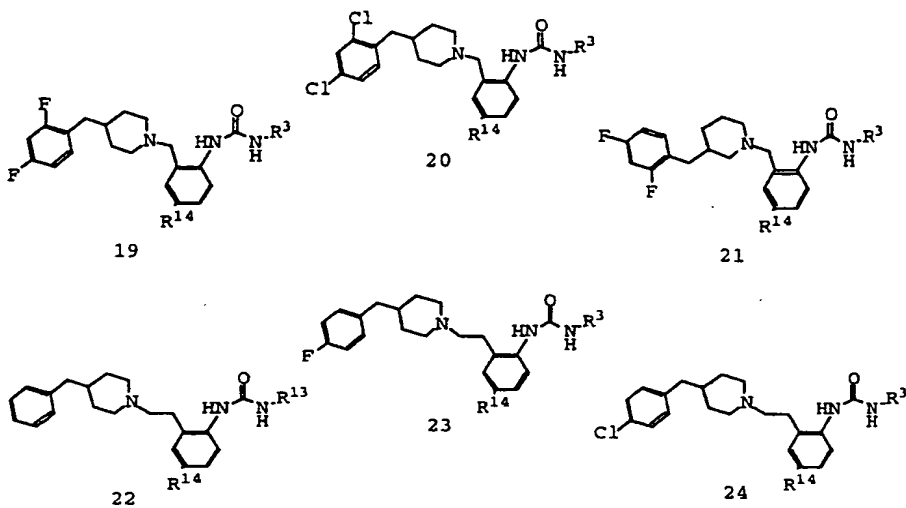

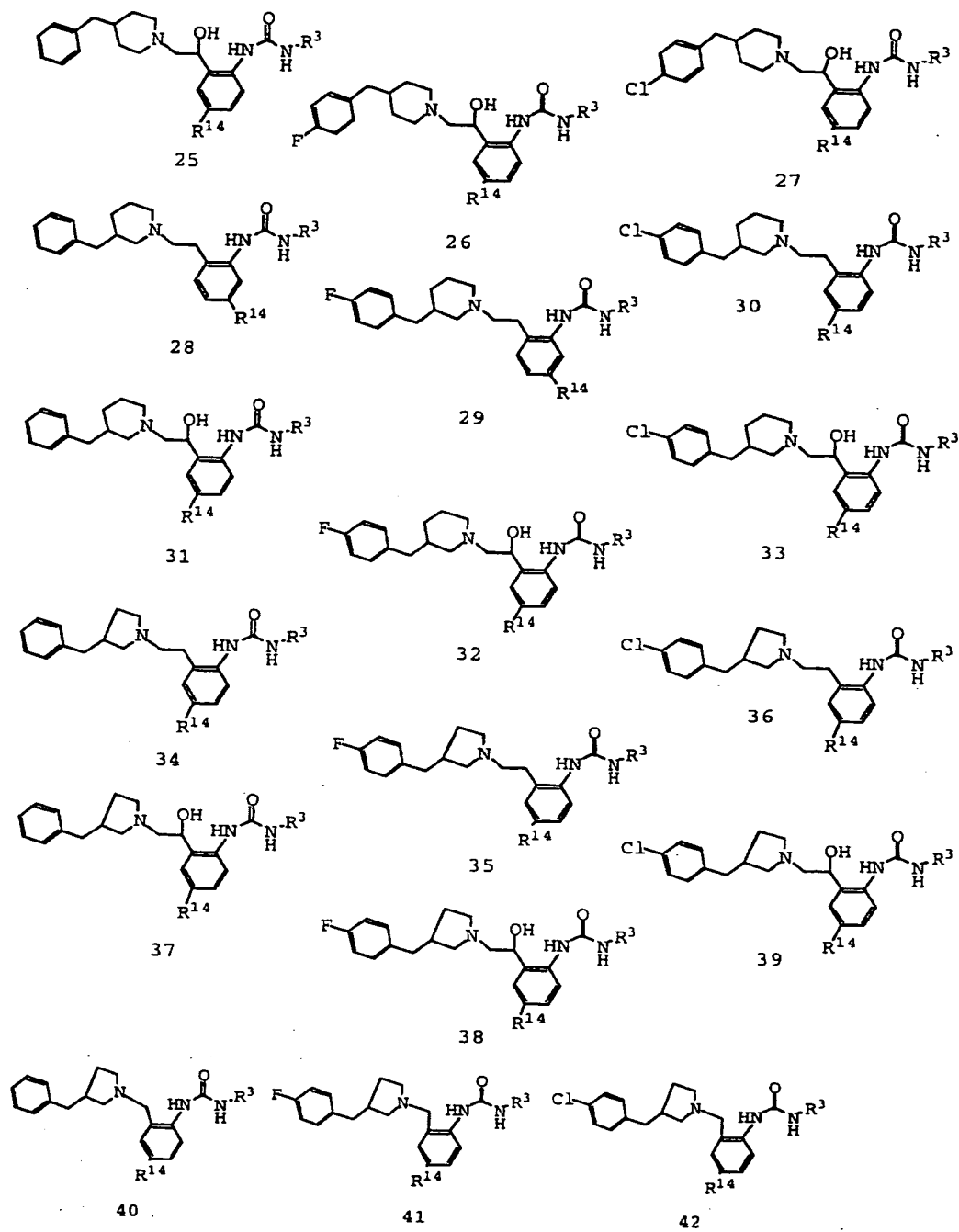

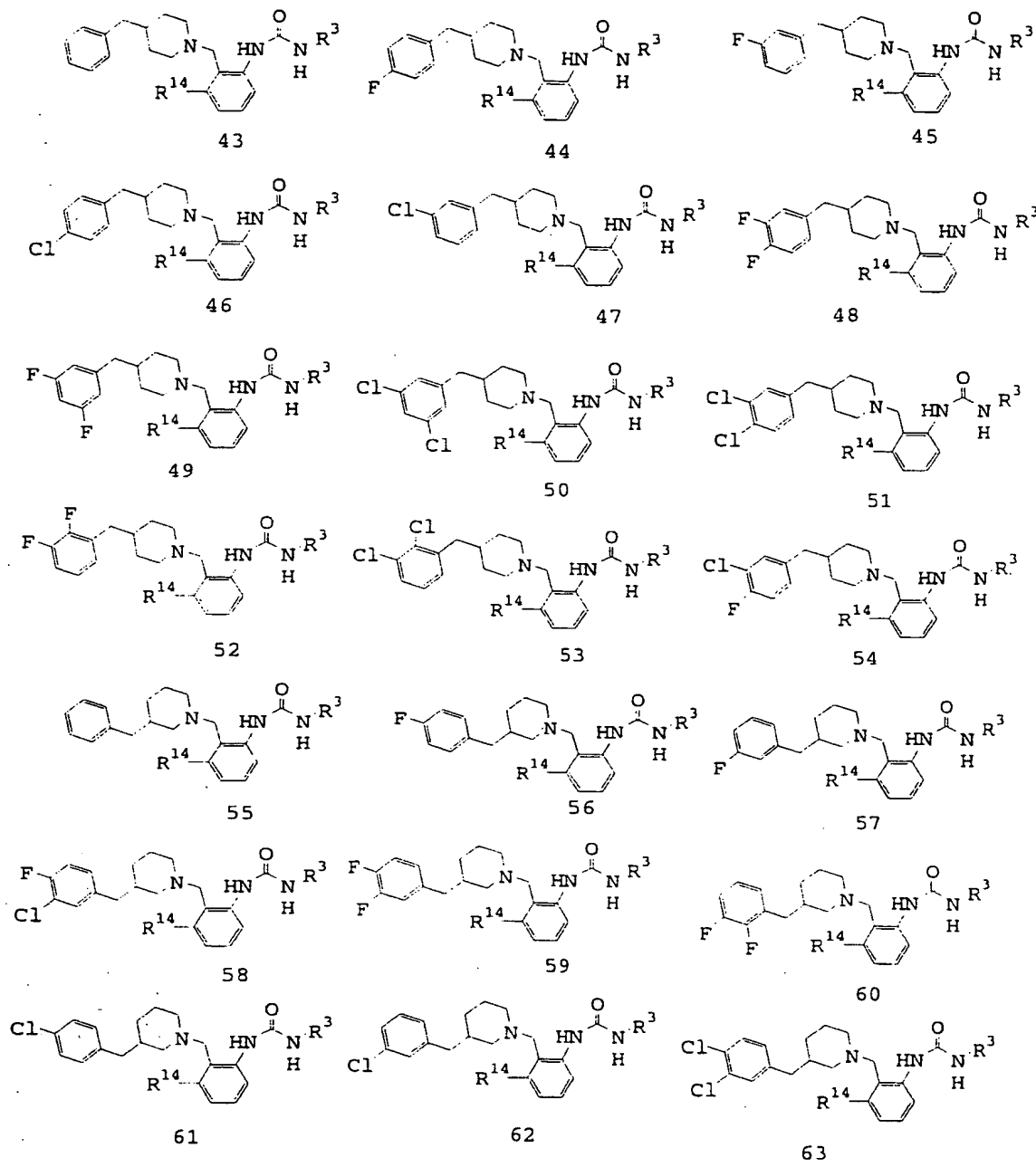

Entry	R ³	R ¹⁴
1	Ph	CN

2	Ph	F
3	Ph	Cl
4	Ph	CH ₂ OH
5	Ph	OH
6	Ph	NH ₂
7	Ph	CO ₂ Me
8	Ph	CO ₂ Et
9	Ph	CONH ₂
10	Ph	NHPh
11	Ph	NHMe
12	Ph	OMe
13	Ph	C(O) (2-imidazolyl)
14	Ph	C(O) (4-imidazolyl)
15	Ph	C(O) (2-thiazolyl)
16	Ph	C(O) (4-thiazolyl)
17	Ph	C(O) (2-oxazolyl)
18	Ph	C(O) (4-oxazolyl)
19	Ph	C(O) (3-pyrazolyl)
20	Ph	C(O) (4-pyrazolyl)
21	Ph	C(O) (5-tetrazolyl)
22	Ph	C(O) (2-pyridyl)
23	Ph	C(O) (3-pyridyl)
24	Ph	C(O) (4-pyridyl)
25	Ph	C(O) (2-thienyl)
26	Ph	C(O) (3-thienyl)
27	Ph	C(O) (2-furanyl)
28	Ph	C(O) (3-furanyl)
29	Ph	2-thienyl
30	Ph	3-thienyl
31	Ph	2-furanyl
32	Ph	3-furanyl
33	Ph	2-pyridyl
34	Ph	3-pyridyl
35	Ph	4-pyridyl
36	Ph	1-imidazolyl
37	Ph	2-imidazolyl
38	Ph	4-imidazolyl
39	Ph	1-pyrazolyl
40	Ph	3-pyrazolyl
41	Ph	4-pyrazolyl
42	Ph	2-thiazolyl
43	Ph	4-thiazolyl
44	Ph	5-tetrazolyl
45	Ph	2-oxazolyl
46	Ph	4-oxazolyl
47	Ph	C(O)N(2-imidazolyl)
48	Ph	C(O)N(4-imidazolyl)
49	Ph	C(O)N(2-thiazolyl)
50	Ph	C(O)N(4-thiazolyl)

51	Ph	C(O)N(2-oxazolyl)
52	Ph	C(O)N(4-oxazolyl)
53	Ph	C(O)N(3-pyrazolyl)
54	Ph	C(O)N(4-pyrazolyl)
55	Ph	C(O)N(2-pyridyl)
56	Ph	C(O)N(3-pyridyl)
57	Ph	C(O)N(4-pyridyl)
58	Ph	C(O)N(2-thienyl)
59	Ph	C(O)N(3-thienyl)
60	Ph	C(O)N(2-furanyl)
61	Ph	C(O)N(3-furanyl)
62	Ph	C(O)N(2-pyrrolyl)
63	Ph	C(O)N(3-pyrrolyl)
64	Ph	CH ₂ (1-imidazolyl)
65	Ph	CH ₂ (1-(1,2,3-triazolyl))
66	Ph	CH ₂ (2-(1,2,3-triazolyl))
67	Ph	CH ₂ (1-(1,2,4-triazolyl))
68	Ph	CH ₂ (1-pyrazolyl)
69	3-CN-Ph	CN
70	3-CN-Ph	F
71	3-CN-Ph	Cl
72	3-CN-Ph	CH ₂ OH
73	3-CN-Ph	OH
74	3-CN-Ph	NH ₂
75	3-CN-Ph	CO ₂ Me
76	3-CN-Ph	CO ₂ Et
77	3-CN-Ph	CONH ₂
78	3-CN-Ph	NHPh
79	3-CN-Ph	NHMe
80	3-CN-Ph	OMe
81	3-CN-Ph	C(O)(2-imidazolyl)
82	3-CN-Ph	C(O)(4-imidazolyl)
83	3-CN-Ph	C(O)(2-thiazolyl)
84	3-CN-Ph	C(O)(4-thiazolyl)
85	3-CN-Ph	C(O)(2-oxazolyl)
86	3-CN-Ph	C(O)(4-oxazolyl)
87	3-CN-Ph	C(O)(3-pyrazolyl)
88	3-CN-Ph	C(O)(4-pyrazolyl)
89	3-CN-Ph	C(O)(5-tetrazolyl)
90	3-CN-Ph	C(O)(2-pyridyl)
91	3-CN-Ph	C(O)(3-pyridyl)
92	3-CN-Ph	C(O)(4-pyridyl)
93	3-CN-Ph	C(O)(2-thienyl)
94	3-CN-Ph	C(O)(3-thienyl)
95	3-CN-Ph	C(O)(2-furanyl)
96	3-CN-Ph	C(O)(3-furanyl)
97	3-CN-Ph	2-thienyl
98	3-CN-Ph	3-thienyl
99	3-CN-Ph	2-furanyl

100	3-CN-Ph	3-furanyl
101	3-CN-Ph	2-pyridyl
102	3-CN-Ph	3-pyridyl
103	3-CN-Ph	4-pyridyl
104	3-CN-Ph	1-imidazolyl
105	3-CN-Ph	2-imidazolyl
106	3-CN-Ph	4-imidazolyl
107	3-CN-Ph	1-pyrazolyl
108	3-CN-Ph	3-pyrazolyl
109	3-CN-Ph	4-pyrazolyl
110	3-CN-Ph	2-thiazolyl
111	3-CN-Ph	4-thiazolyl
112	3-CN-Ph	5-tetrazolyl
113	3-CN-Ph	2-oxazolyl
114	3-CN-Ph	4-oxazolyl
115	3-CN-Ph	C(O)N(2-imidazolyl)
116	3-CN-Ph	C(O)N(4-imidazolyl)
117	3-CN-Ph	C(O)N(2-thiazolyl)
118	3-CN-Ph	C(O)N(4-thiazolyl)
119	3-CN-Ph	C(O)N(2-oxazolyl)
120	3-CN-Ph	C(O)N(4-oxazolyl)
121	3-CN-Ph	C(O)N(3-pyrazolyl)
122	3-CN-Ph	C(O)N(4-pyrazolyl)
123	3-CN-Ph	C(O)N(2-pyridyl)
124	3-CN-Ph	C(O)N(3-pyridyl)
125	3-CN-Ph	C(O)N(4-pyridyl)
126	3-CN-Ph	C(O)N(2-thienyl)
127	3-CN-Ph	C(O)N(3-thienyl)
128	3-CN-Ph	C(O)N(2-furanyl)
129	3-CN-Ph	C(O)N(3-furanyl)
130	3-CN-Ph	C(O)N(2-pyrrolyl)
131	3-CN-Ph	C(O)N(3-pyrrolyl)
132	3-CN-Ph	CH2(1-imidazolyl)
133	3-CN-Ph	CH2(1-(1,2,3-triazolyl))
134	3-CN-Ph	CH2(2-(1,2,3-triazolyl))
135	3-CN-Ph	CH2(1-(1,2,4-triazolyl))
136	3-CN-Ph	CH2(1-pyrazolyl)
137	3-OMe-Ph	CN
138	3-OMe-Ph	F
139	3-OMe-Ph	Cl
140	3-OMe-Ph	CH2OH
141	3-OMe-Ph	OH
142	3-OMe-Ph	NH2
143	3-OMe-Ph	CO2Me
144	3-OMe-Ph	CO2Et
145	3-OMe-Ph	CONH2
146	3-OMe-Ph	NHPh
147	3-OMe-Ph	NHMe
148	3-OMe-Ph	OMe

149	3-OMe-Ph	C(O)(2-imidazolyl)
150	3-OMe-Ph	C(O)(4-imidazolyl)
151	3-OMe-Ph	C(O)(2-thiazolyl)
152	3-OMe-Ph	C(O)(4-thiazolyl)
153	3-OMe-Ph	C(O)(2-oxazolyl)
154	3-OMe-Ph	C(O)(4-oxazolyl)
155	3-OMe-Ph	C(O)(3-pyrazolyl)
156	3-OMe-Ph	C(O)(4-pyrazolyl)
157	3-OMe-Ph	C(O)(5-tetrazolyl)
158	3-OMe-Ph	C(O)(2-pyridyl)
159	3-OMe-Ph	C(O)(3-pyridyl)
160	3-OMe-Ph	C(O)(4-pyridyl)
161	3-OMe-Ph	C(O)(2-thienyl)
162	3-OMe-Ph	C(O)(3-thienyl)
163	3-OMe-Ph	C(O)(2-furanyl)
164	3-OMe-Ph	C(O)(3-furanyl)
165	3-OMe-Ph	2-thienyl
166	3-OMe-Ph	3-thienyl
167	3-OMe-Ph	2-furanyl
168	3-OMe-Ph	3-furanyl
169	3-OMe-Ph	2-pyridyl
170	3-OMe-Ph	3-pyridyl
171	3-OMe-Ph	4-pyridyl
172	3-OMe-Ph	1-imidazolyl
173	3-OMe-Ph	2-imidazolyl
174	3-OMe-Ph	4-imidazolyl
175	3-OMe-Ph	1-pyrazolyl
176	3-OMe-Ph	3-pyrazolyl
177	3-OMe-Ph	4-pyrazolyl
178	3-OMe-Ph	2-thiazolyl
179	3-OMe-Ph	4-thiazolyl
180	3-OMe-Ph	5-tetrazolyl
181	3-OMe-Ph	2-oxazolyl
182	3-OMe-Ph	4-oxazolyl
183	3-OMe-Ph	C(O)N(2-imidazolyl)
184	3-OMe-Ph	C(O)N(4-imidazolyl)
185	3-OMe-Ph	C(O)N(2-thiazolyl)
186	3-OMe-Ph	C(O)N(4-thiazolyl)
187	3-OMe-Ph	C(O)N(2-oxazolyl)
188	3-OMe-Ph	C(O)N(4-oxazolyl)
189	3-OMe-Ph	C(O)N(3-pyrazolyl)
190	3-OMe-Ph	C(O)N(4-pyrazolyl)
191	3-OMe-Ph	C(O)N(2-pyridyl)
192	3-OMe-Ph	C(O)N(3-pyridyl)
193	3-OMe-Ph	C(O)N(4-pyridyl)
194	3-OMe-Ph	C(O)N(2-thienyl)
195	3-OMe-Ph	C(O)N(3-thienyl)
196	3-OMe-Ph	C(O)N(2-furanyl)
197	3-OMe-Ph	C(O)N(3-furanyl)

198	3-OMe-Ph	C(O)N(2-pyrrolyl)
199	3-OMe-Ph	C(O)N(3-pyrrolyl)
200	3-OMe-Ph	CH2(1-imidazolyl)
201	3-OMe-Ph	CH2(1-(1,2,3-triazolyl))
202	3-OMe-Ph	CH2(2-(1,2,3-triazolyl))
203	3-OMe-Ph	CH2(1-(1,2,4-triazolyl))
204	3-OMe-Ph	CH2(1-pyrazolyl)
205	3-C(O)Me-Ph	CN
206	3-C(O)Me-Ph	F
207	3-C(O)Me-Ph	Cl
208	3-C(O)Me-Ph	CH2OH
209	3-C(O)Me-Ph	OH
210	3-C(O)Me-Ph	NH2
211	3-C(O)Me-Ph	CO2Me
212	3-C(O)Me-Ph	CO2Et
213	3-C(O)Me-Ph	CONH2
214	3-C(O)Me-Ph	NHPh
215	3-C(O)Me-Ph	NHMe
216	3-C(O)Me-Ph	OMe
217	3-C(O)Me-Ph	C(O)(2-imidazolyl)
218	3-C(O)Me-Ph	C(O)(4-imidazolyl)
219	3-C(O)Me-Ph	C(O)(2-thiazolyl)
220	3-C(O)Me-Ph	C(O)(4-thiazolyl)
221	3-C(O)Me-Ph	C(O)(2-oxazolyl)
222	3-C(O)Me-Ph	C(O)(4-oxazolyl)
223	3-C(O)Me-Ph	C(O)(3-pyrazolyl)
224	3-C(O)Me-Ph	C(O)(4-pyrazolyl)
225	3-C(O)Me-Ph	C(O)(5-tetrazolyl)
226	3-C(O)Me-Ph	C(O)(2-pyridyl)
227	3-C(O)Me-Ph	C(O)(3-pyridyl)
228	3-C(O)Me-Ph	C(O)(4-pyridyl)
229	3-C(O)Me-Ph	C(O)(2-thienyl)
230	3-C(O)Me-Ph	C(O)(3-thienyl)
231	3-C(O)Me-Ph	C(O)(2-furanyl)
232	3-C(O)Me-Ph	C(O)(3-furanyl)
233	3-C(O)Me-Ph	2-thienyl
234	3-C(O)Me-Ph	3-thienyl
235	3-C(O)Me-Ph	2-furanyl
236	3-C(O)Me-Ph	3-furanyl
237	3-C(O)Me-Ph	2-pyridyl
238	3-C(O)Me-Ph	3-pyridyl
239	3-C(O)Me-Ph	4-pyridyl
240	3-C(O)Me-Ph	1-imidazolyl
241	3-C(O)Me-Ph	2-imidazolyl
242	3-C(O)Me-Ph	4-imidazolyl
243	3-C(O)Me-Ph	1-pyrazolyl
244	3-C(O)Me-Ph	3-pyrazolyl
245	3-C(O)Me-Ph	4-pyrazolyl
246	3-C(O)Me-Ph	2-thiazolyl

247	3-C(O)Me-Ph	4-thiazolyl
248	3-C(O)Me-Ph	5-tetrazolyl
249	3-C(O)Me-Ph	2-oxazolyl
250	3-C(O)Me-Ph	4-oxazolyl
251	3-C(O)Me-Ph	C(O)N(2-imidazolyl)
252	3-C(O)Me-Ph	C(O)N(4-imidazolyl)
253	3-C(O)Me-Ph	C(O)N(2-thiazolyl)
254	3-C(O)Me-Ph	C(O)N(4-thiazolyl)
255	3-C(O)Me-Ph	C(O)N(2-oxazolyl)
256	3-C(O)Me-Ph	C(O)N(4-oxazolyl)
257	3-C(O)Me-Ph	C(O)N(3-pyrazolyl)
258	3-C(O)Me-Ph	C(O)N(4-pyrazolyl)
259	3-C(O)Me-Ph	C(O)N(2-pyridyl)
260	3-C(O)Me-Ph	C(O)N(3-pyridyl)
261	3-C(O)Me-Ph	C(O)N(4-pyridyl)
262	3-C(O)Me-Ph	C(O)N(2-thienyl)
263	3-C(O)Me-Ph	C(O)N(3-thienyl)
264	3-C(O)Me-Ph	C(O)N(2-furanyl)
265	3-C(O)Me-Ph	C(O)N(3-furanyl)
266	3-C(O)Me-Ph	C(O)N(2-pyrrolyl)
267	3-C(O)Me-Ph	C(O)N(3-pyrrolyl)
268	3-C(O)Me-Ph	CH2(1-imidazolyl)
269	3-C(O)Me-Ph	CH2(1-(1,2,3-triazolyl))
270	3-C(O)Me-Ph	CH2(2-(1,2,3-triazolyl))
271	3-C(O)Me-Ph	CH2(1-(1,2,4-triazolyl))
272	3-C(O)Me-Ph	CH2(1-pyrazolyl)
273	4-F-Ph	CN
274	4-F-Ph	F
275	4-F-Ph	Cl
276	4-F-Ph	CH2OH
277	4-F-Ph	OH
278	4-F-Ph	NH2
279	4-F-Ph	CO2Me
280	4-F-Ph	CO2Et
281	4-F-Ph	CONH2
282	4-F-Ph	NHPh
283	4-F-Ph	NHMe
284	4-F-Ph	OMe
285	4-F-Ph	C(O)(2-imidazolyl)
286	4-F-Ph	C(O)(4-imidazolyl)
287	4-F-Ph	C(O)(2-thiazolyl)
288	4-F-Ph	C(O)(4-thiazolyl)
289	4-F-Ph	C(O)(2-oxazolyl)
290	4-F-Ph	C(O)(4-oxazolyl)
291	4-F-Ph	C(O)(3-pyrazolyl)
292	4-F-Ph	C(O)(4-pyrazolyl)
293	4-F-Ph	C(O)(5-tetrazolyl)
294	4-F-Ph	C(O)(2-pyridyl)
295	4-F-Ph	C(O)(3-pyridyl)

296	4-F-Ph	C(O) (4-pyridyl)
297	4-F-Ph	C(O) (2-thienyl)
298	4-F-Ph	C(O) (3-thienyl)
299	4-F-Ph	C(O) (2-furanyl)
300	4-F-Ph	C(O) (3-furanyl)
301	4-F-Ph	2-thienyl
302	4-F-Ph	3-thienyl
303	4-F-Ph	2-furanyl
304	4-F-Ph	3-furanyl
305	4-F-Ph	2-pyridyl
306	4-F-Ph	3-pyridyl
307	4-F-Ph	4-pyridyl
308	4-F-Ph	1-imidazolyl
309	4-F-Ph	2-imidazolyl
310	4-F-Ph	4-imidazolyl
311	4-F-Ph	1-pyrazolyl
312	4-F-Ph	3-pyrazolyl
313	4-F-Ph	4-pyrazolyl
314	4-F-Ph	2-thiazolyl
315	4-F-Ph	4-thiazolyl
316	4-F-Ph	5-tetrazolyl
317	4-F-Ph	2-oxazolyl
318	4-F-Ph	4-oxazolyl
319	4-F-Ph	C(O)N(2-imidazolyl)
320	4-F-Ph	C(O)N(4-imidazolyl)
321	4-F-Ph	C(O)N(2-thiazolyl)
322	4-F-Ph	C(O)N(4-thiazolyl)
323	4-F-Ph	C(O)N(2-oxazolyl)
324	4-F-Ph	C(O)N(4-oxazolyl)
325	4-F-Ph	C(O)N(3-pyrazolyl)
326	4-F-Ph	C(O)N(4-pyrazolyl)
327	4-F-Ph	C(O)N(2-pyridyl)
328	4-F-Ph	C(O)N(3-pyridyl)
329	4-F-Ph	C(O)N(4-pyridyl)
330	4-F-Ph	C(O)N(2-thienyl)
331	4-F-Ph	C(O)N(3-thienyl)
332	4-F-Ph	C(O)N(2-furanyl)
333	4-F-Ph	C(O)N(3-furanyl)
334	4-F-Ph	C(O)N(2-pyrrolyl)
335	4-F-Ph	C(O)N(3-pyrrolyl)
336	4-F-Ph	CH2 (1-imidazolyl)
337	4-F-Ph	CH2 (1- (1, 2, 3-triazolyl))
338	4-F-Ph	CH2 (2- (1, 2, 3-triazolyl))
339	4-F-Ph	CH2 (1- (1, 2, 4-triazolyl))
340	4-F-Ph	CH2 (1-pyrazolyl)

Table 7.

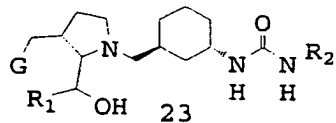
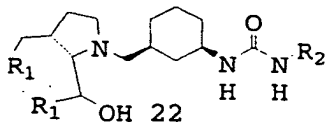
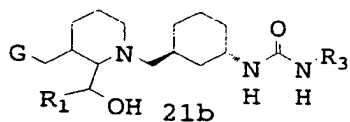
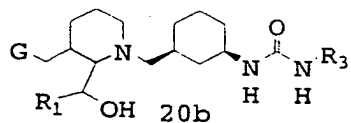
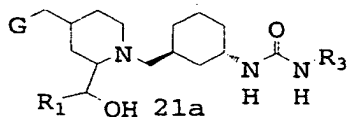
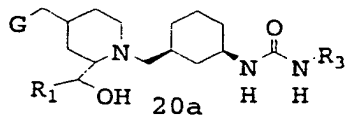
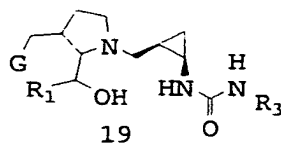
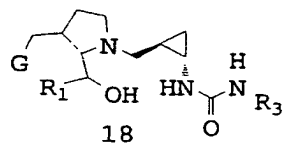
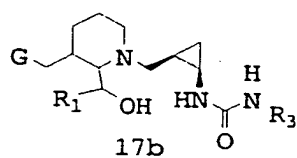
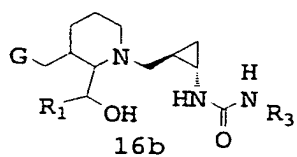
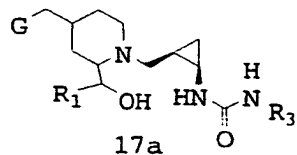
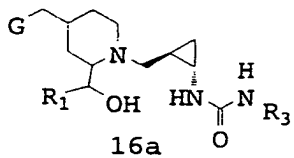
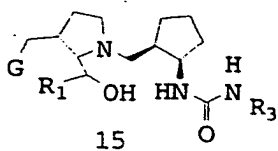
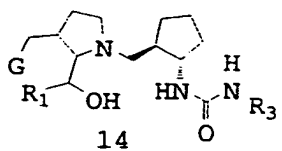

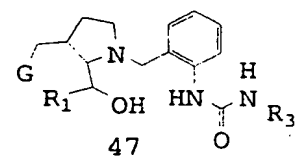
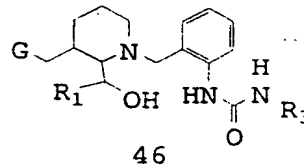
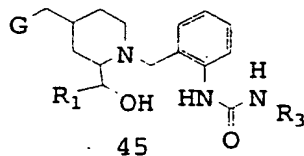
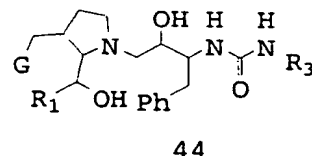
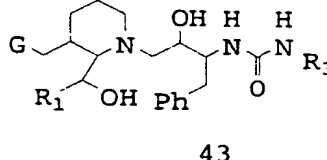
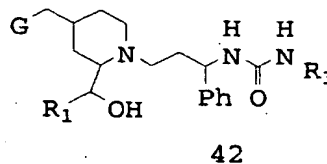
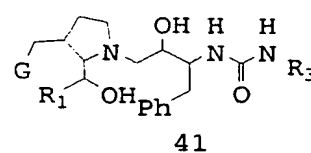
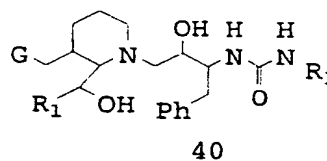
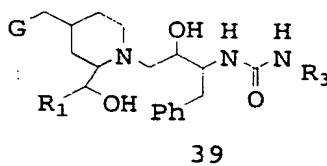
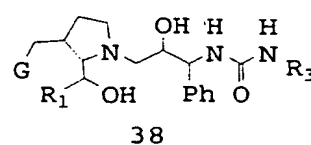
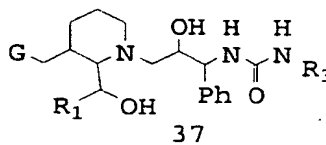
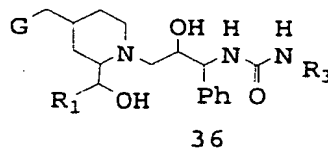
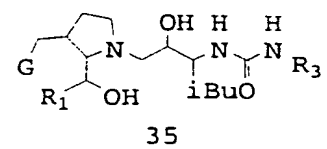
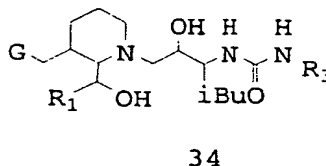
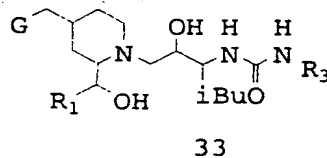
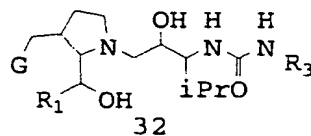
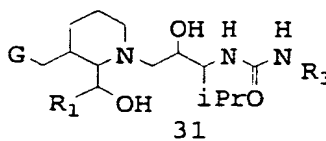
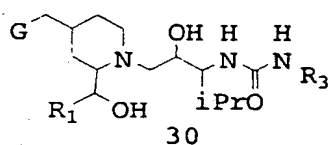
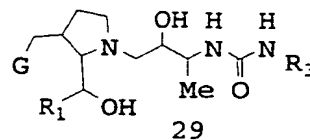
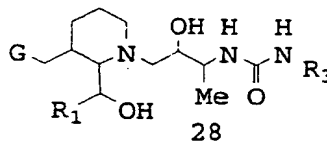
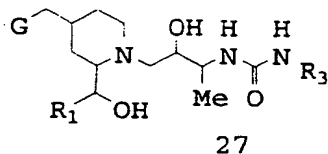
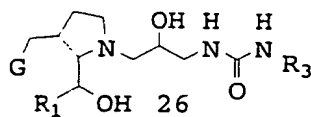
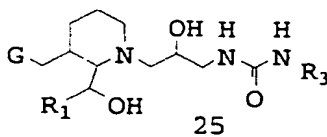
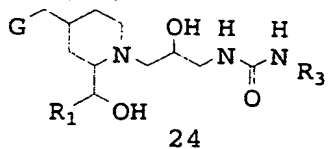

R1 = a) H, b) methyl, c) ethyl, d) n-propyl, e) allyl, f) n-butyl, g) n-pentyl, and h) n-hexyl.

Entry	G	R3
1	4-F-Ph	Ph
2	4-F-Ph	3-CN-Ph
3	4-F-Ph	3-COCH3-Ph
4	4-F-Ph	3-CO2Me-Ph
5	4-F-Ph	3-CO2Et-Ph
6	4-F-Ph	3-CO2H-Ph
7	4-F-Ph	3-CONH2-Ph
8	4-F-Ph	3-CONHMe-Ph
9	4-F-Ph	3-F-Ph
10	4-F-Ph	3-Cl-Ph
11	4-F-Ph	3-Br-Ph
12	4-F-Ph	3-NO2-Ph
13	4-F-Ph	3-NH2-Ph
14	4-F-Ph	3-NHMe-Ph
15	4-F-Ph	3-NMe2-Ph
16	4-F-Ph	3-NHCOCH3-Ph
17	4-F-Ph	3-SO2NH2-Ph
18	4-F-Ph	3-SO2NHMe-Ph
19	4-F-Ph	3-CF3-Ph
20	4-F-Ph	3-OCH3-Ph
21	4-F-Ph	3-OPh-Ph
22	4-F-Ph	3-OCF3-Ph
23	4-F-Ph	3-SCH3-Ph
24	4-F-Ph	3-SOCH3-Ph
25	4-F-Ph	3-SO2CH3-Ph
26	4-F-Ph	3-OH-Ph
27	4-F-Ph	3-CH2OH-Ph
28	4-F-Ph	3-CHOHCH3-Ph
29	4-F-Ph	3-COH(CH3)2-Ph
30	4-F-Ph	3-CHOHPh-Ph
31	4-F-Ph	3-CH3-Ph
32	4-F-Ph	3-C2H5-Ph
33	4-F-Ph	3-iPr-Ph
34	4-F-Ph	3-tBu-Ph
35	4-F-Ph	3-Ph-Ph
36	4-F-Ph	3-CH2Ph-Ph
37	4-F-Ph	3-CH2CO2Me-Ph
38	4-F-Ph	3-(1-piperidinyl)-Ph
39	4-F-Ph	3-(1-pyrrolidinyl)-Ph
40	4-F-Ph	3-(2-imidazolyl)-Ph
41	4-F-Ph	3-(1-imidazolyl)-Ph
42	4-F-Ph	3-(2-thiazolyl)-Ph
43	4-F-Ph	3-(3-pyrazolyl)-Ph
44	4-F-Ph	3-(1-pyrazolyl)-Ph
45	4-F-Ph	3-(1-tetrazolyl)-Ph
46	4-F-Ph	3-(5-tetrazolyl)-Ph
47	4-F-Ph	3-(2-pyridyl)-Ph
48	4-F-Ph	3-(2-thienyl)-Ph

49	4-F-Ph	3-(2-furanyl)-Ph
50	4-F-Ph	4-CN-Ph
51	4-F-Ph	4-COCH3-Ph
52	4-F-Ph	4-CO2Me-Ph
53	4-F-Ph	4-CO2Et-Ph
54	4-F-Ph	4-CO2H-Ph
55	4-F-Ph	4-CONH2-Ph
56	4-F-Ph	4-CONHMe-Ph
57	4-F-Ph	4-CONHPh-Ph
58	4-F-Ph	4-NHCONH2-Ph
59	4-F-Ph	4-F-Ph
60	4-F-Ph	4-Cl-Ph
61	4-F-Ph	4-Br-Ph
62	4-F-Ph	4-NO2-Ph
63	4-F-Ph	4-NH2-Ph
64	4-F-Ph	4-NHMe-Ph
65	4-F-Ph	4-NMe2-Ph
66	4-F-Ph	4-NHCOCH3-Ph
67	4-F-Ph	4-SO2NH2-Ph
68	4-F-Ph	4-SO2NHMe-Ph
69	4-F-Ph	4-CF3-Ph
70	4-F-Ph	4-OCH3-Ph
71	4-F-Ph	4-OPh-Ph
72	4-F-Ph	4-OCF3-Ph
73	4-F-Ph	4-SCH3-Ph
74	4-F-Ph	4-SOCH3-Ph
75	4-F-Ph	4-SO2CH3-Ph
76	4-F-Ph	4-OH-Ph
77	4-F-Ph	4-CH2OH-Ph
78	4-F-Ph	4-CHOHCH3-Ph
79	4-F-Ph	4-COH(CH3)2-Ph
80	4-F-Ph	4-CH3-Ph
81	4-F-Ph	4-C2H5-Ph
82	4-F-Ph	4-iPr-Ph
83	4-F-Ph	4-tBu-Ph
84	4-F-Ph	4-Ph-Ph
85	4-F-Ph	4-CH2Ph-Ph
86	4-F-Ph	4-CH2CO2Me-Ph
87	4-F-Ph	4-(1-piperidinyl)-Ph
88	4-F-Ph	4-(1-pyrrolidinyl)-Ph
89	4-F-Ph	4-(2-imidazolyl)-Ph
90	4-F-Ph	4-(1-imidazolyl)-Ph
91	4-F-Ph	4-(2-thiazolyl)-Ph
92	4-F-Ph	4-(3-pyrazolyl)-Ph
93	4-F-Ph	4-(1-pyrazolyl)-Ph
94	4-F-Ph	4-(1-tetrazolyl)-Ph
95	4-F-Ph	4-(5-tetrazolyl)-Ph
96	4-F-Ph	4-(2-pyridyl)-Ph
97	4-F-Ph	4-(2-thienyl)-Ph
98	4-F-Ph	4-(2-furanyl)-Ph
99	4-F-Ph	2-CN-Ph
100	4-F-Ph	2-COCH3-Ph
101	4-F-Ph	2-CO2Me-Ph

102	4-F-Ph	2-CO ₂ Et-Ph
103	4-F-Ph	2-CO ₂ H-Ph
104	4-F-Ph	2-CONH ₂ -Ph
105	4-F-Ph	2-CONHMe-Ph
106	4-F-Ph	2-F-Ph
107	4-F-Ph	2-Cl-Ph
108	4-F-Ph	2-Br-Ph
109	4-F-Ph	2-NO ₂ -Ph
110	4-F-Ph	2-NH ₂ -Ph
111	4-F-Ph	2-NHMe-Ph
112	4-F-Ph	2-NMe ₂ -Ph
113	4-F-Ph	2-NHCOCH ₃ -Ph
114	4-F-Ph	2-SO ₂ NH ₂ -Ph
115	4-F-Ph	2-SO ₂ NHMe-Ph
116	4-F-Ph	2-CF ₃ -Ph
117	4-F-Ph	2-OCH ₃ -Ph
118	4-F-Ph	2-OPh-Ph
119	4-F-Ph	2-OCF ₃ -Ph
120	4-F-Ph	2-SCH ₃ -Ph
121	4-F-Ph	2-SOCH ₃ -Ph
122	4-F-Ph	2-SO ₂ CH ₃ -Ph
123	4-F-Ph	2-OH-Ph
124	4-F-Ph	2-CH ₂ OH-Ph
125	4-F-Ph	2-CHOHCH ₃ -Ph
126	4-F-Ph	2-COH(CH ₃) ₂ -Ph
127	4-F-Ph	2-CHOHPh-Ph
128	4-F-Ph	2-CH ₃ -Ph
129	4-F-Ph	2-C ₂ H ₅ -Ph
130	4-F-Ph	2-iPr-Ph
131	4-F-Ph	2-tBu-Ph
132	4-F-Ph	2-Ph-Ph
133	4-F-Ph	2-CH ₂ Ph-Ph
134	4-F-Ph	2-CH ₂ CO ₂ Me-Ph
135	4-F-Ph	2-(1-piperidinyl)-Ph
136	4-F-Ph	2-(1-pyrrolidinyl)-Ph
137	4-F-Ph	2-(2-imidazolyl)-Ph
138	4-F-Ph	2-(1-imidazolyl)-Ph
139	4-F-Ph	2-(2-thiazolyl)-Ph
140	4-F-Ph	2-(3-pyrazolyl)-Ph
141	4-F-Ph	2-(1-pyrazolyl)-Ph
142	4-F-Ph	2-(1-tetrazolyl)-Ph
143	4-F-Ph	2-(5-tetrazolyl)-Ph
144	4-F-Ph	2-(2-pyridyl)-Ph
145	4-F-Ph	2-(2-thienyl)-Ph
146	4-F-Ph	2-(2-furanyl)-Ph
147	4-F-Ph	2,4-diF-Ph
148	4-F-Ph	2,5-diF-Ph
149	4-F-Ph	2,6-diF-Ph
150	4-F-Ph	3,4-diF-Ph
151	4-F-Ph	3,5-diF-Ph
152	4-F-Ph	2,4-diCl-Ph
153	4-F-Ph	2,5-diCl-Ph
154	4-F-Ph	2,6-diCl-Ph

155	4-F-Ph	3,4-diCl-Ph
156	4-F-Ph	3,5-diCl-Ph
157	4-F-Ph	3,4-diCF ₃ -Ph
158	4-F-Ph	3,5-diCF ₃ -Ph
159	4-F-Ph	5-Cl-2-MeO-Ph
160	4-F-Ph	5-Cl-2-Me-Ph
161	4-F-Ph	2-F-5-Me-Ph
162	4-F-Ph	2-F-5-NO ₂ -Ph
163	4-F-Ph	3,4-OCH ₂ O-Ph
164	4-F-Ph	3,4-OCH ₂ CH ₂ O-Ph
165	4-F-Ph	2-MeO-4-Me-Ph
166	4-F-Ph	2-MeO-5-Me-Ph
167	4-F-Ph	1-naphthyl
168	4-F-Ph	2-naphthyl
169	4-F-Ph	2-thienyl
170	4-F-Ph	3-thienyl
171	4-F-Ph	2-furanyl
172	4-F-Ph	3-furanyl
173	4-F-Ph	2-pyridyl
174	4-F-Ph	3-pyridyl
175	4-F-Ph	4-pyridyl
176	4-F-Ph	2-indolyl
177	4-F-Ph	3-indolyl
178	4-F-Ph	5-indolyl
179	4-F-Ph	6-indolyl
180	4-F-Ph	3-indazolyl
181	4-F-Ph	5-indazolyl
182	4-F-Ph	6-indazolyl
183	4-F-Ph	2-imidazolyl
184	4-F-Ph	3-pyrazolyl
185	4-F-Ph	2-thiazolyl
186	4-F-Ph	5-tetrazolyl
187	4-F-Ph	2-benzimidazolyl
188	4-F-Ph	5-benzimidazolyl
189	4-F-Ph	2-benzothiazolyl
190	4-F-Ph	5-benzothiazolyl
191	4-F-Ph	2-benzoxazolyl
192	4-F-Ph	5-benzoxazolyl
193	4-F-Ph	1-adamantyl
194	4-F-Ph	2-adamantyl
195	4-F-Ph	t-Bu
196	2-F-Ph	3-CN-Ph
197	2-F-Ph	3-COCH ₃ -Ph
198	2-F-Ph	3-CO ₂ Me-Ph
199	2-F-Ph	3-CO ₂ Et-Ph
200	2-F-Ph	3-CO ₂ H-Ph
201	2-F-Ph	3-CONH ₂ -Ph
202	2-F-Ph	3-F-Ph
203	2-F-Ph	3-Cl-Ph
204	2-F-Ph	3-NH ₂ -Ph
205	2-F-Ph	3-SO ₂ NH ₂ -Ph
206	2-F-Ph	3-CF ₃ -Ph
207	2-F-Ph	3-OCH ₃ -Ph

208	2-F-Ph	3-OEt-Ph
209	2-F-Ph	3-OCF3-Ph
210	2-F-Ph	3-SO2CH3-Ph
211	2-F-Ph	3-OH-Ph
212	2-F-Ph	3-CH3-Ph
213	2-F-Ph	3-C2H5-Ph
214	2-F-Ph	4-CN-Ph
215	2-F-Ph	4-COCH3-Ph
216	2-F-Ph	4-CO2Me-Ph
217	2-F-Ph	4-CO2Et-Ph
218	2-F-Ph	4-CO2H-Ph
219	2-F-Ph	4-CONH2-Ph
220	2-F-Ph	4-F-Ph
221	2-F-Ph	4-Cl-Ph
222	2-F-Ph	4-NH2-Ph
223	2-F-Ph	4-SO2NH2-Ph
224	2-F-Ph	4-CF3-Ph
225	2-F-Ph	4-OCH3-Ph
226	2-F-Ph	4-OEt-Ph
227	2-F-Ph	4-OCF3-Ph
228	2-F-Ph	4-SO2CH3-Ph
229	2-F-Ph	4-OH-Ph
230	2-F-Ph	4-CH3-Ph
231	2-F-Ph	4-C2H5-Ph
232	2-F-Ph	2,4-diF-Ph
233	2-F-Ph	2,5-diF-Ph
234	2-F-Ph	3,4-diF-Ph
235	2-F-Ph	3,5-diF-Ph
236	2-F-Ph	2,4-diCl-Ph
237	2-F-Ph	2,5-diCl-Ph
238	2-F-Ph	3,4-diCl-Ph
239	2-F-Ph	3,5-diCl-Ph
240	2-F-Ph	3,4-OCH2O-Ph
241	2-F-Ph	3,4-OCH2CH2O-Ph
242	2-F-Ph	2-thienyl
243	2-F-Ph	2-furanyl
244	2-F-Ph	2-pyridyl
245	2-F-Ph	4-pyridyl
246	2-F-Ph	2-imidazolyl
247	2-F-Ph	3-pyrazolyl
248	2-F-Ph	2-thiazolyl
249	2-F-Ph	5-tetrazolyl
250	2-F-Ph	1-adamantyl
251	2,4-diF-Ph	3-CN-Ph
252	2,4-diF-Ph	3-COCH3-Ph
253	2,4-diF-Ph	3-CO2Me-Ph
254	2,4-diF-Ph	3-CO2Et-Ph
255	2,4-diF-Ph	3-CO2H-Ph
256	2,4-diF-Ph	3-CONH2-Ph
257	2,4-diF-Ph	3-F-Ph
258	2,4-diF-Ph	3-Cl-Ph
259	2,4-diF-Ph	3-NH2-Ph
260	2,4-diF-Ph	3-SO2NH2-Ph

261	2,4-diF-Ph	3-CF3-Ph
262	2,4-diF-Ph	3-OCH3-Ph
263	2,4-diF-Ph	3-OEt-Ph
264	2,4-diF-Ph	3-OCF3-Ph
265	2,4-diF-Ph	3-SO2CH3-Ph
266	2,4-diF-Ph	3-OH-Ph
267	2,4-diF-Ph	3-CH3-Ph
268	2,4-diF-Ph	3-C2H5-Ph
269	2,4-diF-Ph	4-CN-Ph
270	2,4-diF-Ph	4-COCH3-Ph
271	2,4-diF-Ph	4-CO2Me-Ph
272	2,4-diF-Ph	4-CO2Et-Ph
273	2,4-diF-Ph	4-CO2H-Ph
274	2,4-diF-Ph	4-CONH2-Ph
275	2,4-diF-Ph	4-F-Ph
276	2,4-diF-Ph	4-Cl-Ph
277	2,4-diF-Ph	4-NH2-Ph
278	2,4-diF-Ph	4-SO2NH2-Ph
279	2,4-diF-Ph	4-CF3-Ph
280	2,4-diF-Ph	4-OCH3-Ph
281	2,4-diF-Ph	4-OEt-Ph
282	2,4-diF-Ph	4-OCF3-Ph
283	2,4-diF-Ph	4-SO2CH3-Ph
284	2,4-diF-Ph	4-OH-Ph
285	2,4-diF-Ph	4-CH3-Ph
286	2,4-diF-Ph	4-C2H5-Ph
287	2,4-diF-Ph	2,4-diF-Ph
288	2,4-diF-Ph	2,5-diF-Ph
289	2,4-diF-Ph	3,4-diF-Ph
290	2,4-diF-Ph	3,5-diF-Ph
291	2,4-diF-Ph	2,4-diCl-Ph
292	2,4-diF-Ph	2,5-diCl-Ph
293	2,4-diF-Ph	3,4-diCl-Ph
294	2,4-diF-Ph	3,5-diCl-Ph
295	2,4-diF-Ph	3,4-OCH2O-Ph
296	2,4-diF-Ph	3,4-OCH2CH2O-Ph
297	2,4-diF-Ph	2-thienyl
298	2,4-diF-Ph	2-furanyl
299	2,4-diF-Ph	2-pyridyl
300	2,4-diF-Ph	4-pyridyl
301	2,4-diF-Ph	2-imidazolyl
302	2,4-diF-Ph	3-pyrazolyl
303	2,4-diF-Ph	2-thiazolyl
304	2,4-diF-Ph	5-tetrazolyl
305	2,4-diF-Ph	1-adamantyl
306	4-Cl-Ph	Ph
307	4-Cl-Ph	3-CN-Ph
308	4-Cl-Ph	3-COCH3-Ph
309	4-Cl-Ph	3-CO2Me-Ph
310	4-Cl-Ph	3-CO2Et-Ph
311	4-Cl-Ph	3-CO2H-Ph
312	4-Cl-Ph	3-CONH2-Ph
313	4-Cl-Ph	3-CONHMe-Ph

314	4-Cl-Ph	3-F-Ph
315	4-Cl-Ph	3-Cl-Ph
316	4-Cl-Ph	3-Br-Ph
317	4-Cl-Ph	3-NO ₂ -Ph
318	4-Cl-Ph	3-NH ₂ -Ph
319	4-Cl-Ph	3-NHMe-Ph
320	4-Cl-Ph	3-NMe ₂ -Ph
321	4-Cl-Ph	3-NHCOCH ₃ -Ph
322	4-Cl-Ph	3-SO ₂ NH ₂ -Ph
323	4-Cl-Ph	3-SO ₂ NHMe-Ph
324	4-Cl-Ph	3-CF ₃ -Ph
325	4-Cl-Ph	3-OCH ₃ -Ph
326	4-Cl-Ph	3-OPh-Ph
327	4-Cl-Ph	3-OCF ₃ -Ph
328	4-Cl-Ph	3-SCH ₃ -Ph
329	4-Cl-Ph	3-SOCH ₃ -Ph
330	4-Cl-Ph	3-SO ₂ CH ₃ -Ph
331	4-Cl-Ph	3-OH-Ph
332	4-Cl-Ph	3-CH ₂ OH-Ph
333	4-Cl-Ph	3-CHOHCH ₃ -Ph
334	4-Cl-Ph	3-COH(CH ₃) ₂ -Ph
335	4-Cl-Ph	3-CHOHPh-Ph
336	4-Cl-Ph	3-CH ₃ -Ph
337	4-Cl-Ph	3-C ₂ H ₅ -Ph
338	4-Cl-Ph	3-iPr-Ph
339	4-Cl-Ph	3-tBu-Ph
340	4-Cl-Ph	3-Ph-Ph
341	4-Cl-Ph	3-CH ₂ Ph-Ph
342	4-Cl-Ph	3-CH ₂ CO ₂ Me-Ph
343	4-Cl-Ph	3-(1-piperidinyl)-Ph
344	4-Cl-Ph	3-(1-pyrrolidinyl)-Ph
345	4-Cl-Ph	3-(2-imidazolyl)-Ph
346	4-Cl-Ph	3-(1-imidazolyl)-Ph
347	4-Cl-Ph	3-(2-thiazolyl)-Ph
348	4-Cl-Ph	3-(3-pyrazolyl)-Ph
349	4-Cl-Ph	3-(1-pyrazolyl)-Ph
350	4-Cl-Ph	3-(1-tetrazolyl)-Ph
351	4-Cl-Ph	3-(5-tetrazolyl)-Ph
352	4-Cl-Ph	3-(2-pyridyl)-Ph
353	4-Cl-Ph	3-(2-thienyl)-Ph
354	4-Cl-Ph	3-(2-furanyl)-Ph
355	4-Cl-Ph	4-CN-Ph
356	4-Cl-Ph	4-COCH ₃ -Ph
357	4-Cl-Ph	4-CO ₂ Me-Ph
358	4-Cl-Ph	4-CO ₂ Et-Ph
359	4-Cl-Ph	4-CO ₂ H-Ph
360	4-Cl-Ph	4-CONH ₂ -Ph
361	4-Cl-Ph	4-CONHMe-Ph
362	4-Cl-Ph	4-CONHPh-Ph
363	4-Cl-Ph	4-NHCONH ₂ -Ph
364	4-Cl-Ph	4-F-Ph
365	4-Cl-Ph	4-Cl-Ph
366	4-Cl-Ph	4-Br-Ph

367	4-Cl-Ph	4-NO2-Ph
368	4-Cl-Ph	4-NH2-Ph
369	4-Cl-Ph	4-NHMe-Ph
370	4-Cl-Ph	4-NMe2-Ph
371	4-Cl-Ph	4-NHCOCH3-Ph
372	4-Cl-Ph	4-SO2NH2-Ph
373	4-Cl-Ph	4-SO2NHMe-Ph
374	4-Cl-Ph	4-CF3-Ph
375	4-Cl-Ph	4-OCH3-Ph
376	4-Cl-Ph	4-OPh-Ph
377	4-Cl-Ph	4-OCF3-Ph
378	4-Cl-Ph	4-SCH3-Ph
379	4-Cl-Ph	4-SOCH3-Ph
380	4-Cl-Ph	4-SO2CH3-Ph
381	4-Cl-Ph	4-OH-Ph
382	4-Cl-Ph	4-CH2OH-Ph
383	4-Cl-Ph	4-CHOHCH3-Ph
384	4-Cl-Ph	4-COH(CH3)2-Ph
385	4-Cl-Ph	4-CH3-Ph
386	4-Cl-Ph	4-C2H5-Ph
387	4-Cl-Ph	4-iPr-Ph
388	4-Cl-Ph	4-tBu-Ph
389	4-Cl-Ph	4-Ph-Ph
390	4-Cl-Ph	4-CH2Ph-Ph
391	4-Cl-Ph	4-CH2CO2Me-Ph
392	4-Cl-Ph	4-(1-piperidinyl)-Ph
393	4-Cl-Ph	4-(1-pyrrolidinyl)-Ph
394	4-Cl-Ph	4-(2-imidazolyl)-Ph
395	4-Cl-Ph	4-(1-imidazolyl)-Ph
396	4-Cl-Ph	4-(2-thiazolyl)-Ph
397	4-Cl-Ph	4-(3-pyrazolyl)-Ph
398	4-Cl-Ph	4-(1-pyrazolyl)-Ph
399	4-Cl-Ph	4-(1-tetrazolyl)-Ph
400	4-Cl-Ph	4-(5-tetrazolyl)-Ph
401	4-Cl-Ph	4-(2-pyridyl)-Ph
402	4-Cl-Ph	4-(2-thienyl)-Ph
403	4-Cl-Ph	4-(2-furanyl)-Ph
404	4-Cl-Ph	2-CN-Ph
405	4-Cl-Ph	2-COCH3-Ph
406	4-Cl-Ph	2-CO2Me-Ph
407	4-Cl-Ph	2-CO2Et-Ph
408	4-Cl-Ph	2-CO2H-Ph
409	4-Cl-Ph	2-CONH2-Ph
410	4-Cl-Ph	2-CONHMe-Ph
411	4-Cl-Ph	2-F-Ph
412	4-Cl-Ph	2-Cl-Ph
413	4-Cl-Ph	2-Br-Ph
414	4-Cl-Ph	2-NO2-Ph
415	4-Cl-Ph	2-NH2-Ph
416	4-Cl-Ph	2-NHMe-Ph
417	4-Cl-Ph	2-NMe2-Ph
418	4-Cl-Ph	2-NHCOCH3-Ph
419	4-Cl-Ph	2-SO2NH2-Ph

420	4-Cl-Ph	2-SO ₂ NHMe-Ph
421	4-Cl-Ph	2-CF ₃ -Ph
422	4-Cl-Ph	2-OCH ₃ -Ph
423	4-Cl-Ph	2-OPh-Ph
424	4-Cl-Ph	2-OCF ₃ -Ph
425	4-Cl-Ph	2-SCH ₃ -Ph
426	4-Cl-Ph	2-SOCH ₃ -Ph
427	4-Cl-Ph	2-SO ₂ CH ₃ -Ph
428	4-Cl-Ph	2-OH-Ph
429	4-Cl-Ph	2-CH ₂ OH-Ph
430	4-Cl-Ph	2-CHOHCH ₃ -Ph
431	4-Cl-Ph	2-COH(CH ₃) ₂ -Ph
432	4-Cl-Ph	2-CHOHPh-Ph
433	4-Cl-Ph	2-CH ₃ -Ph
434	4-Cl-Ph	2-C ₂ H ₅ -Ph
435	4-Cl-Ph	2-iPr-Ph
436	4-Cl-Ph	2-tBu-Ph
437	4-Cl-Ph	2-Ph-Ph
438	4-Cl-Ph	2-CH ₂ Ph-Ph
439	4-Cl-Ph	2-CH ₂ CO ₂ Me-Ph
440	4-Cl-Ph	2-(1-piperidinyl)-Ph
441	4-Cl-Ph	2-(1-pyrrolidinyl)-Ph
442	4-Cl-Ph	2-(2-imidazolyl)-Ph
443	4-Cl-Ph	2-(1-imidazolyl)-Ph
444	4-Cl-Ph	2-(2-thiazolyl)-Ph
445	4-Cl-Ph	2-(3-pyrazolyl)-Ph
446	4-Cl-Ph	2-(1-pyrazolyl)-Ph
447	4-Cl-Ph	2-(1-tetrazolyl)-Ph
448	4-Cl-Ph	2-(5-tetrazolyl)-Ph
449	4-Cl-Ph	2-(2-pyridyl)-Ph
450	4-Cl-Ph	2-(2-thienyl)-Ph
451	4-Cl-Ph	2-(2-furanyl)-Ph
452	4-Cl-Ph	2,4-diF-Ph
453	4-Cl-Ph	2,5-diF-Ph
454	4-Cl-Ph	2,6-diF-Ph
455	4-Cl-Ph	3,4-diF-Ph
456	4-Cl-Ph	3,5-diF-Ph
457	4-Cl-Ph	2,4-diCl-Ph
458	4-Cl-Ph	2,5-diCl-Ph
459	4-Cl-Ph	2,6-diCl-Ph
460	4-Cl-Ph	3,4-diCl-Ph
461	4-Cl-Ph	3,5-diCl-Ph
462	4-Cl-Ph	3,4-diCF ₃ -Ph
463	4-Cl-Ph	3,5-diCF ₃ -Ph
464	4-Cl-Ph	5-Cl-2-MeO-Ph
465	4-Cl-Ph	5-Cl-2-Me-Ph
466	4-Cl-Ph	2-F-5-Me-Ph
467	4-Cl-Ph	2-F-5-NO ₂ -Ph
468	4-Cl-Ph	3,4-OCH ₂ O-Ph
469	4-Cl-Ph	3,4-OCH ₂ CH ₂ O-Ph
470	4-Cl-Ph	2-MeO-4-Me-Ph
471	4-Cl-Ph	2-MeO-5-Me-Ph
472	4-Cl-Ph	1-naphthyl

473	4-Cl-Ph	2-naphthyl
474	4-Cl-Ph	2-thienyl
475	4-Cl-Ph	3-thienyl
476	4-Cl-Ph	2-furanyl
477	4-Cl-Ph	3-furanyl
478	4-Cl-Ph	2-pyridyl
479	4-Cl-Ph	3-pyridyl
480	4-Cl-Ph	4-pyridyl
481	4-Cl-Ph	2-indolyl
482	4-Cl-Ph	3-indolyl
483	4-Cl-Ph	5-indolyl
484	4-Cl-Ph	6-indolyl
485	4-Cl-Ph	3-indazolyl
486	4-Cl-Ph	5-indazolyl
487	4-Cl-Ph	6-indazolyl
488	4-Cl-Ph	2-imidazolyl
489	4-Cl-Ph	3-pyrazolyl
490	4-Cl-Ph	2-thiazolyl
491	4-Cl-Ph	5-tetrazolyl
492	4-Cl-Ph	2-benzimidazolyl
493	4-Cl-Ph	5-benzimidazolyl
494	4-Cl-Ph	2-benzothiazolyl
495	4-Cl-Ph	5-benzothiazolyl
496	4-Cl-Ph	2-benzoxazolyl
497	4-Cl-Ph	5-benzoxazolyl
498	4-Cl-Ph	1-adamantyl
499	4-Cl-Ph	2-adamantyl
500	4-Cl-Ph	t-Bu
501	2-Cl-Ph	3-CN-Ph
502	2-Cl-Ph	3-COCH3-Ph
503	2-Cl-Ph	3-CO2Me-Ph
504	2-Cl-Ph	3-CO2Et-Ph
505	2-Cl-Ph	3-CO2H-Ph
506	2-Cl-Ph	3-CONH2-Ph
507	2-Cl-Ph	3-F-Ph
508	2-Cl-Ph	3-Cl-Ph
509	2-Cl-Ph	3-NH2-Ph
510	2-Cl-Ph	3-SO2NH2-Ph
511	2-Cl-Ph	3-CF3-Ph
512	2-Cl-Ph	3-OCH3-Ph
513	2-Cl-Ph	3-OEt-Ph
514	2-Cl-Ph	3-OCF3-Ph
515	2-Cl-Ph	3-SO2CH3-Ph
516	2-Cl-Ph	3-OH-Ph
517	2-Cl-Ph	3-CH3-Ph
518	2-Cl-Ph	3-C2H5-Ph
519	2-Cl-Ph	4-CN-Ph
520	2-Cl-Ph	4-COCH3-Ph
521	2-Cl-Ph	4-CO2Me-Ph
522	2-Cl-Ph	4-CO2Et-Ph
523	2-Cl-Ph	4-CO2H-Ph
524	2-Cl-Ph	4-CONH2-Ph
525	2-Cl-Ph	4-F-Ph

526	2-Cl-Ph	4-Cl-Ph
527	2-Cl-Ph	4-NH2-Ph
528	2-Cl-Ph	4-SO2NH2-Ph
529	2-Cl-Ph	4-CF3-Ph
530	2-Cl-Ph	4-OCH3-Ph
531	2-Cl-Ph	4-OEt-Ph
532	2-Cl-Ph	4-OCF3-Ph
533	2-Cl-Ph	4-SO2CH3-Ph
534	2-Cl-Ph	4-OH-Ph
535	2-Cl-Ph	4-CH3-Ph
536	2-Cl-Ph	4-C2H5-Ph
537	2-Cl-Ph	2,4-diF-Ph
538	2-Cl-Ph	2,5-diF-Ph
539	2-Cl-Ph	3,4-diF-Ph
540	2-Cl-Ph	3,5-diF-Ph
541	2-Cl-Ph	2,4-diCl-Ph
542	2-Cl-Ph	2,5-diCl-Ph
543	2-Cl-Ph	3,4-diCl-Ph
544	2-Cl-Ph	3,5-diCl-Ph
545	2-Cl-Ph	3,4-OCH2O-Ph
546	2-Cl-Ph	3,4-OCH2CH2O-Ph
547	2-Cl-Ph	2-thienyl
548	2-Cl-Ph	2-furanyl
549	2-Cl-Ph	2-pyridyl
550	2-Cl-Ph	4-pyridyl
551	2-Cl-Ph	2-imidazolyl
552	2-Cl-Ph	3-pyrazolyl
553	2-Cl-Ph	2-thiazolyl
554	2-Cl-Ph	5-tetrazolyl
555	2-Cl-Ph	1-adamantyl
556	2,4-diCl-Ph	3-CN-Ph
557	2,4-diCl-Ph	3-COCH3-Ph
558	2,4-diCl-Ph	3-CO2Me-Ph
559	2,4-diCl-Ph	3-CO2Et-Ph
560	2,4-diCl-Ph	3-CO2H-Ph
561	2,4-diCl-Ph	3-CONH2-Ph
562	2,4-diCl-Ph	3-F-Ph
563	2,4-diCl-Ph	3-Cl-Ph
564	2,4-diCl-Ph	3-NH2-Ph
565	2,4-diCl-Ph	3-SO2NH2-Ph
566	2,4-diCl-Ph	3-CF3-Ph
567	2,4-diCl-Ph	3-OCH3-Ph
568	2,4-diCl-Ph	3-OEt-Ph
569	2,4-diCl-Ph	3-OCF3-Ph
570	2,4-diCl-Ph	3-SO2CH3-Ph
571	2,4-diCl-Ph	3-OH-Ph
572	2,4-diCl-Ph	3-CH3-Ph
573	2,4-diCl-Ph	3-C2H5-Ph
574	2,4-diCl-Ph	4-CN-Ph
575	2,4-diCl-Ph	4-COCH3-Ph
576	2,4-diCl-Ph	4-CO2Me-Ph
577	2,4-diCl-Ph	4-CO2Et-Ph
578	2,4-diCl-Ph	4-CO2H-Ph

579	2,4-diCl-Ph	4-CONH2-Ph
580	2,4-diCl-Ph	4-F-Ph
581	2,4-diCl-Ph	4-Cl-Ph
582	2,4-diCl-Ph	4-NH2-Ph
583	2,4-diCl-Ph	4-SO2NH2-Ph
584	2,4-diCl-Ph	4-CF3-Ph
585	2,4-diCl-Ph	4-OCH3-Ph
586	2,4-diCl-Ph	4-OEt-Ph
587	2,4-diCl-Ph	4-OCF3-Ph
588	2,4-diCl-Ph	4-SO2CH3-Ph
589	2,4-diCl-Ph	4-OH-Ph
590	2,4-diCl-Ph	4-CH3-Ph
591	2,4-diCl-Ph	4-C2H5-Ph
592	2,4-diCl-Ph	2,4-diF-Ph
593	2,4-diCl-Ph	2,5-diF-Ph
594	2,4-diCl-Ph	3,4-diF-Ph
595	2,4-diCl-Ph	3,5-diF-Ph
596	2,4-diCl-Ph	2,4-diCl-Ph
597	2,4-diCl-Ph	2,5-diCl-Ph
598	2,4-diCl-Ph	3,4-diCl-Ph
599	2,4-diCl-Ph	3,5-diCl-Ph
600	2,4-diCl-Ph	3,4-OCH2O-Ph
601	2,4-diCl-Ph	3,4-OCH2CH2O-Ph
602	2,4-diCl-Ph	2-thienyl
603	2,4-diCl-Ph	2-furanyl
604	2,4-diCl-Ph	2-pyridyl
605	2,4-diCl-Ph	4-pyridyl
606	2,4-diCl-Ph	2-imidazolyl
607	2,4-diCl-Ph	3-pyrazolyl
608	2,4-diCl-Ph	2-thiazolyl
609	2,4-diCl-Ph	5-tetrazolyl
610	2,4-diCl-Ph	1-adamantyl
611	3-OCH3-Ph	3-CN-Ph
612	3-OCH3-Ph	3-COCH3-Ph
613	3-OCH3-Ph	3-CO2Me-Ph
614	3-OCH3-Ph	3-CO2Et-Ph
615	3-OCH3-Ph	3-CO2H-Ph
616	3-OCH3-Ph	3-CONH2-Ph
617	3-OCH3-Ph	3-F-Ph
618	3-OCH3-Ph	3-Cl-Ph
619	3-OCH3-Ph	3-NH2-Ph
620	3-OCH3-Ph	3-SO2NH2-Ph
621	3-OCH3-Ph	3-CF3-Ph
622	3-OCH3-Ph	3-OCH3-Ph
623	3-OCH3-Ph	3-OEt-Ph
624	3-OCH3-Ph	3-OCF3-Ph
625	3-OCH3-Ph	3-SO2CH3-Ph
626	3-OCH3-Ph	3-OH-Ph
627	3-OCH3-Ph	3-CH3-Ph
628	3-OCH3-Ph	3-C2H5-Ph
629	3-OCH3-Ph	4-CN-Ph
630	3-OCH3-Ph	4-COCH3-Ph
631	3-OCH3-Ph	4-CO2Me-Ph

632	3-OCH3-Ph	4-CO2Et-Ph
633	3-OCH3-Ph	4-CO2H-Ph
634	3-OCH3-Ph	4-CONH2-Ph
635	3-OCH3-Ph	4-F-Ph
636	3-OCH3-Ph	4-Cl-Ph
637	3-OCH3-Ph	4-NH2-Ph
638	3-OCH3-Ph	4-SO2NH2-Ph
639	3-OCH3-Ph	4-CF3-Ph
640	3-OCH3-Ph	4-OCH3-Ph
641	3-OCH3-Ph	4-OEt-Ph
642	3-OCH3-Ph	4-OCF3-Ph
643	3-OCH3-Ph	4-SO2CH3-Ph
644	3-OCH3-Ph	4-OH-Ph
645	3-OCH3-Ph	4-CH3-Ph
646	3-OCH3-Ph	4-C2H5-Ph
647	3-OCH3-Ph	2,4-diF-Ph
648	3-OCH3-Ph	2,5-diF-Ph
649	3-OCH3-Ph	3,4-diF-Ph
650	3-OCH3-Ph	3,5-diF-Ph
651	3-OCH3-Ph	2,4-diCl-Ph
652	3-OCH3-Ph	2,5-diCl-Ph
653	3-OCH3-Ph	3,4-diCl-Ph
654	3-OCH3-Ph	3,5-diCl-Ph
655	3-OCH3-Ph	3,4-OCH2O-Ph
656	3-OCH3-Ph	3,4-OCH2CH2O-Ph
657	3-OCH3-Ph	2-thienyl
658	3-OCH3-Ph	2-furanyl
659	3-OCH3-Ph	2-pyridyl
660	3-OCH3-Ph	4-pyridyl
661	3-OCH3-Ph	2-imidazolyl
662	3-OCH3-Ph	3-pyrazolyl
663	3-OCH3-Ph	2-thiazolyl
664	3-OCH3-Ph	5-tetrazolyl
665	3-OCH3-Ph	1-adamantyl
666	2-thienyl	3-CN-Ph
667	2-thienyl	3-COCH3-Ph
668	2-thienyl	3-F-Ph
669	2-thienyl	3-Cl-Ph
670	2-thienyl	3-NH2-Ph
671	2-thienyl	3-OCH3-Ph
672	2-thienyl	3-OH-Ph
673	2-thienyl	4-CN-Ph
674	2-thienyl	4-COCH3-Ph
675	2-thienyl	4-F-Ph
676	2-thienyl	4-Cl-Ph
677	2-thienyl	4-NH2-Ph
678	2-thienyl	4-OCH3-Ph
679	2-thienyl	4-OH-Ph
680	2-thienyl	3,4-diF-Ph
681	2-thienyl	3,5-diF-Ph
682	2-thienyl	3,4-diCl-Ph
683	2-thienyl	3,5-diCl-Ph
684	2-thienyl	3,4-OCH2O-Ph

685	2-thienyl	3,4-OCH ₂ CH ₂ O-Ph
686	3-thienyl	3-CN-Ph
687	3-thienyl	3-COCH ₃ -Ph
688	3-thienyl	3-F-Ph
689	3-thienyl	3-Cl-Ph
690	3-thienyl	3-NH ₂ -Ph
691	3-thienyl	3-OCH ₃ -Ph
692	3-thienyl	3-OH-Ph
693	3-thienyl	4-CN-Ph
694	3-thienyl	4-COCH ₃ -Ph
695	3-thienyl	4-F-Ph
696	3-thienyl	4-Cl-Ph
697	3-thienyl	4-NH ₂ -Ph
698	3-thienyl	4-OCH ₃ -Ph
699	3-thienyl	4-OH-Ph
700	3-thienyl	3,4-diF-Ph
701	3-thienyl	3,5-diF-Ph
702	3-thienyl	3,4-diCl-Ph
703	3-thienyl	3,5-diCl-Ph
704	3-thienyl	3,4-OCH ₂ O-Ph
705	3-thienyl	3,4-OCH ₂ CH ₂ O-Ph
706	2-furanyl	3-CN-Ph
707	2-furanyl	3-COCH ₃ -Ph
708	2-furanyl	3-F-Ph
709	2-furanyl	3-Cl-Ph
710	2-furanyl	3-NH ₂ -Ph
711	2-furanyl	3-OCH ₃ -Ph
712	2-furanyl	3-OH-Ph
713	2-furanyl	4-CN-Ph
714	2-furanyl	4-COCH ₃ -Ph
715	2-furanyl	4-F-Ph
716	2-furanyl	4-Cl-Ph
717	2-furanyl	4-NH ₂ -Ph
718	2-furanyl	4-OCH ₃ -Ph
719	2-furanyl	4-OH-Ph
720	2-furanyl	3,4-diF-Ph
721	2-furanyl	3,5-diF-Ph
722	2-furanyl	3,4-diCl-Ph
723	2-furanyl	3,5-diCl-Ph
724	2-furanyl	3,4-OCH ₂ O-Ph
725	2-furanyl	3,4-OCH ₂ CH ₂ O-Ph
726	3-furanyl	3-CN-Ph
727	3-furanyl	3-COCH ₃ -Ph
728	3-furanyl	3-F-Ph
729	3-furanyl	3-Cl-Ph
730	3-furanyl	3-NH ₂ -Ph
731	3-furanyl	3-OCH ₃ -Ph
732	3-furanyl	3-OH-Ph
733	3-furanyl	4-CN-Ph
734	3-furanyl	4-COCH ₃ -Ph
735	3-furanyl	4-F-Ph
736	3-furanyl	4-Cl-Ph
737	3-furanyl	4-NH ₂ -Ph

738	3-furanyl	4-OCH ₃ -Ph
739	3-furanyl	4-OH-Ph
740	3-furanyl	3,4-diF-Ph
741	3-furanyl	3,5-diF-Ph
742	3-furanyl	3,4-diCl-Ph
743	3-furanyl	3,5-diCl-Ph
744	3-furanyl	3,4-OCH ₂ O-Ph
745	3-furanyl	3,4-OCH ₂ CH ₂ O-Ph
746	2-pyridyl	3-CN-Ph
747	2-pyridyl	3-COCH ₃ -Ph
748	2-pyridyl	3-F-Ph
749	2-pyridyl	3-Cl-Ph
750	2-pyridyl	3-NH ₂ -Ph
751	2-pyridyl	3-OCH ₃ -Ph
752	2-pyridyl	3-OH-Ph
753	2-pyridyl	4-CN-Ph
754	2-pyridyl	4-COCH ₃ -Ph
755	2-pyridyl	4-F-Ph
756	2-pyridyl	4-Cl-Ph
757	2-pyridyl	4-NH ₂ -Ph
758	2-pyridyl	4-OCH ₃ -Ph
759	2-pyridyl	4-OH-Ph
760	2-pyridyl	3,4-diF-Ph
761	2-pyridyl	3,5-diF-Ph
762	2-pyridyl	3,4-diCl-Ph
763	2-pyridyl	3,5-diCl-Ph
764	2-pyridyl	3,4-OCH ₂ O-Ph
765	2-pyridyl	3,4-OCH ₂ CH ₂ O-Ph
766	3-pyridyl	3-CN-Ph
767	3-pyridyl	3-COCH ₃ -Ph
768	3-pyridyl	3-F-Ph
769	3-pyridyl	3-Cl-Ph
770	3-pyridyl	3-NH ₂ -Ph
771	3-pyridyl	3-OCH ₃ -Ph
772	3-pyridyl	3-OH-Ph
773	3-pyridyl	4-CN-Ph
774	3-pyridyl	4-COCH ₃ -Ph
775	3-pyridyl	4-F-Ph
776	3-pyridyl	4-Cl-Ph
777	3-pyridyl	4-NH ₂ -Ph
778	3-pyridyl	4-OCH ₃ -Ph
779	3-pyridyl	4-OH-Ph
780	3-pyridyl	3,4-diF-Ph
781	3-pyridyl	3,5-diF-Ph
782	3-pyridyl	3,4-diCl-Ph
783	3-pyridyl	3,5-diCl-Ph
784	3-pyridyl	3,4-OCH ₂ O-Ph
785	3-pyridyl	3,4-OCH ₂ CH ₂ O-Ph
786	4-pyridyl	3-CN-Ph
787	4-pyridyl	3-COCH ₃ -Ph
788	4-pyridyl	3-F-Ph
789	4-pyridyl	3-Cl-Ph
790	4-pyridyl	3-NH ₂ -Ph

791	4-pyridyl	3-OCH3-Ph
792	4-pyridyl	3-OH-Ph
793	4-pyridyl	4-CN-Ph
794	4-pyridyl	4-COCH3-Ph
795	4-pyridyl	4-F-Ph
796	4-pyridyl	4-Cl-Ph
797	4-pyridyl	4-NH2-Ph
798	4-pyridyl	4-OCH3-Ph
799	4-pyridyl	4-OH-Ph
800	4-pyridyl	3,4-diF-Ph
801	4-pyridyl	3,5-diF-Ph
802	4-pyridyl	3,4-diCl-Ph
803	4-pyridyl	3,5-diCl-Ph
804	4-pyridyl	3,4-OCH2O-Ph
805	4-pyridyl	3,4-OCH2CH2O-Ph
806	3-indolyl	3-CN-Ph
807	3-indolyl	3-COCH3-Ph
808	3-indolyl	3-F-Ph
809	3-indolyl	3-Cl-Ph
810	3-indolyl	3-NH2-Ph
811	3-indolyl	3-OCH3-Ph
812	3-indolyl	3-OH-Ph
813	3-indolyl	4-CN-Ph
814	3-indolyl	4-COCH3-Ph
815	3-indolyl	4-F-Ph
816	3-indolyl	4-Cl-Ph
817	3-indolyl	4-NH2-Ph
818	3-indolyl	4-OCH3-Ph
819	3-indolyl	4-OH-Ph
820	3-indolyl	3,4-diF-Ph
821	3-indolyl	3,5-diF-Ph
822	3-indolyl	3,4-diCl-Ph
823	3-indolyl	3,5-diCl-Ph
824	3-indolyl	3,4-OCH2O-Ph
825	3-indolyl	3,4-OCH2CH2O-Ph
826	5-indolyl	3-CN-Ph
827	5-indolyl	3-COCH3-Ph
828	5-indolyl	3-F-Ph
829	5-indolyl	3-Cl-Ph
830	5-indolyl	3-NH2-Ph
831	5-indolyl	3-OCH3-Ph
832	5-indolyl	3-OH-Ph
833	5-indolyl	4-CN-Ph
834	5-indolyl	4-COCH3-Ph
835	5-indolyl	4-F-Ph
836	5-indolyl	4-Cl-Ph
837	5-indolyl	4-NH2-Ph
838	5-indolyl	4-OCH3-Ph
839	5-indolyl	4-OH-Ph
840	5-indolyl	3,4-diF-Ph
841	5-indolyl	3,5-diF-Ph
842	5-indolyl	3,4-diCl-Ph
843	5-indolyl	3,5-diCl-Ph

844	5-indolyl	3,4-OCH ₂ O-Ph
845	5-indolyl	3,4-OCH ₂ CH ₂ O-Ph
846	5-indazolyl	3-CN-Ph
847	5-indazolyl	3-COCH ₃ -Ph
848	5-indazolyl	3-F-Ph
849	5-indazolyl	3-Cl-Ph
850	5-indazolyl	3-NH ₂ -Ph
851	5-indazolyl	3-OCH ₃ -Ph
852	5-indazolyl	3-OH-Ph
853	5-indazolyl	4-CN-Ph
854	5-indazolyl	4-COCH ₃ -Ph
855	5-indazolyl	4-F-Ph
856	5-indazolyl	4-Cl-Ph
857	5-indazolyl	4-NH ₂ -Ph
858	5-indazolyl	4-OCH ₃ -Ph
859	5-indazolyl	4-OH-Ph
860	5-indazolyl	3,4-diF-Ph
861	5-indazolyl	3,5-diF-Ph
862	5-indazolyl	3,4-diCl-Ph
863	5-indazolyl	3,5-diCl-Ph
864	5-indazolyl	3,4-OCH ₂ O-Ph
865	5-indazolyl	3,4-OCH ₂ CH ₂ O-Ph
866	5-benzimidazolyl	3-CN-Ph
867	5-benzimidazolyl	3-COCH ₃ -Ph
868	5-benzimidazolyl	3-F-Ph
869	5-benzimidazolyl	3-Cl-Ph
870	5-benzimidazolyl	3-NH ₂ -Ph
871	5-benzimidazolyl	3-OCH ₃ -Ph
872	5-benzimidazolyl	3-OH-Ph
873	5-benzimidazolyl	4-CN-Ph
874	5-benzimidazolyl	4-COCH ₃ -Ph
875	5-benzimidazolyl	4-F-Ph
876	5-benzimidazolyl	4-Cl-Ph
877	5-benzimidazolyl	4-NH ₂ -Ph
878	5-benzimidazolyl	4-OCH ₃ -Ph
879	5-benzimidazolyl	4-OH-Ph
880	5-benzimidazolyl	3,4-diF-Ph
881	5-benzimidazolyl	3,5-diF-Ph

882	5- benzimidazolyl	3,4-diCl-Ph
883	5- benzimidazolyl	3,5-diCl-Ph
884	5- benzimidazolyl	3,4-OCH ₂ O-Ph
885	5- benzimidazolyl	3,4-OCH ₂ CH ₂ O-Ph
886	5- benzothiazolyl	3-CN-Ph
887	5- benzothiazolyl	3-COCH ₃ -Ph
888	5- benzothiazolyl	3-F-Ph
889	5- benzothiazolyl	3-Cl-Ph
890	5- benzothiazolyl	3-NH ₂ -Ph
891	5- benzothiazolyl	3-OCH ₃ -Ph
892	5- benzothiazolyl	3-OH-Ph
893	5- benzothiazolyl	4-CN-Ph
894	5- benzothiazolyl	4-COCH ₃ -Ph
895	5- benzothiazolyl	4-F-Ph
896	5- benzothiazolyl	4-Cl-Ph
897	5- benzothiazolyl	4-NH ₂ -Ph
898	5- benzothiazolyl	4-OCH ₃ -Ph
899	5- benzothiazolyl	4-OH-Ph
900	5- benzothiazolyl	3,4-diF-Ph
901	5- benzothiazolyl	3,5-diF-Ph
902	5- benzothiazolyl	3,4-diCl-Ph
903	5- benzothiazolyl	3,5-diCl-Ph
904	5- benzothiazolyl	3,4-OCH ₂ O-Ph
905	5- benzothiazolyl	3,4-OCH ₂ CH ₂ O-Ph
906	5-benzoxazolyl	3-CN-Ph
907	5-benzoxazolyl	3-COCH ₃ -Ph
908	5-benzoxazolyl	3-F-Ph
909	5-benzoxazolyl	3-Cl-Ph
910	5-benzoxazolyl	3-NH ₂ -Ph
911	5-benzoxazolyl	3-OCH ₃ -Ph

912	5-benzoxazolyl	3-OH-Ph
913	5-benzoxazolyl	4-CN-Ph
914	5-benzoxazolyl	4-COCH3-Ph
915	5-benzoxazolyl	4-F-Ph
916	5-benzoxazolyl	4-Cl-Ph
917	5-benzoxazolyl	4-NH2-Ph
918	5-benzoxazolyl	4-OCH3-Ph
919	5-benzoxazolyl	4-OH-Ph
920	5-benzoxazolyl	3,4-diF-Ph
921	5-benzoxazolyl	3,5-diF-Ph
922	5-benzoxazolyl	3,4-diCl-Ph
923	5-benzoxazolyl	3,5-diCl-Ph
924	5-benzoxazolyl	3,4-OCH2O-Ph
925	5-benzoxazolyl	3,4-OCH2CH2O-Ph

Utility

The utility of the compounds in accordance with the present invention as modulators of chemokine receptor activity may be demonstrated by methodology known in the art, such as the assays for CCR-2 and CCR-3 ligand binding, as disclosed by Ponath et al., J. Exp. Med., 183, 2437-2448 (1996) and Uguccioni et al., J. Clin. Invest., 100, 1137-1143 (1997). Cell lines for expressing the receptor of interest include those naturally expressing the chemokine receptor, such as EOL-3 or THP-1, those induced to express the chemokine receptor by the addition of chemical or protein agents, such as HL-60 or AML14.3D10 cells treated with, for example, butyric acid with interleukin-5 present, or a cell engineered to express a recombinant chemokine receptor, such as CHO or HEK-293. Finally, blood or tissue cells, for example human peripheral blood eosinophils, isolated using methods as described by Hansel et al., J. Immunol. Methods, 145, 105-110 (1991), can be utilized in such assays. In particular, the compound of the present invention have activity in binding to the CCR-3 receptor in the aforementioned assays. As used herein, "activity" is intended to mean a compound demonstrating an IC50 of 10 μ M or lower in concentration when measured in the aforementioned assays. Such a result is indicative of the intrinsic

activity of the compounds as modulators of chemokine receptor activity. A general binding protocol is described below.

5 CCR3-Receptor Binding Protocol

Millipore filter plates (#MABVN1250) are treated with 5 µg/ml protamine in phosphate buffered saline, pH 7.2, for ten minutes at room temperature. Plates are washed three
10 times with phosphate buffered saline and incubated with phosphate buffered saline for thirty minutes at room temperature. For binding, 50 µl of binding buffer (0.5% bovine serum albumen, 20 mM HEPES buffer and 5 mM magnesium chloride in RPMI 1640 media) with or without a test
15 concentration of a compound present at a known concentration is combined with 50 µl of 125-I labeled human eotaxin (to give a final concentration of 150 pM radioligand) and 50 µl of cell suspension in binding buffer containing 5x10⁵ total cells. Cells used for such binding
20 assays can include cell lines transfected with a gene expressing CCR3 such as that described by Daugherty et al. (1996), isolated human eosinophils such as described by Hansel et al. (1991) or the AML14.3D10 cell line after differentiation with butyric acid as described by Tiffany
25 et al. (1998). The mixture of compound, cells and radioligand are incubated at room temperature for thirty minutes. Plates are placed onto a vacuum manifold, vacuum applied, and plates washed three times with binding buffer with 0.5M NaCl added. The plastic skirt is removed from
30 the plate, the plate allowed to air dry, the wells punch out and CPM counted. The percent inhibition of binding is calculated using the total count obtained in the absence of any competing compound or chemokine ligand and the background binding determined by addition of 100 nM eotaxin
35 in place of the test compound.

The utility of the compounds in accordance with the present invention as inhibitors of the migration of eosinophils or cell lines expressing the chemokine receptors may be demonstrated by methodology known in the art, such as the chemotaxis assay disclosed by Bacon et al., Brit. J. Pharmacol., 95, 966-974 (1988). In particular, the compound of the present invention have activity in inhibition of the migration of eosinophils in the aforementioned assays. As used herein, "activity" is intended to mean a compound demonstrating an IC50 of 10 μ M or lower in concentration when measured in the aforementioned assays. Such a result is indicative of the intrinsic activity of the compounds as modulators of chemokine receptor activity. A human eosinophil chemotaxis assay protocol is described below.

Human Eosinophil Chemotaxis Assay

Neuroprobe MBA96 96-well chemotaxis chambers with Neuroprobe polyvinylpyrrolidone-free polycarbonate PFD5 5-micron filters in place are warmed in a 37°C incubator prior to assay. Freshly isolated human eosinophils, isolated according to a method such as that described by Hansel et al. (1991), are suspended in RPMI 1640 with 0.1% bovine serum albumin at 1 x 10⁶ cells/ml and warmed in a 37°C incubator prior to assay. A 20 nM solution of human eotaxin in RPMI 1640 with 0.1% bovine serum albumin is warmed in a 37°C incubator prior to assay. The eosinophil suspension and the 20 nM eotaxin solution are each mixed 1:1 with prewarmed RPMI 1640 with 0.1% bovine serum albumin with or without a dilution of a test compound that is at two fold the desired final concentration. These mixtures are warmed in a 37°C incubator prior to assay. The filter is separated from the prewarmed Neuroprobe chemotaxis chamber and the eotaxin/compound mixture is placed into a Polyfiltronics MPC 96 well plate that has been placed in the bottom part of the Neuro Probe chemotaxis chamber. The

approximate volume is 370 microliters and there should be a positive meniscus after dispensing. The filter is replaced above the 96 well plate, the rubber gasket is attached to the bottom of the upper chamber, and the chamber assembled.

5 A 200 μ l volume of the cell suspension/compound mixture is added to the appropriate wells of the upper chamber. The upper chamber is covered with a plate sealer, and the assembled unit placed in a 37°C incubator for 45 minutes. After incubation, the plate sealer is removed and all

10 remaining cell suspension is aspirated off. The chamber is disassembled and, while holding the filter by the sides at a 90-degree angle, unmigrated cells are washed away using a gentle stream of phosphate buffered saline dispensed from a squirt bottle and then the filter wiped with a rubber

15 tipped squeegee. The filter is allowed to completely dry and immersed completely in Wright Giemsa stain for 30-45 seconds. The filter is rinsed with distilled water for 7 minutes, rinsed once with water briefly, and allowed to dry. Migrated cells are enumerated by microscopy.

20

Mammalian chemokine receptors provide a target for interfering with or promoting immune cell function in a mammal, such as a human. Compounds that inhibit or promote chemokine receptor function are

25 particularly useful for modulating immune cell function for therapeutic purposes. Accordingly, the present invention is directed to compounds which are useful in the prevention and/or treatment of a wide variety of inflammatory, infectious, and

30 immunoregulatory disorders and diseases, including asthma and allergic diseases, infection by pathogenic microbes (which, by definition, includes viruses), as well as autoimmune pathologies such as the rheumatoid arthritis and atherosclerosis.

35

For example, an instant compound which inhibits one or more functions of a mammalian chemokine receptor (e.g., a human chemokine receptor) may be

administered to inhibit (i.e., reduce or prevent) inflammation or infectious disease. As a result, one or more inflammatory process, such as leukocyte emigration, adhesion, chemotaxis, exocytosis (e.g., of enzymes, histamine) or inflammatory mediator release, is inhibited. For example, eosinophilic infiltration to inflammatory sites (e.g., in asthma or allergic rhinitis) can be inhibited according to the present method. In particular, the compound of the following examples has activity in blocking the migration of cells expressing the CCR-3 receptor using the appropriate chemokines in the aforementioned assays. As used herein, "activity" is intended to mean a compound demonstrating an IC₅₀ of 10 μ M or lower in concentration when measured in the aforementioned assays. Such a result is also indicative of the intrinsic activity of the compounds as modulators of chemokine receptor activity.

Similarly, an instant compound which promotes one or more functions of the mammalian chemokine receptor (e.g., a human chemokine) as administered to stimulate (induce or enhance) an immune or inflammatory response, such as leukocyte emigration, adhesion, chemotaxis, exocytosis (e.g., of enzymes, histamine) or inflammatory mediator release, resulting in the beneficial stimulation of inflammatory processes. For example, eosinophils can be recruited to combat parasitic infections. In addition, treatment of the aforementioned inflammatory, allergic and autoimmune diseases can also be contemplated for an instant compound which promotes one or more functions of the mammalian chemokine receptor if one contemplates the delivery of sufficient compound to cause the loss of receptor expression on cells through the induction of chemokine receptor internalization or the delivery of compound in a manner that results in the misdirection of the migration of cells.

In addition to primates, such as humans, a variety of other mammals can be treated according to the method of the present invention. For instance, mammals, including but not limited to, cows, sheep, goats, horses, dogs, cats, guinea pigs, rats or other bovine, ovine, equine, canine, feline, rodent or murine species can be treated. However, the method can also be practiced in other species, such as avian species. The subject treated in the methods above is a mammal, male or female, in whom modulation of chemokine receptor activity is desired. "Modulation" as used herein is intended to encompass antagonism, agonism, partial antagonism and/or partial agonism.

Diseases or conditions of human or other species which can be treated with inhibitors of chemokine receptor function, include, but are not limited to: inflammatory or allergic diseases and conditions, including respiratory allergic diseases such as asthma, allergic rhinitis, hypersensitivity lung diseases, hypersensitivity pneumonitis, eosinophilic cellulitis (e.g., Wells' syndrome), eosinophilic pneumonias (e.g., Loeffler's syndrome, chronic eosinophilic pneumonia), eosinophilic fasciitis (e.g., Shulman's syndrome), delayed-type hypersensitivity, interstitial lung diseases (ILD) (e.g., idiopathic pulmonary fibrosis, or ILD associated with rheumatoid arthritis, systemic lupus erythematosus, ankylosing spondylitis, systemic sclerosis, Sjogren's syndrome, polymyositis or dermatomyositis); systemic anaphylaxis or hypersensitivity responses, drug allergies (e.g., to penicillin, cephalosporins), eosinophilia-myalgia syndrome due to the ingestion of contaminated tryptophan, insect sting allergies; autoimmune diseases, such as rheumatoid arthritis, psoriatic arthritis, multiple sclerosis, systemic lupus erythematosus, myasthenia gravis, juvenile onset diabetes; glomerulonephritis, autoimmune thyroiditis, Behcet's disease; graft rejection (e.g., in transplantation), including allograft rejection or graft-versus-host disease; inflammatory bowel diseases, such as

Crohn's disease and ulcerative colitis;
spondyloarthropathies; scleroderma; psoriasis (including T-
cell mediated psoriasis) and inflammatory dermatoses such
as an dermatitis, eczema, atopic dermatitis, allergic
5 contact dermatitis, urticaria; vasculitis (e.g.,
necrotizing, cutaneous, and hypersensitivity vasculitis);
eosinophilic myositis, eosinophilic fasciitis; cancers with
leukocyte infiltration of the skin or organs. Other
diseases or conditions in which undesirable inflammatory
10 responses are to be inhibited can be treated, including,
but not limited to, reperfusion injury, atherosclerosis,
certain hematologic malignancies, cytokine-induced toxicity
(e.g., septic shock, endotoxic shock), polymyositis,
dermatomyositis. Infectious diseases or conditions of
15 human or other species which can be treated with inhibitors
of chemokine receptor function, include, but are not
limited to, HIV.

Diseases or conditions of humans or other species
which can be treated with promoters of chemokine receptor
20 function, include, but are not limited to:
immunosuppression, such as that in individuals with
immunodeficiency syndromes such as AIDS or other viral
infections, individuals undergoing radiation therapy,
chemotherapy, therapy for autoimmune disease or drug
25 therapy (e.g., corticosteroid therapy), which causes
immunosuppression; immunosuppression due to congenital
deficiency in receptor function or other causes; and
infections diseases, such as parasitic diseases, including,
but not limited to helminth infections, such as nematodes
30 (round worms); (Trichuriasis, Enterobiasis, Ascariasis,
Hookworm, Strongyloidiasis, Trichinosis, filariasis);
trematodes (flukes) (Schistosomiasis, Clonorchiasis),
cestodes (tape worms) (Echinococcosis, Taeniasis saginata,
Cysticercosis); visceral worms, visceral larva migraines
35 (e.g., Toxocara), eosinophilic gastroenteritis (e.g.,
Anisaki sp., Phocanema sp.), cutaneous larva migraines
(Ancylostona braziliense, Ancylostoma caninum). The

compounds of the present invention are accordingly useful in the prevention and treatment of a wide variety of inflammatory, infectious and immunoregulatory disorders and diseases. In addition, treatment of the aforementioned
5 inflammatory, allergic and autoimmune diseases can also be contemplated for promoters of chemokine receptor function if one contemplates the delivery of sufficient compound to cause the loss of receptor expression on cells through the induction of chemokine receptor internalization or delivery
10 of compound in a manner that results in the misdirection of the migration of cells.

In another aspect, the instant invention may be used to evaluate the putative specific agonists or antagonists of a G protein coupled receptor. The
15 present invention is directed to the use of these compounds in the preparation and execution of screening assays for compounds that modulate the activity of chemokine receptors. Furthermore, the compounds of this invention are useful in establishing
20 or determining the binding site of other compounds to chemokine receptors, e.g., by competitive inhibition or as a reference in an assay to compare its known activity to a compound with an unknown activity. When developing new assays or protocols, compounds
25 according to the present invention could be used to test their effectiveness. Specifically, such compounds may be provided in a commercial kit, for example, for use in pharmaceutical research involving the aforementioned diseases. The compounds of the
30 instant invention are also useful for the evaluation of putative specific modulators of the chemokine receptors. In addition, one could utilize compounds of this invention to examine the specificity of G protein coupled receptors that are not thought to be
35 chemokine receptors, either by serving as examples of compounds which do not bind or as structural variants

of compounds active on these receptors which may help define specific sites of interaction.

Combined therapy to prevent and treat inflammatory, infectious and immunoregulatory disorders and diseases, including asthma and allergic diseases, as well as autoimmune pathologies such as rheumatoid arthritis and atherosclerosis, and those pathologies noted above is illustrated by the combination of the compounds of this invention and other compounds which are known for such utilities. For example, in the treatment or prevention of inflammation, the present compounds may be used in conjunction with an anti-inflammatory or analgesic agent such as an opiate agonist, a lipoxygenase inhibitor, a cyclooxygenase-2 inhibitor, an interleukin inhibitor, such as an interleukin-1 inhibitor, a tumor necrosis factor inhibitor, an NMDA antagonist, an inhibitor of nitric oxide or an inhibitor of the synthesis of nitric oxide, a non-steroidal anti-inflammatory agent, a phosphodiesterase inhibitor, or a cytokine-suppressing anti-inflammatory agent, for example with a compound such as acetaminophen, aspirin, codeine, fentanyl, ibuprofen, indomethacin, ketorolac, morphine, naproxen, phenacetin, piroxicam, a steroidal analgesic, sufentanyl, sunlindac, interferon alpha and the like. Similarly, the instant compounds may be administered with a pain reliever; a potentiator such as caffeine, an H2-antagonist, simethicone, aluminum or magnesium hydroxide; a decongestant such as phenylephrine, phenylpropanolamine, pseudophedrine, oxymetazoline, ephinephrine, naphazoline, xylometazoline, propylhexedrine, or levodesoxy-ephedrine; and antitussive such as codeine, hydrocodone, caramiphen, carbetapentane, or dextramethorphan; a diuretic; and a sedating or non-sedating antihistamine. Likewise, compounds of the present invention may be used in combination with other drugs that are used in the treatment/prevention/suppression or amelioration of the diseases or conditions for which compound of the present invention are useful. Such other

drugs may be administered, by a route and in an amount commonly used therefore, contemporaneously or sequentially with a compound of the present invention. When a compound of the present invention is used contemporaneously with one or more other drugs, a pharmaceutical composition containing such other drugs in addition to the compound of the present invention is preferred. Accordingly, the pharmaceutical compositions of the present invention include those that also contain one or more other active ingredients, in addition to a compound of the present invention. Examples of other active ingredients that may be combined with a compound of the present invention, either administered separately or in the same pharmaceutical compositions, include, but are not limited to: (a) integrin antagonists such as those for selectins, ICAMs and VLA-4; (b) steroids such as beclomethasone, methylprednisolone, betamethasone, prednisone, dexamethasone, and hydrocortisone; (c) immunosuppressants such as cyclosporin, tacrolimus, rapamycin and other FK-506 type immunosuppressants; (d) antihistamines (H1-histamine antagonists) such as bromopheniramine, chlorpheniramine, dexchlorpheniramine, triprolidine, clemastine, diphenhydramine, diphenylpyraline, tripelennamine, hydroxyzine, methdilazine, promethazine, trimeprazine, azatadine, cyproheptadine, antazoline, pheniramine, pyrillamine, astemizole, terfenadine, loratadine, cetirizine, fexofenadine, descarboethoxyloratadine, and the like; (e) non-steroidal anti-asthmatics such as b2-agonists (terbutaline, metaproterenol, fenoterol, isoetharine, albuteral, bitolterol, and pirbuterol), theophylline, cromolyn sodium, atropine, ipratropium bromide, leukotriene antagonists (zafirlukast, montelukast, pranlukast, iralukast, pobilukast, SKB-102,203), leukotriene biosynthesis inhibitors (zileuton, BAY-1005); (f) non-steroidal antiinflammatory agents (NSAIDs) such as propionic acid derivatives (alminoprofen, benxaprofen, bucloxic acid, carprofen, fenbufen, fenoprofen, fluprofen,

flurbiprofen, ibuprofen, indoprofen, ketoprofen, miroprofen, naproxen, oxaprozin, piroprofen, pranoprofen, suprofen, tiaprofenic acid, and tioxaprofen), acetic acid derivatives (indomethacin, acemetacin, alclofenac, clidanac, diclofenac, fenclofenac, fenclozic acid, fentiazac, furofenac, ibufenac, isoxepac, oxpinac, sulindac, tiopinac, tolmetin, zidometacin, and zomepirac), fenamic acid derivatives (flufenamic acid, meclofenamic acid, mefenamic acid, niflumic acid and tolfenamic acid), biphenylcarboxylic acid derivatives (diflunisal and flufenisal), oxicams (isoxicam, piroxicam, sudoxicam and tenoxicam), salicylates (acetyl salicylic acid, sulfasalazine) and the pyrazolones (apazone, bezpiperylon, feprazone, mofebutazone, oxyphenbutazone, phenylbutazone); (g) cyclooxygenase-2 (COX-2) inhibitors; (h) inhibitors of phosphodiesterase type IV (PDE-IV); (i) other antagonists of the chemokine receptors; (j) cholesterol lowering agents such as HMG-COA reductase inhibitors (lovastatin, simvastatin and pravastatin, fluvastatin, atorvastatin, and other statins), sequestrants (cholestyramine and colestipol), nicotonic acid, fenofibric acid derivatives (gemfibrozil, clofibrat, fenofibrate and benza-fibrate), and probucol; (k) anti-diabetic agents such as insulin, sulfonylureas, biguanides (metformin), α -glucosidase inhibitors (acarbose) and glitazones (troglitazone and pioglitazone); (l) preparations of interferons (interferon alpha-2a, interferon-2B, interferon alpha-N3, interferon beta-1a, interferon beta-1b, interferon gamma-1b); (m) antiviral compounds such as efavirenz, nevirapine, indinavir, ganciclovir, lamivudine, famciclovir, and zalcitabine; (o) other compound such as 5-aminosalicylic acid and prodrugs thereof, antimetabolites such as azathioprine and 6-mercaptopurine, and cytotoxic cancer chemotherapeutic agents. The weight ratio of the compound of the present invention to the second active ingredient may be varied and will depend upon the effective doses of each ingredient. Generally, an effective dose of each will

be used. Thus, for example, when a compound of the present invention is combined with an NSAID the weight ratio of the compound of the present invention to the NSAID will generally range from about 1000:1 to about 1:1000, preferably about 200:1 to about 1:200. Combinations of a compound of the present invention and other active ingredients will generally also be within the aforementioned range, but in each case, an effective dose of each active ingredient should be used.

The compounds are administered to a mammal in a therapeutically effective amount. By "therapeutically effective amount" it is meant an amount of a compound of Formula I that, when administered alone or in combination with an additional therapeutic agent to a mammal, is effective to prevent or ameliorate the thromboembolic disease condition or the progression of the disease.

Dosage and Formulation

The compounds of this invention can be administered in such oral dosage forms as tablets, capsules (each of which includes sustained release or timed release formulations), pills, powders, granules, elixirs, tinctures, suspensions, syrups, and emulsions. They may also be administered in intravenous (bolus or infusion), intraperitoneal, subcutaneous, or intramuscular form, all using dosage forms well known to those of ordinary skill in the pharmaceutical arts. They can be administered alone, but generally will be administered with a pharmaceutical carrier selected on the basis of the chosen route of administration and standard pharmaceutical practice.

The dosage regimen for the compounds of the present invention will, of course, vary depending upon known factors, such as the pharmacodynamic characteristics of the particular agent and its mode and route of administration; the species, age, sex, health, medical condition, and weight of the recipient; the nature and extent of the symptoms; the kind of concurrent treatment; the frequency

of treatment; the route of administration, the renal and hepatic function of the patient, and the effect desired. A physician or veterinarian can determine and prescribe the effective amount of the drug required to prevent, counter, or arrest the progress of the thromboembolic disorder.

By way of general guidance, the daily oral dosage of each active ingredient, when used for the indicated effects, will range between about 0.001 to 1000 mg/kg of body weight, preferably between about 0.01 to 100 mg/kg of body weight per day, and most preferably between about 1.0 to 20 mg/kg/day. Intravenously, the most preferred doses will range from about 1 to about 10 mg/kg/minute during a constant rate infusion. Compounds of this invention may be administered in a single daily dose, or the total daily dosage may be administered in divided doses of two, three, or four times daily.

Compounds of this invention can be administered in intranasal form via topical use of suitable intranasal vehicles, or via transdermal routes, using transdermal skin patches. When administered in the form of a transdermal delivery system, the dosage administration will, of course, be continuous rather than intermittent throughout the dosage regimen.

The compounds are typically administered in admixture with suitable pharmaceutical diluents, excipients, or carriers (collectively referred to herein as pharmaceutical carriers) suitably selected with respect to the intended form of administration, that is, oral tablets, capsules, elixirs, syrups and the like, and consistent with conventional pharmaceutical practices.

For instance, for oral administration in the form of a tablet or capsule, the active drug component can be combined with an oral, non-toxic, pharmaceutically acceptable, inert carrier such as lactose, starch, sucrose, glucose, methyl cellulose, magnesium stearate, dicalcium phosphate, calcium sulfate, mannitol, sorbitol and the like; for oral administration in liquid form, the oral drug

components can be combined with any oral, non-toxic, pharmaceutically acceptable inert carrier such as ethanol, glycerol, water, and the like. Moreover, when desired or necessary, suitable binders, lubricants, disintegrating agents, and coloring agents can also be incorporated into the mixture. Suitable binders include starch, gelatin, natural sugars such as glucose or beta-lactose, corn sweeteners, natural and synthetic gums such as acacia, tragacanth, or sodium alginate, carboxymethylcellulose, polyethylene glycol, waxes, and the like. Lubricants used in these dosage forms include sodium oleate, sodium stearate, magnesium stearate, sodium benzoate, sodium acetate, sodium chloride, and the like. Disintegrators include, without limitation, starch, methyl cellulose, agar, bentonite, xanthan gum, and the like.

The compounds of the present invention can also be administered in the form of liposome delivery systems, such as small unilamellar vesicles, large unilamellar vesicles, and multilamellar vesicles. Liposomes can be formed from a variety of phospholipids, such as cholesterol, stearylamine, or phosphatidylcholines.

Compounds of the present invention may also be coupled with soluble polymers as targetable drug carriers. Such polymers can include polyvinylpyrrolidone, pyran copolymer, polyhydroxypropylmethacrylamide-phenol, polyhydroxyethylaspartamidephenol, or polyethyleneoxide-polylysine substituted with palmitoyl residues. Furthermore, the compounds of the present invention may be coupled to a class of biodegradable polymers useful in achieving controlled release of a drug, for example, polylactic acid, polyglycolic acid, copolymers of polylactic and polyglycolic acid, polyepsilon caprolactone, polyhydroxy butyric acid, polyorthoesters, polyacetals, polydihydropyrans, polycyanoacylates, and crosslinked or amphipathic block copolymers of hydrogels.

Dosage forms (pharmaceutical compositions) suitable for administration may contain from about 1 milligram to

about 100 milligrams of active ingredient per dosage unit. In these pharmaceutical compositions the active ingredient will ordinarily be present in an amount of about 0.5-95% by weight based on the total weight of the composition.

5 Gelatin capsules may contain the active ingredient and powdered carriers, such as lactose, starch, cellulose derivatives, magnesium stearate, stearic acid, and the like. Similar diluents can be used to make compressed tablets. Both tablets and capsules can be manufactured as
10 sustained release products to provide for continuous release of medication over a period of hours. Compressed tablets can be sugar coated or film coated to mask any unpleasant taste and protect the tablet from the atmosphere, or enteric coated for selective disintegration
15 in the gastrointestinal tract.

Liquid dosage forms for oral administration can contain coloring and flavoring to increase patient acceptance.

In general, water, a suitable oil, saline, aqueous
20 dextrose (glucose), and related sugar solutions and glycols such as propylene glycol or polyethylene glycols are suitable carriers for parenteral solutions. Solutions for parenteral administration preferably contain a water
25 soluble salt of the active ingredient, suitable stabilizing agents, and if necessary, buffer substances. Antioxidizing agents such as sodium bisulfite, sodium sulfite, or ascorbic acid, either alone or combined, are suitable stabilizing agents. Also used are citric acid and its salts and sodium EDTA. In addition, parenteral solutions
30 can contain preservatives, such as benzalkonium chloride, methyl- or propyl-paraben, and chlorobutanol.

Suitable pharmaceutical carriers are described in Remington's Pharmaceutical Sciences, Mack Publishing Company, a standard reference text in this field.

35 Representative useful pharmaceutical dosage-forms for administration of the compounds of this invention can be illustrated as follows:

Capsules

A large number of unit capsules can be prepared by filling standard two-piece hard gelatin capsules each with 100 milligrams of powdered active ingredient, 150
5 milligrams of lactose, 50 milligrams of cellulose, and 6 milligrams magnesium stearate.

Soft Gelatin Capsules

A mixture of active ingredient in a digestable oil such as soybean oil, cottonseed oil or olive oil may be
10 prepared and injected by means of a positive displacement pump into gelatin to form soft gelatin capsules containing 100 milligrams of the active ingredient. The capsules should be washed and dried.

Tablets

15 Tablets may be prepared by conventional procedures so that the dosage unit is 100 milligrams of active ingredient, 0.2 milligrams of colloidal silicon dioxide, 5 milligrams of magnesium stearate, 275 milligrams of microcrystalline cellulose, 11 milligrams of starch and
20 98.8 milligrams of lactose. Appropriate coatings may be applied to increase palatability or delay absorption.

Injectable

A parenteral composition suitable for administration by injection may be prepared by stirring 1.5% by weight of
25 active ingredient in 10% by volume propylene glycol and water. The solution should be made isotonic with sodium chloride and sterilized.

Suspension

An aqueous suspension can be prepared for oral
30 administration so that each 5 mL contain 100 mg of finely divided active ingredient, 200 mg of sodium carboxymethyl cellulose, 5 mg of sodium benzoate, 1.0 g of sorbitol solution, U.S.P., and 0.025 mL of vanillin.

Where the compounds of this invention are combined
35 with other anticoagulant agents, for example, a daily dosage may be about 0.1 to 100 milligrams of the compound of Formula I and about 1 to 7.5 milligrams of the second

anticoagulant, per kilogram of patient body weight. For a tablet dosage form, the compounds of this invention generally may be present in an amount of about 5 to 10 milligrams per dosage unit, and the second anti-coagulant in an amount of about 1 to 5 milligrams per dosage unit.

Where two or more of the foregoing second therapeutic agents are administered with the compound of Formula I, generally the amount of each component in a typical daily dosage and typical dosage form may be reduced relative to the usual dosage of the agent when administered alone, in view of the additive or synergistic effect of the therapeutic agents when administered in combination.

Particularly when provided as a single dosage unit, the potential exists for a chemical interaction between the combined active ingredients. For this reason, when the compound of Formula I and a second therapeutic agent are combined in a single dosage unit they are formulated such that although the active ingredients are combined in a single dosage unit, the physical contact between the active ingredients is minimized (that is, reduced). For example, one active ingredient may be enteric coated. By enteric coating one of the active ingredients, it is possible not only to minimize the contact between the combined active ingredients, but also, it is possible to control the release of one of these components in the gastrointestinal tract such that one of these components is not released in the stomach but rather is released in the intestines. One of the active ingredients may also be coated with a material which effects a sustained-release throughout the gastrointestinal tract and also serves to minimize physical contact between the combined active ingredients. Furthermore, the sustained-released component can be additionally enteric coated such that the release of this component occurs only in the intestine. Still another approach would involve the formulation of a combination product in which the one component is coated with a sustained and/or enteric release polymer, and the other

component is also coated with a polymer such as a low-viscosity grade of hydroxypropyl methylcellulose (HPMC) or other appropriate materials as known in the art, in order to further separate the active components. The polymer
5 coating serves to form an additional barrier to interaction with the other component.

These as well as other ways of minimizing contact between the components of combination products of the present invention, whether administered in a single dosage
10 form or administered in separate forms but at the same time by the same manner, will be readily apparent to those skilled in the art, once armed with the present disclosure.

As will be appreciated by one of skill in the art, numerous modifications and variations of the present
15 invention are possible in light of the above teachings. It is therefore to be understood that within the scope of the appended claims, the invention may be practiced otherwise than as specifically described herein.

What is Claimed is:

1. A compound of formula (I):

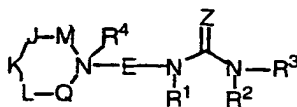

(I)

or stereoisomers or pharmaceutically acceptable salts thereof, wherein:

- 10 M is absent or selected from CH₂, CHR⁵, CHR¹³, CR¹³R¹³, and CR⁵R¹³;

Q is selected from CH₂, CHR⁵, CHR¹³, CR¹³R¹³, and CR⁵R¹³;

- 15 J, K, and L are independently selected from CH₂, CHR⁵, CHR⁶, CR⁶R⁶ and CR⁵R⁶;

with the provisos:

- 20 1) at least one of M, J, K, L, or Q contains an R⁵;
and

2) when M is absent, J is selected from CH₂, CHR⁵, CHR¹³, and CR⁵R¹³;

25

Z is selected from O and S;

E is -(CHR⁷)-(CHR⁹)_v-(CHR¹¹)-;

- 30 R¹ and R² are independently selected from H, C₁₋₈ alkyl, C₂₋₈ alkenyl, C₂₋₈ alkynyl, (CH₂)_rC₃₋₆ cycloalkyl, and a (CH₂)_r-C₃₋₁₀ carbocyclic residue substituted with 0-5 R^a;

- 35 R^a, at each occurrence, is selected from C₁₋₄ alkyl, C₂₋₈ alkenyl, C₂₋₈ alkynyl, (CH₂)_rC₃₋₆ cycloalkyl, Cl, Br, I,

F, $(\text{CF}_2)_r\text{CF}_3$, NO_2 , CN , $(\text{CH}_2)_r\text{NR}^b\text{R}^b$, $(\text{CH}_2)_r\text{OH}$, $(\text{CH}_2)_r\text{OR}^c$,
 $(\text{CH}_2)_r\text{SH}$, $(\text{CH}_2)_r\text{SR}^c$, $(\text{CH}_2)_r\text{C}(\text{O})\text{R}^b$, $(\text{CH}_2)_r\text{C}(\text{O})\text{NR}^b\text{R}^b$,
 $(\text{CH}_2)_r\text{NR}^b\text{C}(\text{O})\text{R}^b$, $(\text{CH}_2)_r\text{C}(\text{O})\text{OR}^b$, $(\text{CH}_2)_r\text{OC}(\text{O})\text{R}^c$,
 $(\text{CH}_2)_r\text{CH}(\text{=NR}^b)\text{NR}^b\text{R}^b$, $(\text{CH}_2)_r\text{NHC}(\text{=NR}^b)\text{NR}^b\text{R}^b$, $(\text{CH}_2)_r\text{S}(\text{O})_p\text{R}^c$,
5 $(\text{CH}_2)_r\text{S}(\text{O})_2\text{NR}^b\text{R}^b$, $(\text{CH}_2)_r\text{NR}^b\text{S}(\text{O})_2\text{R}^c$, and $(\text{CH}_2)_r\text{phenyl}$;

R^b , at each occurrence, is selected from H, C_{1-6} alkyl, C_{3-6} cycloalkyl, and phenyl;

10 R^c , at each occurrence, is selected from C_{1-6} alkyl, C_{3-6} cycloalkyl, and phenyl;

alternatively, R^2 and R^3 join to form a 5, 6, or 7-membered ring substituted with 0-3 R^a ;

15 R^3 is selected from a $(\text{CR}^{3'}\text{R}^{3''})_r\text{-C}_{3-10}$ carbocyclic residue substituted with 0-5 R^{15} and a $(\text{CR}^{3'}\text{R}^{3''})_r\text{-5-10}$ membered heterocyclic system containing 1-4 heteroatoms selected from N, O, and S, substituted with 0-3 R^{15} ;

20 $\text{R}^{3'}$ and $\text{R}^{3''}$, at each occurrence, are selected from H, C_{1-6} alkyl, $(\text{CH}_2)_r\text{C}_{3-6}$ cycloalkyl, and phenyl;

R^4 is absent, taken with the nitrogen to which it is attached to form an N-oxide, or selected from C_{1-8} alkyl, C_{2-8} alkenyl, C_{2-8} alkynyl, $(\text{CH}_2)_r\text{C}_{3-6}$ cycloalkyl, $(\text{CH}_2)_q\text{C}(\text{O})\text{R}^{4b}$, $(\text{CH}_2)_q\text{C}(\text{O})\text{NR}^{4a}\text{R}^{4a'}$, $(\text{CH}_2)_q\text{C}(\text{O})\text{OR}^{4b}$, and a $(\text{CH}_2)_r\text{-C}_{3-10}$ carbocyclic residue substituted with 0-3 R^{4c} ;

30 R^{4a} and $\text{R}^{4a'}$, at each occurrence, are selected from H, C_{1-6} alkyl, $(\text{CH}_2)_r\text{C}_{3-6}$ cycloalkyl, and phenyl;

R^{4b} , at each occurrence, is selected from C_{1-6} alkyl, C_{2-8} alkenyl, $(\text{CH}_2)_r\text{C}_{3-6}$ cycloalkyl, C_{2-8} alkynyl, and phenyl;

- R^{4c} , at each occurrence, is selected from C_{1-6} alkyl, C_{2-8} alkenyl, C_{2-8} alkynyl, C_{3-6} cycloalkyl, Cl, F, Br, I, CN, NO_2 , $(CF_2)_rCF_3$, $(CH_2)_rOC_{1-5}$ alkyl, $(CH_2)_rOH$, $(CH_2)_rSC_{1-5}$ alkyl, $(CH_2)_rNR^{4a}R^{4a'}$, and $(CH_2)_rphenyl$;
- 5 alternatively, R^4 joins with R^7 , R^9 , or R^{11} to form a 5, 6 or 7 membered piperidinium spirocycle or pyrrolidinium spirocycle substituted with 0-3 R^a ;
- 10 R^5 is selected from a $(CR^{5'}R^{5''})_t-C_{3-10}$ carbocyclic residue substituted with 0-5 R^{16} and a $(CR^{5'}R^{5''})_t-5-10$ membered heterocyclic system containing 1-4 heteroatoms selected from N, O, and S, substituted with 0-3 R^{16} ;
- 15 $R^{5'}$ and $R^{5''}$, at each occurrence, are selected from H, C_{1-6} alkyl, $(CH_2)_rC_{3-6}$ cycloalkyl, and phenyl;
- R^6 , at each occurrence, is selected from C_{1-6} alkyl, C_{2-8} alkenyl, C_{2-8} alkynyl, $(CH_2)_rC_{3-6}$ cycloalkyl, $(CF_2)_rCF_3$,
- 20 CN, $(CH_2)_rNR^{6a}R^{6a'}$, $(CH_2)_rOH$, $(CH_2)_rOR^{6b}$, $(CH_2)_rSH$, $(CH_2)_rSR^{6b}$, $(CH_2)_rC(O)OH$, $(CH_2)_rC(O)R^{6b}$, $(CH_2)_rC(O)NR^{6a}R^{6a'}$, $(CH_2)_rNR^{6d}C(O)R^{6a}$, $(CH_2)_rC(O)OR^{6b}$, $(CH_2)_rOC(O)R^{6b}$, $(CH_2)_rS(O)_pR^{6b}$, $(CH_2)_rS(O)_2NR^{6a}R^{6a'}$, $(CH_2)_rNR^{6d}S(O)_2R^{6b}$, and $(CH_2)_tphenyl$ substituted with 0-
- 25 3 R^{6c} ;
- R^{6a} and $R^{6a'}$, at each occurrence, are selected from H, C_{1-6} alkyl, C_{3-6} cycloalkyl, and phenyl substituted with 0-3
- 30 R^{6c} ;
- R^{6b} , at each occurrence, is selected from C_{1-6} alkyl, C_{3-6} cycloalkyl, and phenyl substituted with 0-3 R^{6c} ;
- R^{6c} , at each occurrence, is selected from C_{1-6} alkyl, C_{3-6}
- 35 cycloalkyl, Cl, F, Br, I, CN, NO_2 , $(CF_2)_rCF_3$, $(CH_2)_rOC_{1-5}$ alkyl, $(CH_2)_rOH$, $(CH_2)_rSC_{1-5}$ alkyl, and $(CH_2)_rNR^{6d}R^{6d}$;

R^{6d}, at each occurrence, is selected from H, C₁₋₆ alkyl, and C₃₋₆ cycloalkyl;

5 with the proviso that when any of J, K, or L is CR⁶R⁶ and R⁶ is halogen, cyano, nitro, or bonded to the carbon to which it is attached through a heteroatom, the other R⁶ is not halogen, cyano, or bonded to the carbon to which it is attached through a heteroatom;

10 R⁷ at each occurrence, is selected from H or alternatively R⁷ joins with R⁴ to form a 5, 6, or 7 membered piperidinium spirocycle or pyrrolidinium spirocycle substituted with 0-3R^a;

15 R⁹ at each occurrence, is selected from H or alternatively R⁹ joins with R⁴ to form a 5, 6, or 7 membered piperidinium spirocycle or pyrrolidinium spirocycle substituted with 0-3R^a;

20 R¹¹ at each occurrence, is selected from H, C₁₋₆alkyl, C₂₋₈alkenyl, C₂₋₈alkynyl, and a (CH₂)_r-C₃₋₁₀ carbocyclic residue substituted with 0-5 R^{11c}, or alternatively R¹¹ joins with R⁴ to form a 5, 6, or 7 membered
25 piperidinium spirocycle or pyrrolidinium spirocycle substituted with 0-3R^a;

R^{11a} and R^{11a'}, at each occurrence, are selected from H, C₁₋₆ alkyl, C₂₋₈ alkenyl, C₂₋₈ alkynyl, a (CH₂)_r-C₃₋₁₀
30 carbocyclic residue substituted with 0-5 R^{11e}, and a (CH₂)_r-5-10 membered heterocyclic system containing 1-4 heteroatoms selected from N, O, and S, substituted with 0-3 R^{11e};

35 R^{11b}, at each occurrence, is selected from C₁₋₆ alkyl, C₂₋₈ alkenyl, C₂₋₈ alkynyl, a (CH₂)_r-C₃₋₆ carbocyclic residue substituted with 0-2 R^{11e}, and a (CH₂)_r-5-6 membered

heterocyclic system containing 1-4 heteroatoms
selected from N, O, and S, substituted with 0-3 R^{11e};

- 5 R^{11c}, at each occurrence, is selected from C₁₋₆ alkyl, C₂₋₈
alkenyl, C₂₋₈ alkynyl, (CH₂)_rC₃₋₆ cycloalkyl, Cl, Br, I,
F, (CF₂)_rCF₃, NO₂, CN, (CH₂)_rNR^{11f}R^{11f}, (CH₂)_rOH,
(CH₂)_rOC₁₋₄ alkyl, (CH₂)_rSC₁₋₄ alkyl, (CH₂)_rC(O)OH,
(CH₂)_rC(O)R^{11b}, (CH₂)_rC(O)NR^{11f}R^{11f}, (CH₂)_rNR^{11f}C(O)R^{11a},
10 (CH₂)_rC(O)OC₁₋₄ alkyl, (CH₂)_rOC(O)R^{11b},
(CH₂)_rC(=NR^{11f})NR^{11f}R^{11f}, (CH₂)_rNHC(=NR^{11f})NR^{11f}R^{11f},
(CH₂)_rS(O)_pR^{11b}, (CH₂)_rS(O)₂NR^{11f}R^{11f},
(CH₂)_rNR^{11f}S(O)₂R^{11b}, and (CH₂)_rphenyl substituted with
0-3 R^{11e};
- 15 R^{11e}, at each occurrence, is selected from C₁₋₆ alkyl, C₂₋₈
alkenyl, C₂₋₈ alkynyl, C₃₋₆ cycloalkyl, Cl, F, Br, I,
CN, NO₂, (CF₂)_rCF₃, (CH₂)_rOC₁₋₅ alkyl, OH, SH, (CH₂)_rSC₁₋₅
alkyl, (CH₂)_rNR^{11f}R^{11f}, and (CH₂)_rphenyl;
- 20 R^{11f}, at each occurrence, is selected from H, C₁₋₆ alkyl,
and C₃₋₆ cycloalkyl;
- R¹³, at each occurrence, is selected from C₁₋₆ alkyl, C₂₋₈
alkenyl, C₂₋₈ alkynyl, C₃₋₆ cycloalkyl, (CF₂)_wCF₃,
25 (CH₂)_qNR^{13a}R^{13a'}, (CH₂)_qOH, (CH₂)_qOR^{13b}, (CH₂)_qSH,
(CH₂)_qSR^{13b}, (CH₂)_wC(O)OH, (CH₂)_wC(O)R^{13b},
(CH₂)_wC(O)NR^{13a}R^{13a'}, (CH₂)_qNR^{13d}C(O)R^{13a},
(CH₂)_wC(O)OR^{13b}, (CH₂)_qOC(O)R^{13b}, (CH₂)_wS(O)_pR^{13b},
(CH₂)_wS(O)₂NR^{13a}R^{13a'}, (CH₂)_qNR^{13d}S(O)₂R^{13b}, and (CH₂)_w-
30 phenyl substituted with 0-3 R^{13c};
- R^{13a} and R^{13a'}, at each occurrence, are selected from H, C₁₋₆
alkyl, C₃₋₆ cycloalkyl, and phenyl substituted with 0-3
R^{13c};
- 35 R^{13b}, at each occurrence, is selected from C₁₋₆ alkyl, C₃₋₆
cycloalkyl, and phenyl substituted with 0-3 R^{13c};

5 R^{13c} , at each occurrence, is selected from C_{1-6} alkyl, C_{3-6} cycloalkyl, Cl, F, Br, I, CN, NO_2 , $(CF_2)_rCF_3$, $(CH_2)_rOC_{1-5}$ alkyl, $(CH_2)_rOH$, $(CH_2)_rSC_{1-5}$ alkyl, and $(CH_2)_rNR^{13d}R^{13d}$;

R^{13d} , at each occurrence, is selected from H, C_{1-6} alkyl, and C_{3-6} cycloalkyl;

10 R^{15} , at each occurrence, is selected from C_{1-8} alkyl, $(CH_2)_rC_{3-6}$ cycloalkyl, Cl, Br, I, F, NO_2 , CN, $(CHR')_rNR^{15a}R^{15a'}$, $(CHR')_rOH$, $(CHR')_rO(CHR')_rR^{15d}$, $(CHR')_rSH$, $(CHR')_rC(O)H$, $(CHR')_rS(CHR')_rR^{15d}$, $(CHR')_rC(O)OH$, $(CHR')_rC(O)(CHR')_rR^{15b}$,
 15 $(CHR')_rC(O)NR^{15a}R^{15a'}$, $(CHR')_rNR^{15f}C(O)(CHR')_rR^{15b}$, $(CHR')_rNR^{15f}C(O)NR^{15f}R^{15f}$, $(CHR')_rC(O)O(CHR')_rR^{15d}$, $(CHR')_rOC(O)(CHR')_rR^{15b}$, $(CHR')_rC(=NR^{15f})NR^{15a}R^{15a'}$, $(CHR')_rNHC(=NR^{15f})NR^{15f}R^{15f}$, $(CHR')_rS(O)_p(CHR')_rR^{15b}$, $(CHR')_rS(O)_2NR^{15a}R^{15a'}$, $(CHR')_rNR^{15f}S(O)_2(CHR')_rR^{15b}$, C_{1-6}
 20 haloalkyl, C_{2-8} alkenyl substituted with 0-3 R' , C_{2-8} alkynyl substituted with 0-3 R' , $(CHR')_r$ phenyl substituted with 0-3 R^{15e} , and a $(CH_2)_r$ -5-10 membered heterocyclic system containing 1-4 heteroatoms selected from N, O, and S, substituted with 0-2 R^{15e} ;

25 R' , at each occurrence, is selected from H, C_{1-6} alkyl, C_{2-8} alkenyl, C_{2-8} alkynyl, $(CH_2)_rC_{3-6}$ cycloalkyl, and $(CH_2)_r$ phenyl substituted with R^{15e} ;

30 R^{15a} and $R^{15a'}$, at each occurrence, are selected from H, C_{1-6} alkyl, C_{2-8} alkenyl, C_{2-8} alkynyl, a $(CH_2)_r$ - C_{3-10} carbocyclic residue substituted with 0-5 R^{15e} , and a $(CH_2)_r$ -5-10 membered heterocyclic system containing 1-4 heteroatoms selected from N, O, and S, substituted
 35 with 0-2 R^{15e} ;

- R^{15b} , at each occurrence, is selected from C_{1-6} alkyl, C_{2-8} alkenyl, C_{2-8} alkynyl, a $(CH_2)_r-C_{3-6}$ carbocyclic residue substituted with 0-3 R^{15e} , and $(CH_2)_r-5-6$ membered heterocyclic system containing 1-4 heteroatoms selected from N, O, and S, substituted with 0-2 R^{15e} ;
- R^{15d} , at each occurrence, is selected from C_{2-8} alkenyl, C_{2-8} alkynyl, C_{1-6} alkyl substituted with 0-3 R^{15e} , a $(CH_2)_r-C_{3-10}$ carbocyclic residue substituted with 0-3 R^{15e} , and a $(CH_2)_r-5-6$ membered heterocyclic system containing 1-4 heteroatoms selected from N, O, and S, substituted with 0-3 R^{15e} ;
- R^{15e} , at each occurrence, is selected from C_{1-6} alkyl, C_{2-8} alkenyl, C_{2-8} alkynyl, $(CH_2)_r-C_{3-6}$ cycloalkyl, Cl, F, Br, I, CN, NO_2 , $(CF_2)_rCF_3$, $(CH_2)_rOC_{1-5}$ alkyl, OH, SH, $(CH_2)_rSC_{1-5}$ alkyl, $(CH_2)_rNR^{15f}R^{15f}$, and $(CH_2)_r$ phenyl;
- R^{15f} , at each occurrence, is selected from H, C_{1-6} alkyl, C_{3-6} cycloalkyl, and phenyl;
- R^{16} , at each occurrence, is selected from C_{1-8} alkyl, C_{2-8} alkenyl, C_{2-8} alkynyl, $(CH_2)_r-C_{3-6}$ cycloalkyl, Cl, Br, I, F, NO_2 , CN, $(CHR')_rNR^{16a}R^{16a'}$, $(CHR')_rOH$, $(CHR')_rO(CHR')_rR^{16d}$, $(CHR')_rSH$, $(CHR')_rC(O)H$, $(CHR')_rS(CHR')_rR^{16d}$, $(CHR')_rC(O)OH$, $(CHR')_rC(O)(CHR')_rR^{16b}$, $(CHR')_rC(O)NR^{16a}R^{16a'}$, $(CHR')_rNR^{16f}C(O)(CHR')_rR^{16b}$, $(CHR')_rC(O)O(CHR')_rR^{16d}$, $(CHR')_rOC(O)(CHR')_rR^{16b}$, $(CHR')_rC(=NR^{16f})NR^{16a}R^{16a'}$, $(CHR')_rNHC(=NR^{16f})NR^{16f}R^{16f}$, $(CHR')_rS(O)_p(CHR')_rR^{16b}$, $(CHR')_rS(O)_2NR^{16a}R^{16a'}$, $(CHR')_rNR^{16f}S(O)_2(CHR')_rR^{16b}$, C_{1-6} haloalkyl, C_{2-8} alkenyl substituted with 0-3 R' , C_{2-8} alkynyl substituted with 0-3 R' , and $(CHR')_r$ phenyl substituted with 0-3 R^{16e} ;
- R^{16a} and $R^{16a'}$, at each occurrence, are selected from H, C_{1-6} alkyl, C_{2-8} alkenyl, C_{2-8} alkynyl, a $(CH_2)_r-C_{3-10}$

carbocyclic residue substituted with 0-5 R^{16e}, and a (CH₂)_r-5-10 membered heterocyclic system containing 1-4 heteroatoms selected from N, O, and S, substituted with 0-2 R^{16e};

5

R^{16b}, at each occurrence, is selected from C₁₋₆ alkyl, C₂₋₈ alkenyl, C₂₋₈ alkynyl, a (CH₂)_rC₃₋₆ carbocyclic residue substituted with 0-3 R^{16e}, and a (CH₂)_r-5-6 membered heterocyclic system containing 1-4 heteroatoms selected from N, O, and S, substituted with 0-2 R^{16e};

10

R^{16d}, at each occurrence, is selected from C₂₋₈ alkenyl, C₂₋₈ alkynyl, C₁₋₆ alkyl substituted with 0-3 R^{16e}, a (CH₂)_r-C₃₋₁₀ carbocyclic residue substituted with 0-3 R^{16e}, and a (CH₂)_r-5-6 membered heterocyclic system containing 1-4 heteroatoms selected from N, O, and S, substituted with 0-3 R^{16e};

15

R^{16e}, at each occurrence, is selected from C₁₋₆ alkyl, C₂₋₈ alkenyl, C₂₋₈ alkynyl, (CH₂)_rC₃₋₆ cycloalkyl, Cl, F, Br, I, CN, NO₂, (CF₂)_rCF₃, (CH₂)_rOC₁₋₅ alkyl, OH, SH, (CH₂)_rSC₁₋₅ alkyl, (CH₂)_rNR^{16f}R^{16f}, and (CH₂)_rphenyl;

20

R^{16f}, at each occurrence, is selected from H, C₁₋₅ alkyl, and C₃₋₆ cycloalkyl, and phenyl;

25

v is selected from 1 and 2;

t is selected from 1 and 2;

30

w is selected from 0 and 1;

r is selected from 0, 1, 2, 3, 4, and 5;

35 q is selected from 1, 2, 3, 4, and 5; and

p is selected from 0, 1, 2, and 3.

2. The compound of claim 1, wherein:

5 R⁴ is absent, taken with the nitrogen to which it is attached to form an N-oxide, or selected from C₁₋₈ alkyl, (CH₂)_rC₃₋₆ cycloalkyl, and (CH₂)_r-phenyl substituted with 0-3 R^{4c};

10 R^{4c}, at each occurrence, is selected from C₁₋₆ alkyl, C₂₋₈ alkenyl, C₂₋₈ alkynyl, C₃₋₆ cycloalkyl, Cl, F, Br, I, CN, NO₂, (CF₂)_rCF₃, (CH₂)_rOC₁₋₅ alkyl, (CH₂)_rOH, (CH₂)_rSC₁₋₅ alkyl, (CH₂)_rNR^{4a}R^{4a'}, and (CH₂)_rphenyl;

15 alternatively, R⁴ joins with R⁷, R⁹, or R¹¹ to form a 5, 6 or 7 membered piperidinium spirocycle or pyrrolidinium spirocycle substituted with 0-3 R^a;

R¹ and R² are independently selected from H and C₁₋₄ alkyl;

20 R⁶, at each occurrence, is selected from C₁₋₄ alkyl, C₂₋₈ alkenyl, C₂₋₈ alkynyl, (CH₂)_rC₃₋₆ cycloalkyl, (CF₂)_rCF₃, CN, (CH₂)_rOH, (CH₂)_rOR^{6b}, (CH₂)_rC(O)R^{6b}, (CH₂)_rC(O)NR^{6a}R^{6a'}, (CH₂)_rNR^{6d}C(O)R^{6a}, and (CH₂)_tphenyl substituted with 0-3 R^{6c};

25 R^{6a} and R^{6a'}, at each occurrence, are selected from H, C₁₋₆ alkyl, C₃₋₆ cycloalkyl, and phenyl substituted with 0-3 R^{6c};

30 R^{6b}, at each occurrence, is selected from C₁₋₆ alkyl, C₃₋₆ cycloalkyl, and phenyl substituted with 0-3 R^{6c};

35 R^{6c}, at each occurrence, is selected from C₁₋₆ alkyl, C₃₋₆ cycloalkyl, Cl, F, Br, I, CN, NO₂, (CF₂)_rCF₃, (CH₂)_rOC₁₋₅ alkyl, (CH₂)_rOH, (CH₂)_rSC₁₋₅ alkyl, and (CH₂)_rNR^{6d}R^{6d};

R^{6d}, at each occurrence, is selected from H, C₁₋₆ alkyl, and C₃₋₆ cycloalkyl;

5 R¹³, at each occurrence, is selected from C₁₋₄ alkyl, C₃₋₆ cycloalkyl, (CH₂)_wNR^{13a}R^{13a'}, (CH₂)OH, (CH₂)OR^{13b}, (CH₂)_wC(O)R^{13b}, (CH₂)_wC(O)NR^{13a}R^{13a'}, (CH₂)NR^{13d}C(O)R^{13a}, (CH₂)_wS(O)₂NR^{13a}R^{13a'}, (CH₂)NR^{13d}S(O)₂R^{13b}, and (CH₂)_w-phenyl substituted with 0-3 R^{13c};

10 R^{13a} and R^{13a'}, at each occurrence, are selected from H, C₁₋₆ alkyl, C₃₋₆ cycloalkyl, and phenyl substituted with 0-3 R^{13c};

15 R^{13b}, at each occurrence, is selected from C₁₋₆ alkyl, C₃₋₆ cycloalkyl, and phenyl substituted with 0-3 R^{13c};

R^{13c}, at each occurrence, is selected from C₁₋₆ alkyl, C₃₋₆ cycloalkyl, Cl, F, Br, I, CN, NO₂, (CF₂)_rCF₃, (CH₂)_rOC₁₋₅ alkyl, (CH₂)_rOH, and (CH₂)_rNR^{13d}R^{13d};

20 R^{13d}, at each occurrence, is selected from H, C₁₋₆ alkyl, and C₃₋₆ cycloalkyl;

v is selected from 1 and 2;

25 q is selected from 1, 2, and 3; and

r is selected from 0, 1, 2, and 3.

30 3. The compound of claim 2, wherein:

R³ is selected from a (CR^{3'}H)_r-carbocyclic residue substituted with 0-5 R¹⁵, wherein the carbocyclic residue is selected from phenyl, C₃₋₆ cycloalkyl, naphthyl, and adamantyl; and a (CR^{3'}H)_r-heterocyclic system substituted with 0-3 R¹⁵, wherein the heterocyclic system is selected from pyridinyl,

thiophenyl, furanyl, indazolyl, benzothiazolyl,
 benzimidazolyl, benzothiophenyl, benzofuranyl,
 benzoxazolyl, benzisoxazolyl, quinolinyl,
 isoquinolinyl, imidazolyl, indolyl, indolinyl,
 5 isoindolyl, isothiadiazolyl, isoxazolyl, piperidinyl,
 pyrrazolyl, 1,2,4-triazolyl, 1,2,3-triazolyl,
 tetrazolyl, thiadiazolyl, thiazolyl, oxazolyl,
 pyrazinyl, and pyrimidinyl; and

10 R⁵ is selected from (CR^{5'}H)_t-phenyl substituted with 0-5
 R¹⁶; and a (CR^{5'}H)_t-heterocyclic system substituted
 with 0-3 R¹⁶, wherein the heterocyclic system is
 selected from pyridinyl, thiophenyl, furanyl,
 indazolyl, benzothiazolyl, benzimidazolyl,
 15 benzothiophenyl, benzofuranyl, benzoxazolyl,
 benzisoxazolyl, quinolinyl, isoquinolinyl, imidazolyl,
 indolyl, indolinyl, isoindolyl, isothiadiazolyl,
 isoxazolyl, piperidinyl, pyrrazolyl, 1,2,4-triazolyl,
 1,2,3-triazolyl, tetrazolyl, thiadiazolyl, thiazolyl,
 20 oxazolyl, pyrazinyl, and pyrimidinyl.

4. The compound of claim 3, wherein the compound of
 formula (I) is:



R¹⁶, at each occurrence, is selected from C₁₋₈ alkyl,
 (CH₂)_rC₃₋₆ cycloalkyl, CF₃, Cl, Br, I, F,
 (CH₂)_rNR^{16a}R^{16a'}, NO₂, CN, OH, (CH₂)_rOR^{16d},
 30 (CH₂)_rC(O)R^{16b}, (CH₂)_rC(O)NR^{16a}R^{16a'}, (CH₂)_rNR^{16f}C(O)R^{16b},
 (CH₂)_rS(O)_pR^{16b}, (CH₂)_rS(O)₂NR^{16a}R^{16a'},
 (CH₂)_rNR^{16f}S(O)₂R^{16b}, and (CH₂)_rphenyl substituted with
 0-3 R^{16e};

R^{16a} and R^{16a'}, at each occurrence, are selected from H, C₁₋₆ alkyl, C₃₋₆ cycloalkyl, and (CH₂)_rphenyl substituted with 0-3 R^{16e};

5 R^{16b}, at each occurrence, is selected from H, C₁₋₆ alkyl, C₃₋₆ cycloalkyl, and (CH₂)_rphenyl substituted with 0-3 R^{16e};

10 R^{16d}, at each occurrence, is selected from C₁₋₆ alkyl and phenyl;

R^{16e}, at each occurrence, is selected from C₁₋₆ alkyl, Cl, F, Br, I, CN, NO₂, (CF₂)_rCF₃, OH, and (CH₂)_rOC₁₋₅ alkyl; and

15 R^{16f}, at each occurrence, is selected from H, and C₁₋₅ alkyl.

20 5. The compound of claim 3, wherein the compound formula (I) is:

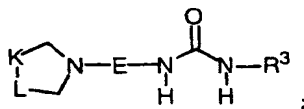

25 R¹⁶, at each occurrence, is selected from C₁₋₈ alkyl, (CH₂)_rC₃₋₆ cycloalkyl, CF₃, Cl, Br, I, F, (CH₂)_rNR^{16a}R^{16a'}, NO₂, CN, OH, (CH₂)_rOR^{16d}, (CH₂)_rC(O)R^{16b}, (CH₂)_rC(O)NR^{16a}R^{16a'}, (CH₂)_rNR^{16f}C(O)R^{16b}, (CH₂)_rS(O)_pR^{16b}, (CH₂)_rS(O)₂NR^{16a}R^{16a'}, (CH₂)_rNR^{16f}S(O)₂R^{16b}, and (CH₂)_rphenyl substituted with 0-3 R^{16e};

30 R^{16a} and R^{16a'}, at each occurrence, are selected from H, C₁₋₆ alkyl, C₃₋₆ cycloalkyl, and (CH₂)_rphenyl substituted with 0-3 R^{16e};

R^{16b}, at each occurrence, is selected from H, C₁₋₆ alkyl, C₃₋₆ cycloalkyl, and (CH₂)_rphenyl substituted with 0-3 R^{16e};

5 R^{16d}, at each occurrence, is selected from C₁₋₆ alkyl and phenyl;

R^{16e}, at each occurrence, is selected from C₁₋₆ alkyl, Cl, F, Br, I, CN, NO₂, (CF₂)_rCF₃, OH, and (CH₂)_rOC₁₋₅ alkyl;
10 and

R^{16f}, at each occurrence, is selected from H, and C₁₋₅ alkyl.

15 6. The compound of claim 4, wherein:

R⁵ is CH₂phenyl substituted with 0-3 R¹⁶;

E is -CH₂-(CH₂)-(CH₂);

20

r is selected from 0, 1, and 2.

7. The compound of claim 5, wherein:

25 E is -CH₂-(CHR⁹)-CHR¹¹;

R⁵ is CH₂phenyl substituted with 0-3 R¹⁶; and

r is selected from 0, 1, and 2.

30

8. The compound of claim 6, wherein:

J is selected from CH₂ and CHR⁵;

35 K is selected from CH₂ and CHR⁵;

L is selected from CH₂ and CHR⁵;

- R^3 is a C_{3-10} carbocyclic residue substituted with 0-3 R^{15} , wherein the carbocyclic residue is selected from cyclopropyl, cyclopentyl, cyclohexyl, phenyl, naphthyl and adamantyl, and a $(CR^{3'H})_r$ -heterocyclic system substituted with 0-3 R^{15} , wherein the heterocyclic system is selected from pyridinyl, thiophenyl, furanyl, indazolyl, benzothiazolyl, benzimidazolyl, benzothiophenyl, benzofuranyl, benzoxazolyl, benzisoxazolyl, quinolinyl, isoquinolinyl, imidazolyl, indolyl, indolinyl, isoindolyl, isothiadiazolyl, isoxazolyl, piperidinyl, pyrazolyl, 1,2,4-triazolyl, 1,2,3-triazolyl, tetrazolyl, thiadiazolyl, thiazolyl, oxazolyl, pyrazinyl, and pyrimidinyl; and
- R^{15} , at each occurrence, is selected from C_{1-8} alkyl, $(CH_2)_rC_{3-6}$ cycloalkyl, CF_3 , Cl, Br, I, F, $(CH_2)_rNR^{15a}R^{15a'}$, NO_2 , CN, OH, $(CH_2)_rOR^{15d}$, $(CH_2)_rC(O)R^{15b}$, $(CH_2)_rC(O)NR^{15a}R^{15a'}$, $(CH_2)_rNR^{15f}C(O)R^{15b}$, $(CH_2)_rS(O)_pR^{15b}$, $(CH_2)_rS(O)_2NR^{15a}R^{15a'}$, $(CH_2)_rNR^{15f}S(O)_2R^{15b}$, $(CH_2)_r$ phenyl substituted with 0-3 R^{15e} , and a $(CH_2)_r$ -5-6 membered heterocyclic system containing 1-4 heteroatoms selected from N, O, and S, substituted with 0-2 R^{15e} ;
- R^{15a} and $R^{15a'}$, at each occurrence, are selected from H, C_{1-6} alkyl, C_{3-6} cycloalkyl, and $(CH_2)_r$ phenyl substituted with 0-3 R^{15e} ;
- R^{15b} , at each occurrence, is selected from H, C_{1-6} alkyl, C_{3-6} cycloalkyl, and $(CH_2)_r$ phenyl substituted with 0-3 R^{15e} ;
- R^{15d} , at each occurrence, is selected from C_{1-6} alkyl and phenyl;

R^{15e}, at each occurrence, is selected from C₁₋₆ alkyl, Cl, F, Br, I, CN, NO₂, (CF₂)_rCF₃, OH, and (CH₂)_rOC₁₋₅ alkyl; and

5 R^{15f}, at each occurrence, is selected from H, and C₁₋₅ alkyl.

9. The compound of claim 7, wherein:

10 K is selected from CH₂ and CHR⁵;

L is selected from CH₂ and CHR⁵;

R³ is a C₃₋₁₀ carbocyclic residue substituted with 0-3 R¹⁵,
 15 wherein the carbocyclic residue is selected from cyclopropyl, cyclopentyl, cyclohexyl, phenyl, naphthyl and adamantyl, and a (CR^{3'}H)_r-heterocyclic system substituted with 0-3 R¹⁵, wherein the heterocyclic system is selected from pyridinyl, thiophenyl,
 20 furanyl, indazolyl, benzothiazolyl, benzimidazolyl, benzothiophenyl, benzofuranyl, benzoxazolyl, benzisoxazolyl, quinolinyl, isoquinolinyl, imidazolyl, indolyl, indolinyl, isoindolyl, isothiadiazolyl, isoxazolyl, piperidinyl, pyrazolyl, 1,2,4-triazolyl,
 25 1,2,3-triazolyl, tetrazolyl, thiadiazolyl, thiazolyl, oxazolyl, pyrazinyl, and pyrimidinyl; and

R¹⁵, at each occurrence, is selected from C₁₋₈ alkyl, (CH₂)_rC₃₋₆ cycloalkyl, CF₃, Cl, Br, I, F,
 30 (CH₂)_rNR^{15a}R^{15a'}, NO₂, CN, OH, (CH₂)_rOR^{15d}, (CH₂)_rC(O)R^{15b}, (CH₂)_rC(O)NR^{15a}R^{15a'}, (CH₂)_rNR^{15f}C(O)R^{15b}, (CH₂)_rS(O)_pR^{15b}, (CH₂)_rS(O)₂NR^{15a}R^{15a'}, (CH₂)_rNR^{15f}S(O)₂R^{15b}, (CH₂)_rphenyl substituted with 0-3 R^{15e}, and a (CH₂)_r-5-6 membered heterocyclic system
 35 containing 1-4 heteroatoms selected from N, O, and S, substituted with 0-2 R^{15e};

- R^{15a} and R^{15a'}, at each occurrence, are selected from H, C₁₋₆ alkyl, C₃₋₆ cycloalkyl, and (CH₂)_rphenyl substituted with 0-3 R^{15e};
- 5 R^{15b}, at each occurrence, is selected from H, C₁₋₆ alkyl, C₃₋₆ cycloalkyl, and (CH₂)_rphenyl substituted with 0-3 R^{15e};
- R^{15d}, at each occurrence, is selected from C₁₋₆ alkyl and
10 phenyl;
- R^{15e}, at each occurrence, is selected from C₁₋₆ alkyl, Cl, F, Br, I, CN, NO₂, (CF₂)_rCF₃, OH, and (CH₂)_rOC₁₋₅ alkyl;
and
15
- R^{15f}, at each occurrence, is selected from H, and C₁₋₅ alkyl
10. The compound of claim 3, wherein:
- 20 M is absent or selected from CH₂;
- Q is CH₂;
- J is CH₂;
- 25 K and L are independently selected from CH₂ and CHR^s;
- Z is O;
- 30 R¹ is H;
- R² is H;
- R³ is a C₃₋₁₀ carbocyclic residue substituted with 0-3 R¹⁵,
35 wherein the carbocyclic residue is selected from cyclopropyl, cyclopentyl, cyclohexyl, phenyl, naphthyl and adamantyl, and a (CR^{3'}H)_r-heterocyclic system

substituted with 0-3 R¹⁵, wherein the heterocyclic system is selected from pyridinyl, thiophenyl, furanyl, indazolyl, benzothiazolyl, benzimidazolyl, benzothiophenyl, benzofuranyl, benzoxazolyl, benzisoxazolyl, quinolinyl, isoquinolinyl, imidazolyl, indolyl, indolinyl, isoindolyl, isothiadiazolyl, isoxazolyl, piperidinyl, pyrrazolyl, 1,2,4-triazolyl, 1,2,3-triazolyl, tetrazolyl, thiadiazolyl, thiazolyl, oxazolyl, pyrazinyl, and pyrimidinyl; and

R⁵ is selected from a CH₂-C₃₋₁₀ carbocyclic residue substituted with 1-5 R¹⁶ and a heterocyclic system substituted with 0-3 R¹⁵, wherein the heterocyclic system is selected from pyridinyl, thiophenyl, furanyl, indazolyl, benzothiazolyl, benzimidazolyl, benzothiophenyl, benzofuranyl, benzoxazolyl, benzisoxazolyl, quinolinyl, isoquinolinyl, imidazolyl, indolyl, indolinyl, isoindolyl, isothiadiazolyl, isoxazolyl, piperidinyl, pyrrazolyl, 1,2,4-triazolyl, 1,2,3-triazolyl, tetrazolyl, thiadiazolyl, thiazolyl, oxazolyl, pyrazinyl, and pyrimidinyl

11. The compound of claim 1 and pharmaceutically acceptable salt forms thereof, wherein the compound of formula (I) is selected from:

N-(2-hydroxymethylphenyl)-N'-[3-[4-(phenylmethyl)-1-piperidinyl]propyl]urea,

N-(3-carboethoxyphenyl)-N'-[3-[4-(phenylmethyl)-1-piperidinyl]propyl]urea,

N-(3-cyanophenyl)-N'-[3-[4-(phenylmethyl)-1-piperidinyl]propyl]urea,

N-[4-(benzyloxy)phenyl]-N'-[3-[4-(phenylmethyl)-1-piperidinyl]propyl]urea,

- N-(3-iodophenyl)-N'-[3-[4-(phenylmethyl)-1-piperidinyl]propyl]urea,
- 5 N-(3-methoxyphenyl)-N'-[3-[4-(phenylmethyl)-1-piperidinyl]propyl]urea,
- N-phenyl-N'-[3-[4-(phenylmethyl)-1-piperidinyl]propyl]urea,
- 10 N-(4-carboethoxyphenyl)-N'-[3-[4-(phenylmethyl)-1-piperidinyl]propyl]urea,
- N-(4-fluorophenyl)-N'-[3-[4-(phenylmethyl)-1-piperidinyl]propyl]urea,
- 15 N-(2-methoxyphenyl)-N'-[3-[4-(phenylmethyl)-1-piperidinyl]propyl]urea,
- N-(4-methoxyphenyl)-N'-[3-[4-(phenylmethyl)-1-piperidinyl]propyl]urea,
- 20 N-(3-cyanophenyl)-N'-[3-[4-(4-fluorophenylmethyl)-1-piperidinyl]propyl]urea,
- 25 N-(4-fluorophenyl)-N'-[3-[4-(4-fluorophenylmethyl)-1-piperidinyl]propyl]urea,
- N-(4-carboethoxyphenyl)-N'-[3-[4-(4-fluorophenylmethyl)-1-piperidinyl]propyl]urea,
- 30 N-(3-cyanophenyl)-N'-[3-[4-((3,4-methylenedioxy)phenylmethyl)-1-piperidinyl]propyl]urea,
- 35 N-(3-methoxyphenyl)-N'-[3-[4-(4-fluorophenylmethyl)-1-piperidinyl]propyl]urea,

- N-(3-carboethoxyphenyl)-N'-[3-[4-((3,4-methylenedioxy)phenylmethyl)-1-piperidinyl]propyl]urea,
- 5 N-(3-methoxyphenyl)-N'-[3-[4-((3,4-methylenedioxy)phenylmethyl)-1-piperidinyl]propyl]urea,
- N-(3-methoxyphenyl)-N'-[3-[4-((3-methoxy)phenylmethyl)-1-piperidinyl]propyl]urea,
- 10 N-(3-cyanophenyl)-N'-[3-[4-(4-fluorophenylmethyl)-1-methyl-1-piperidinium]propyl]urea iodide,
- N-(4-cyanophenyl)-N'-[3-[4-(phenylmethyl)-1-piperidinyl]propyl]urea,
- 15 N-(4-fluorophenyl)-N'-[3-[4-((3,4-methylenedioxy)phenylmethyl)-1-piperidinyl]propyl]urea,
- N-(4-fluorophenyl)-N'-[3-[4-(2,4-bisfluorophenylmethyl)-1-piperidinyl]propyl]urea,
- 20 N-(3-methoxyphenyl)-N'-[3-[4-(2,4-bisfluorophenylmethyl)-1-piperidinyl]propyl]urea,
- 25 N-(3-cyanophenyl)-N'-[3-[4-(2,4-bisfluorophenylmethyl)-1-piperidinyl]propyl]urea,
- N-(phenylmethyl)-N'-[3-[4-(4-fluorophenylmethyl)-1-piperidinyl]propyl]urea,
- 30 N-[1-(2-phenylethyl)]-N'-[3-[4-(4-fluorophenylmethyl)-1-piperidinyl]propyl]urea,
- N-(2-fluorophenyl)-N'-[3-[4-(4-fluorophenylmethyl)-1-piperidinyl]propyl]urea,
- 35 N-(3-fluorophenyl)-N'-[3-[4-(4-fluorophenylmethyl)-1-piperidinyl]propyl]urea,

- N-(cyclohexyl)-N'-[3-[4-(4-fluorophenylmethyl)-1-piperidinyl]propyl]urea,
- 5 N-[1-[trans-2-phenylcyclopropyl]-N'-[3-[4-(4-fluorophenylmethyl)-1-piperidinyl]propyl]urea,
- 10 N-(3-methoxyphenyl)-N'-[3-[4-(4-methylphenylmethyl)-1-piperidinyl]propyl]urea,
- N-(3-cyanophenyl)-N'-[3-[4-(4-methylphenylmethyl)-1-piperidinyl]propyl]urea,
- 15 N-(3-cyanophenyl)-N'-[3-[4-(4-chlorophenylmethyl)-1-piperidinyl]propyl]urea,
- N-(3-methoxyphenyl)-N'-[3-[4-(3-methoxyphenylmethyl)-1-piperidinyl]propyl]urea,
- 20 N-(3-cyanophenyl)-N'-[3-[4-(3-methoxyphenylmethyl)-1-piperidinyl]propyl]urea,
- N-(4-fluorophenyl)-N'-[3-[4-(3-methoxyphenylmethyl)-1-piperidinyl]propyl]urea,
- 25 N-(4-carboethoxyphenyl)-N'-[3-[4-(3-methoxyphenylmethyl)-1-piperidinyl]propyl]urea,
- 30 N-(3-cyanophenyl)-N'-[3-[4-(2-fluorophenylmethyl)-1-piperidinyl]propyl]urea,
- N-(3-fluorophenyl)-N'-[3-[4-(3-methoxyphenylmethyl)-1-piperidinyl]propyl]urea,
- 35 N-(3-carboethoxyphenyl)-N'-[3-[4-(3-methoxyphenylmethyl)-1-piperidinyl]propyl]urea,

- N-[3-acetylphenyl]-N'-[3-[4-(4-fluorophenylmethyl)-1-piperidinyl]propyl]urea,
- 5 N-[3-(alpha-hydroxyethyl)phenyl]-N'-[3-[4-(4-fluorophenylmethyl)-1-piperidinyl]propyl]urea,
- N-[4-acetylphenyl]-N'-[3-[4-(4-fluorophenylmethyl)-1-piperidinyl]propyl]urea,
- 10 N-(3-methoxyphenyl)-N'-[3-[4-(phenylmethyl)-1-piperidinyl]propyl]urea,
- cis-N-(3-methoxyphenyl)-N'-[3-[2,4-bis(phenylmethyl)-1-piperidinyl]propyl]urea,
- 15 N-(3-acetylphenyl)-N'-[3-[4-(4-fluorophenylmethyl)-1-piperidinyl]propyl]urea,
- N-(3-methoxyphenyl)-N'-[3-[4-(4-fluorophenylmethylydenyl)-1-piperidinyl]propyl]urea,
- 20 N-(4-acetylphenyl)-N'-[3-[4-(4-fluorophenylmethyl)-1-piperidinyl]propyl]urea,
- 25 N-(3-(1-hydroxyethyl)phenyl)-N'-[3-[4-(4-fluorophenylmethyl)-1-piperidinyl]propyl]urea hydrochloride,
- 30 N-(3-acetylphenyl)-N'-[3-[4-(4-fluorophenylmethyl)-3-(phenylmethyl)-1-piperidinyl]propyl]urea,
- N-(4-fluorophenyl)-N'-[3-[4-(4-fluorophenylmethyl)-3-(phenylmethyl)-1-piperidinyl]propyl]urea,
- 35 N-(3-methoxyphenyl)-N'-[3-[4-(4-fluorophenylmethyl)-3-(phenylmethyl)-1-piperidinyl]propyl]urea,

- N-(2-isopropylphenyl)-N'-[3-[4-(4-fluorophenylmethyl)-1-piperidinyl]propyl]urea,
- 5 N-(2-trifluoromethylphenyl)-N'-[3-[4-(4-fluorophenylmethyl)-1-piperidinyl]propyl]urea,
- N-(3-chlorophenyl)-N'-[3-[4-(4-fluorophenylmethyl)-1-piperidinyl]propyl]urea,
- 10 N-(3-trifluoromethylphenyl)-N'-[3-[4-(4-fluorophenylmethyl)-1-piperidinyl]propyl]urea,
- N-(2-chlorophenyl)-N'-[3-[4-(4-fluorophenylmethyl)-1-piperidinyl]propyl]urea,
- 15 N-(2,4-difluorophenyl)-N'-[3-[4-(4-fluorophenylmethyl)-1-piperidinyl]propyl]urea,
- N-(3-cyanophenyl)-N'-[3-[4-(4-fluorophenylmethyl)-1-piperidinyl]propyl]urea, hydrochloride,
- 20 N-(3-cyanophenyl)-N'-[3-[4-(naphth-1-ylmethyl)-1-piperidinyl]propyl]urea,
- 25 N-(4-fluorophenyl)-N'-[3-[4-(naphth-1-ylmethyl)-1-piperidinyl]propyl]urea,
- N-(3-methoxyphenyl)-N'-[3-[4-(naphth-1-ylmethyl)-1-piperidinyl]propyl]urea,
- 30 N-(3-cyanophenyl)-N'-[3-[4-(3-methylphenylmethyl)-1-piperidinyl]propyl]urea,
- N-(3-methoxyphenyl)-N'-[3-[4-(3-methylphenylmethyl)-1-piperidinyl]propyl]urea,
- 35 N-(4-cyanophenyl)-N'-[3-[4-(4-fluorophenylmethyl)-1-piperidinyl]propyl]urea,

- N-(4-fluorophenyl)-N'-[3-[4-(4-chlorophenyl)methyl-1-piperidinyl]propyl]urea,
- 5 N-(3-methoxyphenyl)-N'-[3-[4-(4-chlorophenyl)methyl-1-piperidinyl]propyl]urea,
- N-(3-cyanophenyl)-N'-[3-[4-(3,4-bisfluorophenyl)methyl-1-piperidinyl]propyl]urea,
- 10 N-(3-methoxyphenyl)-N'-[3-[4-(3,4-bisfluorophenyl)methyl-1-piperidinyl]propyl]urea,
- N-(4-fluorophenyl)-N'-[3-[4-(3,4-bisfluorophenyl)methyl-1-piperidinyl]propyl]urea,
- 15 N-(3-methoxyphenyl)-N'-[3-[4-(3-fluorophenyl)methyl-1-piperidinyl]propyl]urea,
- 20 N-(3-cyanophenyl)-N'-[3-[4-(3-chlorophenyl)methyl-1-piperidinyl]propyl]urea,
- N-(3-methoxyphenyl)-N'-[3-[4-(3-carbomethoxyphenyl)methyl-1-piperidinyl]propyl]urea,
- 25 N-(3-cyanophenyl)-N'-[3-[4-(3-carbomethoxyphenyl)methyl-1-piperidinyl]propyl]urea,
- N-(3-acetylphenyl)-N'-[3-[4-(4-fluorophenyl)methyl-1-piperidinyl]propyl]urea,
- 30 N-(3,5-diacetylphenyl)-N'-[3-[3-(4-fluorophenyl)methyl-1-piperidinyl]propyl]urea,
- 35 N-(3-acetylphenyl)-N'-[3-[3-(4-fluorophenyl)methyl-1-piperidinyl]propyl]urea,

- N-(3,5-diacetylphenyl)-N'-[3-[4-(4-fluorophenyl)methyl]-1-piperidinyl]propyl]urea,
- 5 N-(3-cyanophenyl)-N'-[1-phenyl-3-[4-(4-fluorophenylmethyl)-1-piperidinyl]propyl]urea,
- N-(3-methoxyphenyl)-N'-[1-phenyl-3-[4-(phenylmethyl)-1-piperidinyl]propyl]urea,
- 10 N-(3-cyanophenyl)-N'-[1-phenyl-3-[4-(phenylmethyl)-1-piperidinyl]propyl]urea,
- N-(1-adamantyl)-N'-[1-phenyl-3-[4-(phenylmethyl)-1-piperidinyl]propyl]urea,
- 15 N-(4-fluorophenyl)-N'-[1-phenyl-3-[4-(phenylmethyl)-1-piperidinyl]propyl]urea,
- N-(3-carboethoxyphenyl)-N'-[3-[3-(phenylmethyl)-1-piperidinyl]propyl]urea,
- 20 N-(3-cyanophenyl)-N'-[3-[3-(phenylmethyl)-1-piperidinyl]propyl]urea,
- 25 N-(4-fluorophenyl)-N'-[3-[3-(phenylmethyl)-1-piperidinyl]propyl]urea,
- N-phenyl-N'-[3-[3-(phenylmethyl)-1-piperidinyl]propyl]urea,
- 30 N-(1-adamantyl)-N'-[3-[3-(phenylmethyl)-1-piperidinyl]propyl]urea,
- N-(3-methoxyphenyl)-N'-[3-[3-(phenylmethyl)-1-piperidinyl]propyl]urea,
- 35 N-(4-carboethoxyphenyl)-N'-[3-[3-(phenylmethyl)-1-piperidinyl]propyl]urea,

- N-phenyl-N'-[3-[3-(4-fluorophenyl)methyl-1-piperidinyl]propyl]urea,
- 5 N-(3-cyanophenyl)-N'-[3-[3-(4-fluorophenyl)methyl-1-piperidinyl]propyl]urea,
- N-(1-adamantyl)-N'-[3-[3-(4-fluorophenyl)methyl-1-piperidinyl]propyl]urea,
- 10 N-(3-methoxyphenyl)-N'-[3-[3-(4-fluorophenyl)methyl-1-piperidinyl]propyl]urea,
- N-(3-carboethoxyphenyl)-N'-[3-[3-(4-fluorophenyl)methyl-1-piperidinyl]propyl]urea,
- 15 N-(4-fluorophenyl)-N'-[3-[3-(4-fluorophenyl)methyl-1-piperidinyl]propyl]urea,
- N-(3-cyanophenyl)-N'-[3-[3-[2-(phenyl)ethyl]-1-piperidinyl]propyl]urea,
- 20 N-(3-carboethoxyphenyl)-N'-[3-[3-[2-(phenyl)ethyl]-1-piperidinyl]propyl]urea,
- 25 N-(4-carboethoxyphenyl)-N'-[3-[3-[2-(phenyl)ethyl]-1-piperidinyl]propyl]urea,
- N-(4-fluorophenyl)-N'-[3-[3-[2-(phenyl)ethyl]-1-piperidinyl]propyl]urea,
- 30 N-phenyl-N'-[3-[3-[2-(phenyl)ethyl]-1-piperidinyl]propyl]urea,
- N-(1-adamantyl)-N'-[3-[3-[2-(phenyl)ethyl]-1-piperidinyl]propyl]urea,
- 35 N-(3-methoxyphenyl)-N'-[3-[3-[2-(phenyl)ethyl]-1-piperidinyl]propyl]urea,

- N-phenyl-N'-[3-[3-(4-fluorophenyl)methyl]-1-pyrrolinyl]propyl]urea,
- 5 N-(3-cyanophenyl)-N'-[3-[3-(4-fluorophenyl)methyl-1-pyrrolinyl]propyl]urea,
- N-(3-methoxyphenyl)-N'-[3-[3-(4-fluorophenyl)methyl-1-pyrrolinyl]propyl]urea,
- 10 N-(4-fluorophenyl)-N'-[3-[3-(4-fluorophenyl)methyl-1-pyrrolinyl]propyl]urea,
- N-(3-carboethoxyphenyl)-N'-[3-[3-(4-fluorophenyl)methyl-1-pyrrolinyl]propyl]urea,
- 15 N-(4-carboethoxyphenyl)-N'-[3-[3-(4-fluorophenyl)methyl-1-pyrrolinyl]propyl]urea,
- 20 N-(1-adamantyl)-N'-[3-[3-(4-fluorophenyl)methyl-1-pyrrolinyl]propyl]urea,
- N-phenyl-N'-[3-[3-(2-fluorophenyl)methyl-1-piperidinyl]propyl]urea,
- 25 N-(3-cyanophenyl)-N'-[3-[3-(2-fluorophenyl)methyl-1-piperidinyl]propyl]urea,
- N-(3-methoxyphenyl)-N'-[3-[3-(2-fluorophenyl)methyl-1-piperidinyl]propyl]urea,
- 30 N-(4-fluorophenyl)-N'-[3-[3-(2-fluorophenyl)methyl-1-piperidinyl]propyl]urea,
- 35 N-(3-methoxyphenyl)-N'-[3-[3-(3-fluorophenyl)methyl-1-piperidinyl]propyl]urea,

N-(3-cyanophenyl)-N'-[3-[3-(3-fluorophenyl)methyl-1-piperidinyl]propyl]urea,

5 N-(4-fluorophenyl)-N'-[3-[3-(3-fluorophenyl)methyl-1-piperidinyl]propyl]urea

N-[3-(1-methyltetrazol-5-yl)phenyl]-N'-[3-[4-(4-fluorophenylmethyl)-1-piperidinyl]propyl]urea,

10 N-[3-(1-methyltetrazol-5-yl)phenyl]-N'-[3-[3-(4-fluorophenylmethyl)-1-piperidinyl]propyl]urea,

N-[3,5-bis(1-methyltetrazol-5-yl)phenyl]-N'-[3-[4-(4-fluorophenylmethyl)-1-piperidinyl]propyl]urea,

15 N-[3,5-bis(1-methyltetrazol-5-yl)phenyl]-N'-[3-[3-(4-fluorophenylmethyl)-1-piperidinyl]propyl]urea,

N-[4-(1-methyltetrazol-5-yl)phenyl]-N'-[3-[4-(4-fluorophenylmethyl)-1-piperidinyl]propyl]urea, and

20 N-[4-(1-methyltetrazol-5-yl)phenyl]-N'-[3-[3-(4-fluorophenylmethyl)-1-piperidinyl]propyl]urea.

25

12. The compound of claim 1 and pharmaceutically acceptable salt forms thereof, wherein the compound of formula (I) is selected from:

30 N-(1-adamantyl)-N'-[3-[4-(phenylmethyl)-1-piperidinyl]propyl]urea, and

N-[1-(trans-2-phenylcyclopropyl)]-N'-[3-[4-(phenylmethyl)-1-piperidinyl]propyl]urea.

35

13. The compound of claim 1 and pharmaceutically acceptable salt forms thereof, wherein the compound of formula (I) is selected from:

- 5 N-(3-methoxyphenyl)-N'-[3-[1,4-bis(phenylmethyl)-1-piperidinium]propyl]urea bromide,
- N-(3-cyanophenyl)-N'-[3-[1,4-bis(phenylmethyl)-1-piperidinium]propyl]urea bromide,
- 10 N-(3-methoxyphenyl)-N'-[3-[1-methyl-4-(phenylmethyl)-1-piperidinium]propyl]urea bromide,
- N-(3-cyanophenyl)-N'-[3-[1-methyl-4-(phenylmethyl)-1-piperidinium]propyl]urea bromide,
- 15 N-(3-cyanophenyl)-N'-[3-[1-(carbomethoxymethyl)-4-(phenylmethyl)-1-piperidinium]propyl]urea bromide,
- 20 N-(4-fluorophenyl)-N'-[3-[1-methyl-4-(phenylmethyl)-1-piperidinium]propyl]urea bromide,
- N-(4-fluorophenyl)-N'-[3-[1,4-bis(phenylmethyl)-1-piperidinium]propyl]urea bromide,
- 25 N-(4-fluorophenyl)-N'-[3-[1-(carbomethoxymethyl)-4-(phenylmethyl)-1-piperidinium]propyl]urea bromide,
- N-(3-cyanophenyl)-N'-[3-[1-(cyanomethyl)-4-(phenylmethyl)-1-piperidinium]propyl]urea bromide,
- 30 N-(3-cyanophenyl)-N'-[3-[1-(phenylcarbonylmethyl)-4-(phenylmethyl)-1-piperidinium]propyl]urea bromide,
- 35 N-(2-methoxyphenyl)-N'-[3-[1-methyl-4-(phenylmethyl)-1-piperidinium]propyl]urea bromide,

N-(4-methoxyphenyl)-N'-[3-[1-methyl-4-(phenylmethyl)-1-piperidinium]propyl]urea bromide,

5 N-(3-methoxyphenyl)-N'-[3-[1-oxo-4-(phenylmethyl)-1-piperidinium]propyl]urea, and

N-(3-methoxyphenyl)-N'-[3-[1-methyl-4-(phenylmethyl)-1-piperidinium]propyl]urea iodide.

10 14. The compound of claim 1 and pharmaceutically acceptable salt forms thereof, wherein the compound of formula (I) is selected from:

15 N-(3-cyanophenyl)-N'-[4-[4-(phenylmethyl)-1-piperidinyl]butyl]urea,

N-(3-acetylphenyl)-N'-[4-[4-(4-fluorophenylmethyl)-1-piperidinyl]butyl]urea,

20 N-(3,5-diacetylphenyl)-N'-[4-[4-(4-fluorophenylmethyl)-1-piperidinyl]butyl]urea,

N-(3-cyanophenyl)-N'-[4-[4-(4-fluorophenylmethyl)-1-piperidinyl]butyl]urea,

25 N-(3-acetylphenyl)-N'-[4-[3-(4-fluorophenylmethyl)-1-piperidinyl]butyl]urea,

30 N-(3,5-diacetylphenyl)-N'-[4-[3-(4-fluorophenylmethyl)-1-piperidinyl]butyl]urea,

N-(3-cyanophenyl)-N'-[4-[3-(4-fluorophenylmethyl)-1-piperidinyl]butyl]urea,

35 N-(3-methoxyphenyl)-N'-[4-[3-(4-fluorophenylmethyl)-1-piperidinyl]butyl]urea,

N-(4-fluorophenyl)-N'-[4-[3-(4-fluorophenylmethyl)-1-piperidinyl]butyl]urea,

5 N-phenyl-N'-[4-[3-(4-fluorophenylmethyl)-1-piperidinyl]butyl]urea, N-[3-(1-methyltetrazol-5-yl)phenyl]-N'-[4-[4-(4-fluorophenylmethyl)-1-piperidinyl]butyl]urea,

10 N-[3-(1-methyltetrazol-5-yl)phenyl]-N'-[4-[3-(4-fluorophenylmethyl)-1-piperidinyl]butyl]urea,

N-[3,5-bis(1-methyltetrazol-5-yl)phenyl]-N'-[4-[4-(4-fluorophenylmethyl)-1-piperidinyl]butyl]urea,

15 N-[3,5-bis(1-methyltetrazol-5-yl)phenyl]-N'-[4-[3-(4-fluorophenylmethyl)-1-piperidinyl]butyl]urea,

N-(3-carbomethoxyphenyl)-N'-[4-[4-(phenylmethyl)-1-piperidinyl]butyl]urea,

20 N-(3-iodophenyl)-N'-[4-[4-(phenylmethyl)-1-piperidinyl]butyl]urea,

N-[1-(4-benzyloxyphenyl)]-N'-[4-[4-(phenylmethyl)-1-piperidinyl]butyl]urea,

25 N-(1-adamantyl)-N'-[4-[4-(phenylmethyl)-1-piperidinyl]butyl]urea,

30 N-(3-methoxyphenyl)-N'-[4-[4-(phenylmethyl)-1-piperidinyl]butyl]urea,

N-phenyl-N'-[4-[4-(phenylmethyl)-1-piperidinyl]butyl]urea,

35 N-(3-methoxyphenyl)-N'-[4-[4-(phenylmethyl)-1-piperidinyl]butyl]urea,

N-(4-carbomethoxyphenyl)-N'-[4-[4-(phenylmethyl)-1-piperidinyl]butyl]urea,

N-(4-cyanophenyl)-N'-[4-[4-(phenylmethyl)-1-piperidinyl]butyl]urea,

5 N-(3-acetylphenyl)-N'-{(2Z)-4-[3-(4-fluorobenzyl)-1-piperidinyl]-2-butenyl}urea,

N-(3-acetylphenyl)-N'-{(2E)-4-[3-(4-fluorobenzyl)-1-piperidinyl]-2-butenyl}urea,

10

N-(3-cyanophenyl)-N'-{(2Z)-4-[3-(4-fluorobenzyl)-1-piperidinyl]-2-butenyl}urea,

15 N-(4-fluorophenyl)-N'-{(2Z)-4-[3-(4-fluorobenzyl)-1-piperidinyl]-2-butenyl}urea, and

N-(3-acetylphenyl)-N'-{4-[3-(4-fluorobenzyl)-1-piperidinyl]-2-butynyl}urea

20

25 15. A pharmaceutical composition, comprising a pharmaceutically acceptable carrier and a therapeutically effective amount of a compound of claim 1-14.

30 16. A method for modulation of chemokine receptor activity comprising administering to a patient in need thereof a therapeutically effective amount of a compound of claim 1-14.

35 17. A method for treating or preventing inflammatory diseases, comprising administering to a patient in need thereof a therapeutically effective amount of a compound of claim 1-14.

18. A method for treating or preventing asthma, comprising administering to a patient in need thereof a therapeutically effective amount of a compound of claim 1-14.

5

19. A compound of formula (I):

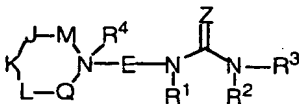

(I)

10 or stereoisomers or pharmaceutically acceptable salts thereof, wherein:

M is absent or selected from CH_2 , CHR^5 , CHR^{13} , $\text{CR}^{13}\text{R}^{13}$, and CR^5R^{13} ;

15

Q is selected from CH_2 , CHR^5 , CHR^{13} , $\text{CR}^{13}\text{R}^{13}$, and CR^5R^{13} ;

J, K, and L are independently selected from CH_2 , CHR^5 , CHR^6 , CR^6R^6 and CR^5R^6 ;

20

with the provisos:

1) at least one of M, J, K, L, or Q contains an R^5 ;
and

25

2) when M is absent, J is selected from CH_2 , CHR^5 , CHR^{13} , and CR^5R^{13} ;

Z is selected from NR^{1a} , CHCN , CHNO_2 , and $\text{C}(\text{CN})_2$;

30

R^{1a} is selected from H, C_{1-6} alkyl, C_{3-6} cycloalkyl, $\text{CONR}^{1b}\text{R}^{1b}$, OR^{1b} , CN, NO_2 , and $(\text{CH}_2)_w\text{phenyl}$;

R^{1b} is independently selected from H, C_{1-3} alkyl, C_{3-6} cycloalkyl, and phenyl;

35

E is $-(CR^7R^8)-(CR^9R^{10})_v-(CR^{11}R^{12})_-$;

R¹ and R² are independently selected from H, C₁₋₈ alkyl, C₂₋₈ alkenyl, C₂₋₈ alkynyl, (CH₂)_rC₃₋₆ cycloalkyl, and a
 5 (CH₂)_r-C₃₋₁₀ carbocyclic residue substituted with 0-5 R^a;

R^a, at each occurrence, is selected from C₁₋₄ alkyl, C₂₋₈ alkenyl, C₂₋₈ alkynyl, (CH₂)_rC₃₋₆ cycloalkyl, Cl, Br, I, F, (CF₂)_rCF₃, NO₂, CN, (CH₂)_rNR^bR^b, (CH₂)_rOH, (CH₂)_rOR^c,
 10 (CH₂)_rSH, (CH₂)_rSR^c, (CH₂)_rC(O)R^b, (CH₂)_rC(O)NR^bR^b, (CH₂)_rNR^bC(O)R^b, (CH₂)_rC(O)OR^b, (CH₂)_rOC(O)R^c, (CH₂)_rCH(=NR^b)NR^bR^b, (CH₂)_rNHC(=NR^b)NR^bR^b, (CH₂)_rS(O)_pR^c, (CH₂)_rS(O)₂NR^bR^b, (CH₂)_rNR^bS(O)₂R^c, and (CH₂)_rphenyl;

15 R^b, at each occurrence, is selected from H, C₁₋₆ alkyl, C₃₋₆ cycloalkyl, and phenyl;

20 R^c, at each occurrence, is selected from C₁₋₆ alkyl, C₃₋₆ cycloalkyl, and phenyl;

alternatively, R² and R³ join to form a 5, 6, or 7-membered ring substituted with 0-3 R^a;

25 R³ is selected from a (CR^{3'}R^{3''})_r-C₃₋₁₀ carbocyclic residue substituted with 0-5 R¹⁵ and a (CR^{3'}R^{3''})_r-5-10 membered heterocyclic system containing 1-4 heteroatoms selected from N, O, and S, substituted with 0-3 R¹⁵;

30 R^{3'} and R^{3''}, at each occurrence, are selected from H, C₁₋₆ alkyl, (CH₂)_rC₃₋₆ cycloalkyl, and phenyl;

35 R⁴ is absent, taken with the nitrogen to which it is attached to form an N-oxide, or selected from C₁₋₈ alkyl, C₂₋₈ alkenyl, C₂₋₈ alkynyl, (CH₂)_rC₃₋₆ cycloalkyl, (CH₂)_qC(O)R^{4b}, (CH₂)_qC(O)NR^{4a}R^{4a'},

$(\text{CH}_2)_q\text{C}(\text{O})\text{OR}^{4b}$, and a $(\text{CH}_2)_r\text{-C}_{3-10}$ carbocyclic residue substituted with 0-3 R^{4c} ;

5 R^{4a} and $\text{R}^{4a'}$, at each occurrence, are selected from H, C_{1-6} alkyl, $(\text{CH}_2)_r\text{C}_{3-6}$ cycloalkyl, and phenyl;

R^{4b} , at each occurrence, is selected from C_{1-6} alkyl, C_{2-8} alkenyl, $(\text{CH}_2)_r\text{C}_{3-6}$ cycloalkyl, C_{2-8} alkynyl, and phenyl;

10

R^{4c} , at each occurrence, is selected from C_{1-6} alkyl, C_{2-8} alkenyl, C_{2-8} alkynyl, C_{3-6} cycloalkyl, Cl, F, Br, I, CN, NO_2 , $(\text{CF}_2)_r\text{CF}_3$, $(\text{CH}_2)_r\text{OC}_{1-5}$ alkyl, $(\text{CH}_2)_r\text{OH}$, $(\text{CH}_2)_r\text{SC}_{1-5}$ alkyl, $(\text{CH}_2)_r\text{NR}^{4a}\text{R}^{4a'}$, and $(\text{CH}_2)_r\text{phenyl}$;

15

alternatively, R^4 joins with R^7 , R^9 , or R^{11} to form a 5, 6 or 7 membered piperidinium spirocycle or pyrrolidinium spirocycle substituted with 0-3 R^a ;

20 R^5 is selected from a $(\text{CR}^{5'}\text{R}^{5''})_t\text{-C}_{3-10}$ carbocyclic residue substituted with 0-5 R^{16} and a $(\text{CR}^{5'}\text{R}^{5''})_t\text{-5-10}$ membered heterocyclic system containing 1-4 heteroatoms selected from N, O, and S, substituted with 0-3 R^{16} ;

25 $\text{R}^{5'}$ and $\text{R}^{5''}$, at each occurrence, are selected from H, C_{1-6} alkyl, $(\text{CH}_2)_r\text{C}_{3-6}$ cycloalkyl, and phenyl;

30 R^6 , at each occurrence, is selected from C_{1-6} alkyl, C_{2-8} alkenyl, C_{2-8} alkynyl, $(\text{CH}_2)_r\text{C}_{3-6}$ cycloalkyl, $(\text{CF}_2)_r\text{CF}_3$, CN, $(\text{CH}_2)_r\text{NR}^{6a}\text{R}^{6a'}$, $(\text{CH}_2)_r\text{OH}$, $(\text{CH}_2)_r\text{OR}^{6b}$, $(\text{CH}_2)_r\text{SH}$, $(\text{CH}_2)_r\text{SR}^{6b}$, $(\text{CH}_2)_r\text{C}(\text{O})\text{OH}$, $(\text{CH}_2)_r\text{C}(\text{O})\text{R}^{6b}$, $(\text{CH}_2)_r\text{C}(\text{O})\text{NR}^{6a}\text{R}^{6a'}$, $(\text{CH}_2)_r\text{NR}^{6d}\text{C}(\text{O})\text{R}^{6a}$, $(\text{CH}_2)_r\text{C}(\text{O})\text{OR}^{6b}$, $(\text{CH}_2)_r\text{OC}(\text{O})\text{R}^{6b}$, $(\text{CH}_2)_r\text{S}(\text{O})_p\text{R}^{6b}$, $(\text{CH}_2)_r\text{S}(\text{O})_2\text{NR}^{6a}\text{R}^{6a'}$, $(\text{CH}_2)_r\text{NR}^{6ds}(\text{O})_2\text{R}^{6b}$, and $(\text{CH}_2)_t\text{phenyl}$ substituted with 0-3 R^{6c} ;

35

R^{6a} and $\text{R}^{6a'}$, at each occurrence, are selected from H, C_{1-6}

alkyl, C₃₋₆ cycloalkyl, and phenyl substituted with 0-3 R^{6c};

5 R^{6b}, at each occurrence, is selected from C₁₋₆ alkyl, C₃₋₆ cycloalkyl, and phenyl substituted with 0-3 R^{6c};

10 R^{6c}, at each occurrence, is selected from C₁₋₆ alkyl, C₃₋₆ cycloalkyl, Cl, F, Br, I, CN, NO₂, (CF₂)_rCF₃, (CH₂)_rOC₁₋₅ alkyl, (CH₂)_rOH, (CH₂)_rSC₁₋₅ alkyl, and (CH₂)_rNR^{6d}R^{6d};

15 R^{6d}, at each occurrence, is selected from H, C₁₋₆ alkyl, and C₃₋₆ cycloalkyl;

20 R⁷, is selected from H, C₁₋₆ alkyl, C₂₋₈ alkenyl, C₂₋₈ alkynyl, (CH₂)_qOH, (CH₂)_qSH, (CH₂)_qOR^{7d}, (CH₂)_qSR^{7d}, (CH₂)_qNR^{7a}R^{7a'}, (CH₂)_rC(O)OH, (CH₂)_rC(O)R^{7b}, (CH₂)_rC(O)NR^{7a}R^{7a'}, (CH₂)_qNR^{7a}C(O)R^{7a}, (CH₂)_qNR^{7a}C(O)H, (CH₂)_rC(O)OR^{7b}, (CH₂)_qOC(O)R^{7b}, (CH₂)_qS(O)_pR^{7b}, (CH₂)_qS(O)₂NR^{7a}R^{7a'}, (CH₂)_qNR^{7a}S(O)₂R^{7b}, C₁₋₆ haloalkyl, a (CH₂)_r-C₃₋₁₀ carbocyclic residue substituted with 0-3 R^{7c}, and a (CH₂)_r-5-10 membered heterocyclic system containing 1-4 heteroatoms selected from N, O, and S, substituted with 0-2 R^{7c};

25 R^{7a} and R^{7a'}, at each occurrence, are selected from H, C₁₋₆ alkyl, C₂₋₈ alkenyl, C₂₋₈ alkynyl, a (CH₂)_r-C₃₋₁₀ carbocyclic residue substituted with 0-5 R^{7e}, and a (CH₂)_r-5-10 membered heterocyclic system containing 1-4 heteroatoms selected from N, O, and S, substituted with 0-3 R^{7e};

30 R^{7b}, at each occurrence, is selected from C₁₋₆ alkyl, C₂₋₈ alkenyl, C₂₋₈ alkynyl, a (CH₂)_r-C₃₋₆ carbocyclic residue substituted with 0-2 R^{7e}, and a (CH₂)_r-5-6 membered heterocyclic system containing 1-4 heteroatoms selected from N, O, and S, substituted with 0-3 R^{7e};

R^{7c} , at each occurrence, is selected from C_{1-6} alkyl, C_{2-8} alkenyl, C_{2-8} alkynyl, $(CH_2)_r C_{3-6}$ cycloalkyl, Cl, Br, I, F, $(CF_2)_r CF_3$, NO_2 , CN, $(CH_2)_r NR^{7f} R^{7f}$, $(CH_2)_r OH$, $(CH_2)_r OC_{1-4}$ alkyl, $(CH_2)_r SC_{1-4}$ alkyl, $(CH_2)_r C(O)OH$,
 5 $(CH_2)_r C(O)R^{7b}$, $(CH_2)_r C(O)NR^{7f} R^{7f}$, $(CH_2)_r NR^{7f} C(O)R^{7a}$, $(CH_2)_r C(O)OC_{1-4}$ alkyl, $(CH_2)_r OC(O)R^{7b}$, $(CH_2)_r C(=NR^{7f})NR^{7f} R^{7f}$, $(CH_2)_r S(O)_p R^{7b}$, $(CH_2)_r NHC(=NR^{7f})NR^{7f} R^{7f}$, $(CH_2)_r S(O)_2 NR^{7f} R^{7f}$, $(CH_2)_r NR^{7f} S(O)_2 R^{7b}$, and $(CH_2)_r$ phenyl substituted with 0-
 10 3 R^{7e} ;

R^{7d} , at each occurrence, is selected from C_{1-6} alkyl substituted with 0-3 R^{7e} , alkenyl, alkynyl, and a C_{3-10} carbocyclic residue substituted with 0-3 R^{7c} ;

R^{7e} , at each occurrence, is selected from C_{1-6} alkyl, C_{2-8} alkenyl, C_{2-8} alkynyl, C_{3-6} cycloalkyl, Cl, F, Br, I, CN, NO_2 , $(CF_2)_r CF_3$, $(CH_2)_r OC_{1-5}$ alkyl, OH, SH, $(CH_2)_r SC_{1-5}$ alkyl, $(CH_2)_r NR^{7f} R^{7f}$, and $(CH_2)_r$ phenyl;

R^{7f} , at each occurrence, is selected from H, C_{1-6} alkyl, and C_{3-6} cycloalkyl;

R^8 is selected from H, C_{1-6} alkyl, C_{3-6} cycloalkyl, and $(CH_2)_r$ phenyl substituted with 0-3 R^{8a} ;

R^{8a} , at each occurrence, is selected from C_{1-6} alkyl, C_{2-8} alkenyl, C_{2-8} alkynyl, C_{3-6} cycloalkyl, Cl, F, Br, I, CN, NO_2 , $(CF_2)_r CF_3$, $(CH_2)_r OC_{1-5}$ alkyl, OH, SH, $(CH_2)_r SC_{1-5}$ alkyl, $(CH_2)_r NR^{7f} R^{7f}$, and $(CH_2)_r$ phenyl;

alternatively, R^7 and R^8 join to form C_{3-7} cycloalkyl, or $=NR^{8b}$;

R^{8b} is selected from H, C_{1-6} alkyl, C_{3-6} cycloalkyl, OH, CN, and $(CH_2)_r$ -phenyl;

- R^9 , is selected from H, C₁₋₆ alkyl, C₂₋₈ alkenyl, C₂₋₈ alkynyl, F, Cl, Br, I, NO₂, CN, (CH₂)_rOH, (CH₂)_rSH, (CH₂)_rOR^{9d}, (CH₂)_rSR^{9d}, (CH₂)_rNR^{9a}R^{9a'}, (CH₂)_rC(O)OH, (CH₂)_rC(O)R^{9b}, (CH₂)_rC(O)NR^{9a}R^{9a'}, (CH₂)_rNR^{9a}C(O)R^{9a}, (CH₂)_rNR^{9a}C(O)H, (CH₂)_rNR^{9a}C(O)NHR^{9a}, (CH₂)_rC(O)OR^{9b}, (CH₂)_rOC(O)R^{9b}, (CH₂)_rOC(O)NHR^{9a}, (CH₂)_rS(O)_pR^{9b}, (CH₂)_rS(O)₂NR^{9a}R^{9a'}, (CH₂)_rNR^{9a}S(O)₂R^{9b}, C₁₋₆ haloalkyl, a (CH₂)_r-C₃₋₁₀ carbocyclic residue substituted with 0-5 R^{9c}, and a (CH₂)_r-5-10 membered heterocyclic system containing 1-4 heteroatoms selected from N, O, and S, substituted with 0-3 R^{9c};
- R^{9a} and $R^{9a'}$, at each occurrence, are selected from H, C₁₋₆ alkyl, C₂₋₈ alkenyl, C₂₋₈ alkynyl, a (CH₂)_r-C₃₋₁₀ carbocyclic residue substituted with 0-5 R^{9e}, and a (CH₂)_r-5-10 membered heterocyclic system containing 1-4 heteroatoms selected from N, O, and S, substituted with 0-3 R^{9e};
- R^{9b} , at each occurrence, is selected from C₁₋₆ alkyl, C₂₋₈ alkenyl, C₂₋₈ alkynyl, a (CH₂)_r-C₃₋₆ carbocyclic residue substituted with 0-2 R^{9e}, and a (CH₂)_r-5-6 membered heterocyclic system containing 1-4 heteroatoms selected from N, O, and S, substituted with 0-3 R^{9e};
- R^{9c} , at each occurrence, is selected from C₁₋₆ alkyl, C₂₋₈ alkenyl, C₂₋₈ alkynyl, (CH₂)_rC₃₋₆ cycloalkyl, Cl, Br, I, F, (CF₂)_rCF₃, NO₂, CN, (CH₂)_rNR^{9f}R^{9f}, (CH₂)_rOH, (CH₂)_rOC₁₋₄ alkyl, (CH₂)_rSC₁₋₄ alkyl, (CH₂)_rC(O)OH, (CH₂)_rC(O)R^{9b}, (CH₂)_rC(O)NR^{9f}R^{9f}, (CH₂)_rNR^{9f}C(O)R^{9a}, (CH₂)_rC(O)OC₁₋₄ alkyl, (CH₂)_rOC(O)R^{9b}, (CH₂)_rC(=NR^{9f})NR^{9f}R^{9f}, (CH₂)_rS(O)_pR^{9b}, (CH₂)_rNHC(=NR^{9f})NR^{9f}R^{9f}, (CH₂)_rS(O)₂NR^{9f}R^{9f}, (CH₂)_rNR^{9f}S(O)₂R^{9b}, and (CH₂)_rphenyl substituted with 0-3 R^{9e};

- 5 R^{9d} , at each occurrence, is selected from C_{1-6} alkyl, C_{2-6} alkenyl, C_{2-6} alkynyl, a C_{3-10} carbocyclic residue substituted with 0-3 R^{9c} , and a 5-6 membered heterocyclic system containing 1-4 heteroatoms selected from the group consisting of N, O, and S substituted with 0-3 R^{9c} ;
- 10 R^{9e} , at each occurrence, is selected from C_{1-6} alkyl, C_{2-8} alkenyl, C_{2-8} alkynyl, $(CH_2)_r C_{3-6}$ cycloalkyl, Cl, F, Br, I, CN, NO_2 , $(CF_2)_r CF_3$, $(CH_2)_r OC_{1-5}$ alkyl, OH, SH, $(CH_2)_r SC_{1-5}$ alkyl, $(CH_2)_r NR^{9f} R^{9f}$, and $(CH_2)_r$ phenyl;
- 15 R^{9f} , at each occurrence, is selected from H, C_{1-6} alkyl, and C_{3-6} cycloalkyl;
- 20 R^{10} , is selected from H, C_{1-6} alkyl, C_{2-8} alkenyl, C_{2-8} alkynyl, F, Cl, Br, I, NO_2 , CN, $(CH_2)_r OH$, $(CH_2)_r OR^{10d}$, $(CH_2)_r SR^{10d}$, $(CH_2)_r NR^{10a} R^{10a'}$, $(CH_2)_r C(O)OH$, $(CH_2)_r C(O)R^{10b}$, $(CH_2)_r C(O)NR^{10a} R^{10a'}$, $(CH_2)_r NR^{10a} C(O)R^{10a}$, $(CH_2)_r NR^{10a} C(O)H$, $(CH_2)_r C(O)OR^{10b}$, $(CH_2)_r OC(O)R^{10b}$, $(CH_2)_r S(O)_p R^{10b}$, $(CH_2)_r S(O)_2 NR^{10a} R^{10a'}$, $(CH_2)_r NR^{10a} S(O)_2 R^{10b}$, C_{1-6} haloalkyl, a $(CH_2)_r$ - C_{3-10} carbocyclic residue substituted with 0-5 R^{10c} , and a $(CH_2)_r$ -5-10 membered heterocyclic system containing 1-4 heteroatoms selected from N, O, and S, substituted with 0-3 R^{10c} ;
- 25 R^{10a} and $R^{10a'}$, at each occurrence, are selected from H, C_{1-6} alkyl, C_{2-8} alkenyl, C_{2-8} alkynyl, a $(CH_2)_r$ - C_{3-10} carbocyclic residue substituted with 0-5 R^{10e} , and a $(CH_2)_r$ -5-10 membered heterocyclic system containing 1-4 heteroatoms selected from N, O, and S, substituted with 0-3 R^{10e} ;
- 30 R^{10b} , at each occurrence, is selected from C_{1-6} alkyl, C_{2-8} alkenyl, C_{2-8} alkynyl, a $(CH_2)_r$ - C_{3-6} carbocyclic residue substituted with 0-2 R^{10e} , and a $(CH_2)_r$ -5-6 membered

heterocyclic system containing 1-4 heteroatoms
selected from N, O, and S, substituted with 0-3 R^{10e};

5 R^{10c}, at each occurrence, is selected from C₁₋₆ alkyl, C₂₋₈
alkenyl, C₂₋₈ alkynyl, (CH₂)_rC₃₋₆ cycloalkyl, Cl, Br, I,
F, (CF₂)_rCF₃, NO₂, CN, (CH₂)_rNR^{10f}R^{10f}, (CH₂)_rOH,
(CH₂)_rOC₁₋₄ alkyl, (CH₂)_rSC₁₋₄ alkyl, (CH₂)_rC(O)OH,
(CH₂)_rC(O)R^{10b}, (CH₂)_rC(O)NR^{10f}R^{10f}, (CH₂)_rNR^{10f}C(O)R^{10a},
10 (CH₂)_rC(O)OC₁₋₄ alkyl, (CH₂)_rOC(O)R^{10b},
(CH₂)_rC(=NR^{10f})NR^{10f}R^{10f}, (CH₂)_rS(O)_pR^{10b},
(CH₂)_rNHC(=NR^{10f})NR^{10f}R^{10f}, (CH₂)_rS(O)₂NR^{10f}R^{10f},
(CH₂)_rNR^{10f}S(O)₂R^{10b}, and (CH₂)_rphenyl substituted with
0-3 R^{10e};

15 R^{10d}, at each occurrence, is selected from C₁₋₆ alkyl, C₂₋₆
alkenyl, C₂₋₆ alkynyl, a C₃₋₁₀ carbocyclic residue
substituted with 0-3 R^{10c}, and a 5-6 membered
heterocyclic system containing 1-4 heteroatoms
selected from the group consisting of N, O, and S
20 substituted with 0-3 R^{10c};

R^{10e}, at each occurrence, is selected from C₁₋₆ alkyl, C₂₋₈
alkenyl, C₂₋₈ alkynyl, (CH₂)_rC₃₋₆ cycloalkyl, Cl, F, Br,
I, CN, NO₂, (CF₂)_rCF₃, (CH₂)_rOC₁₋₅ alkyl, OH, SH,
25 (CH₂)_rSC₁₋₅ alkyl, (CH₂)_rNR^{10f}R^{10f}, and (CH₂)_rphenyl;

R^{10f}, at each occurrence, is selected from H, C₁₋₆ alkyl,
and C₃₋₆ cycloalkyl;

30 alternatively, R⁹ and R¹⁰ join to form C₃₋₇ cycloalkyl, 5-6-
membered cyclic ketal, or =O;

with the proviso that when R¹⁰ is -OH, R⁹ is not halogen,
cyano, or bonded to the carbon to which it is attached
35 through a heteroatom;

R¹¹, is selected from H, C₁₋₆ alkyl, C₂₋₈ alkenyl, C₂₋₈ alkynyl, (CH₂)_qOH, (CH₂)_qSH, (CH₂)_qOR^{11d}, (CH₂)_qSR^{11d}, (CH₂)_qNR^{11a}R^{11a'}, (CH₂)_rC(O)OH, (CH₂)_rC(O)R^{11b}, (CH₂)_rC(O)NR^{11a}R^{11a'}, (CH₂)_qNR^{11a}C(O)R^{11a},
 5 (CH₂)_qNR^{11a}C(O)NHR^{11a}, (CH₂)_rC(O)OR^{11b}, (CH₂)_qOC(O)R^{11b}, (CH₂)_qS(O)_pR^{11b}, (CH₂)_qS(O)₂NR^{11a}R^{11a'}, (CH₂)_qNR^{11a}S(O)₂R^{11b}, C₁₋₆ haloalkyl, a (CH₂)_r-C₃₋₁₀ carbocyclic residue substituted with 0-5 R^{11c}, and a (CH₂)_r-5-10 membered heterocyclic system containing 1-4
 10 heteroatoms selected from N, O, and S, substituted with 0-3 R^{11c};

R^{11a} and R^{11a'}, at each occurrence, are selected from H, C₁₋₆ alkyl, C₂₋₈ alkenyl, C₂₋₈ alkynyl, a (CH₂)_r-C₃₋₁₀ carbocyclic residue substituted with 0-5 R^{11e}, and a (CH₂)_r-5-10 membered heterocyclic system containing 1-4
 15 heteroatoms selected from N, O, and S, substituted with 0-3 R^{11e};

R^{11b}, at each occurrence, is selected from C₁₋₆ alkyl, C₂₋₈ alkenyl, C₂₋₈ alkynyl, a (CH₂)_r-C₃₋₆ carbocyclic residue substituted with 0-2 R^{11e}, and a (CH₂)_r-5-6 membered heterocyclic system containing 1-4 heteroatoms
 20 selected from N, O, and S, substituted with 0-3 R^{11e};

R^{11c}, at each occurrence, is selected from C₁₋₆ alkyl, C₂₋₈ alkenyl, C₂₋₈ alkynyl, (CH₂)_r-C₃₋₆ cycloalkyl, Cl, Br, I, F, (CF₂)_rCF₃, NO₂, CN, (CH₂)_rNR^{11f}R^{11f}, (CH₂)_rOH, (CH₂)_rOC₁₋₄ alkyl, (CH₂)_rSC₁₋₄ alkyl, (CH₂)_rC(O)OH, (CH₂)_rC(O)R^{11b}, (CH₂)_rC(O)NR^{11f}R^{11f}, (CH₂)_rNR^{11f}C(O)R^{11a}, (CH₂)_rC(O)OC₁₋₄ alkyl, (CH₂)_rOC(O)R^{11b}, (CH₂)_rC(=NR^{11f})NR^{11f}R^{11f}, (CH₂)_rNHC(=NR^{11f})NR^{11f}R^{11f}, (CH₂)_rS(O)_pR^{11b}, (CH₂)_rS(O)₂NR^{11f}R^{11f}, (CH₂)_rNR^{11f}S(O)₂R^{11b}, and (CH₂)_rphenyl substituted with
 30 0-3 R^{11e};
 35

R^{11d}, at each occurrence, is selected from C₁₋₆ alkyl substituted with 0-3 R^{11e}, C₂₋₆ alkenyl, C₂₋₆ alkynyl, and a C₃₋₁₀ carbocyclic residue substituted with 0-3 R^{11c};

5

R^{11e}, at each occurrence, is selected from C₁₋₆ alkyl, C₂₋₈ alkenyl, C₂₋₈ alkynyl, C₃₋₆ cycloalkyl, Cl, F, Br, I, CN, NO₂, (CF₂)_rCF₃, (CH₂)_rOC₁₋₅ alkyl, OH, SH, (CH₂)_rSC₁₋₅ alkyl, (CH₂)_rNR^{11f}R^{11f}, and (CH₂)_rphenyl;

10

R^{11f}, at each occurrence, is selected from H, C₁₋₆ alkyl, and C₃₋₆ cycloalkyl;

R¹² is selected from H, C₁₋₆ alkyl, (CH₂)_qOH, (CH₂)_rC₃₋₆ cycloalkyl, and (CH₂)_tphenyl substituted with 0-3 R^{12a};

15

R^{12a}, at each occurrence, is selected from C₁₋₆ alkyl, C₂₋₈ alkenyl, C₂₋₈ alkynyl, C₃₋₆ cycloalkyl, Cl, F, Br, I, CN, NO₂, (CF₂)_rCF₃, (CH₂)_rOC₁₋₅ alkyl, OH, SH, (CH₂)_rSC₁₋₅ alkyl, (CH₂)_rNR^{9f}R^{9f}, and (CH₂)_rphenyl;

20

alternatively, R¹¹ and R¹² join to form C₃₋₇ cycloalkyl;

R¹³, at each occurrence, is selected from C₁₋₆ alkyl, C₂₋₈ alkenyl, C₂₋₈ alkynyl, C₃₋₆ cycloalkyl, (CF₂)_wCF₃, (CH₂)NR^{13a}R^{13a'}, (CH₂)OH, (CH₂)OR^{13b}, (CH₂)SH, (CH₂)SR^{13b}, (CH₂)_wC(O)OH, (CH₂)_wC(O)R^{13b}, (CH₂)_wC(O)NR^{13a}R^{13a'}, (CH₂)NR^{13d}C(O)R^{13a}, (CH₂)_wC(O)OR^{13b}, (CH₂)OC(O)R^{13b}, (CH₂)_wS(O)_pR^{13b}, (CH₂)_wS(O)₂NR^{13a}R^{13a'}, (CH₂)NR^{13d}S(O)₂R^{13b}, and (CH₂)_w-phenyl substituted with 0-3 R^{13c};

25

30

R^{13a} and R^{13a'}, at each occurrence, are selected from H, C₁₋₆ alkyl, C₃₋₆ cycloalkyl, and phenyl substituted with 0-3 R^{13c};

35

R^{13b}, at each occurrence, is selected from C₁₋₆ alkyl, C₃₋₆

cycloalkyl, and phenyl substituted with 0-3 R^{13c};

R^{13c}, at each occurrence, is selected from C₁₋₆ alkyl, C₃₋₆ cycloalkyl, Cl, F, Br, I, CN, NO₂, (CF₂)_rCF₃, (CH₂)_rOC₁₋₅ alkyl, (CH₂)_rOH, (CH₂)_rSC₁₋₅ alkyl, and (CH₂)_rNR^{13d}R^{13d};

R^{13d}, at each occurrence, is selected from H, C₁₋₆ alkyl, and C₃₋₆ cycloalkyl;

10

R¹⁵, at each occurrence, is selected from C₁₋₈ alkyl, (CH₂)_rC₃₋₆ cycloalkyl, Cl, Br, I, F, NO₂, CN, (CHR')_rNR^{15a}R^{15a'}, (CHR')_rOH, (CHR')_rO(CHR')_rR^{15d}, (CHR')_rSH, (CHR')_rC(O)H, (CHR')_rS(CHR')_rR^{15d}, (CHR')_rC(O)OH, (CHR')_rC(O)(CHR')_rR^{15b}, (CHR')_rC(O)NR^{15a}R^{15a'}, (CHR')_rNR^{15f}C(O)(CHR')_rR^{15b}, (CHR')_rNR^{15f}C(O)NR^{15f}R^{15f}, (CHR')_rC(O)O(CHR')_rR^{15d}, (CHR')_rOC(O)(CHR')_rR^{15b}, (CHR')_rC(=NR^{15f})NR^{15a}R^{15a'}, (CHR')_rNHC(=NR^{15f})NR^{15f}R^{15f}, (CHR')_rS(O)_p(CHR')_rR^{15b}, (CHR')_rS(O)₂NR^{15a}R^{15a'}, (CHR')_rNR^{15f}S(O)₂(CHR')_rR^{15b}, C₁₋₆ haloalkyl, C₂₋₈ alkenyl substituted with 0-3 R', C₂₋₈ alkynyl substituted with 0-3 R', (CHR')_rphenyl substituted with 0-3 R^{15e}, and a (CH₂)_{r-5-10} membered heterocyclic system containing 1-4 heteroatoms selected from N, O, and S, substituted with 0-2 R^{15e};

25

R', at each occurrence, is selected from H, C₁₋₆ alkyl, C₂₋₈ alkenyl, C₂₋₈ alkynyl, (CH₂)_rC₃₋₆ cycloalkyl, and (CH₂)_rphenyl substituted with R^{15e};

30

R^{15a} and R^{15a'}, at each occurrence, are selected from H, C₁₋₆ alkyl, C₂₋₈ alkenyl, C₂₋₈ alkynyl, a (CH₂)_r-C₃₋₁₀ carbocyclic residue substituted with 0-5 R^{15e}, and a (CH₂)_{r-5-10} membered heterocyclic system containing 1-4 heteroatoms selected from N, O, and S, substituted with 0-2 R^{15e};

35

5 R^{15b}, at each occurrence, is selected from C₁₋₆ alkyl, C₂₋₈ alkenyl, C₂₋₈ alkynyl, a (CH₂)_r-C₃₋₆ carbocyclic residue substituted with 0-3 R^{15e}, and (CH₂)_r-5-6 membered heterocyclic system containing 1-4 heteroatoms selected from N, O, and S, substituted with 0-2 R^{15e};

10 R^{15d}, at each occurrence, is selected from C₂₋₈ alkenyl, C₂₋₈ alkynyl, C₁₋₆ alkyl substituted with 0-3 R^{15e}, a (CH₂)_r-C₃₋₁₀ carbocyclic residue substituted with 0-3 R^{15e}, and a (CH₂)_r-5-6 membered heterocyclic system containing 1-4 heteroatoms selected from N, O, and S, substituted with 0-3 R^{15e};

15 R^{15e}, at each occurrence, is selected from C₁₋₆ alkyl, C₂₋₈ alkenyl, C₂₋₈ alkynyl, (CH₂)_r-C₃₋₆ cycloalkyl, Cl, F, Br, I, CN, NO₂, (CF₂)_rCF₃, (CH₂)_rOC₁₋₅ alkyl, OH, SH, (CH₂)_rSC₁₋₅ alkyl, (CH₂)_rNR^{15f}R^{15f}, and (CH₂)_rphenyl;

20 R^{15f}, at each occurrence, is selected from H, C₁₋₆ alkyl, C₃₋₆ cycloalkyl, and phenyl;

25 R¹⁶, at each occurrence, is selected from C₁₋₈ alkyl, C₂₋₈ alkenyl, C₂₋₈ alkynyl, (CH₂)_r-C₃₋₆ cycloalkyl, Cl, Br, I, F, NO₂, CN, (CHR')_rNR^{16a}R^{16a'}, (CHR')_rOH, (CHR')_rO(CHR')_rR^{16d}, (CHR')_rSH, (CHR')_rC(O)H, (CHR')_rS(CHR')_rR^{16d}, (CHR')_rC(O)OH, (CHR')_rC(O)(CHR')_rR^{16b}, (CHR')_rC(O)NR^{16a}R^{16a'}, (CHR')_rNR^{16f}C(O)(CHR')_rR^{16b}, (CHR')_rC(O)O(CHR')_rR^{16d}, (CHR')_rOC(O)(CHR')_rR^{16b}, (CHR')_rC(=NR^{16f})NR^{16a}R^{16a'}, (CHR')_rNHC(=NR^{16f})NR^{16f}R^{16f}, (CHR')_rS(O)_p(CHR')_rR^{16b}, (CHR')_rS(O)₂NR^{16a}R^{16a'}, (CHR')_rNR^{16f}S(O)₂(CHR')_rR^{16b}, C₁₋₆ haloalkyl, C₂₋₈ alkenyl substituted with 0-3 R', C₂₋₈ alkynyl substituted with 0-3 R', and (CHR')_rphenyl substituted with 0-3 R^{16e};

35 R^{16a} and R^{16a'}, at each occurrence, are selected from H, C₁₋₆ alkyl, C₂₋₈ alkenyl, C₂₋₈ alkynyl, a (CH₂)_r-C₃₋₁₀

carbocyclic residue substituted with 0-5 R^{16e}, and a (CH₂)_r-5-10 membered heterocyclic system containing 1-4 heteroatoms selected from N, O, and S, substituted with 0-2 R^{16e};

5

R^{16b}, at each occurrence, is selected from C₁₋₆ alkyl, C₂₋₈ alkenyl, C₂₋₈ alkynyl, a (CH₂)_rC₃₋₆ carbocyclic residue substituted with 0-3 R^{16e}, and a (CH₂)_r-5-6 membered heterocyclic system containing 1-4 heteroatoms selected from N, O, and S, substituted with 0-2 R^{16e};

10

R^{16d}, at each occurrence, is selected from C₂₋₈ alkenyl, C₂₋₈ alkynyl, C₁₋₆ alkyl substituted with 0-3 R^{16e}, a (CH₂)_r-C₃₋₁₀ carbocyclic residue substituted with 0-3 R^{16e}, and a (CH₂)_r-5-6 membered heterocyclic system containing 1-4 heteroatoms selected from N, O, and S, substituted with 0-3 R^{16e};

15

R^{16e}, at each occurrence, is selected from C₁₋₆ alkyl, C₂₋₈ alkenyl, C₂₋₈ alkynyl, (CH₂)_rC₃₋₆ cycloalkyl, Cl, F, Br, I, CN, NO₂, (CF₂)_rCF₃, (CH₂)_rOC₁₋₅ alkyl, OH, SH, (CH₂)_rSC₁₋₅ alkyl, (CH₂)_rNR^{16f}R^{16f}, and (CH₂)_rphenyl;

20

R^{16f}, at each occurrence, is selected from H, C₁₋₅ alkyl, and C₃₋₆ cycloalkyl, and phenyl;

25

v is selected from 0, 1, and 2;

t is selected from 1 and 2;

30

w is selected from 0 and 1;

r is selected from 0, 1, 2, 3, 4, and 5;

35

q is selected from 1, 2, 3, 4, and 5; and

p is selected from 1, 2, and 3.

20. The compound of claim 19, wherein:

- 5 R⁴ is absent, taken with the nitrogen to which it is attached to form an N-oxide, or selected from C₁₋₈ alkyl, (CH₂)_rC₃₋₆ cycloalkyl, and (CH₂)_r-phenyl substituted with 0-3 R^{4c};
- 10 R^{4c}, at each occurrence, is selected from C₁₋₆ alkyl, C₂₋₈ alkenyl, C₂₋₈ alkynyl, C₃₋₆ cycloalkyl, Cl, F, Br, I, CN, NO₂, (CF₂)_rCF₃, (CH₂)_rOC₁₋₅ alkyl, (CH₂)_rOH, (CH₂)_rSC₁₋₅ alkyl, (CH₂)_rNR^{4a}R^{4a'}, and (CH₂)_rphenyl;
- 15 alternatively, R⁴ joins with R⁷, R⁹, or R¹¹ to form a 5, 6 or 7 membered piperidinium spirocycle or pyrrolidinium spirocycle substituted with 0-3 R^a;
- R¹ and R² are independently selected from H and C₁₋₄ alkyl;
- 20 R⁶, at each occurrence, is selected from C₁₋₄ alkyl, C₂₋₈ alkenyl, C₂₋₈ alkynyl, (CH₂)_rC₃₋₆ cycloalkyl, (CF₂)_rCF₃, CN, (CH₂)_rOH, (CH₂)_rOR^{6b}, (CH₂)_rC(O)R^{6b}, (CH₂)_rC(O)NR^{6a}R^{6a'}, (CH₂)_rNR^{6d}C(O)R^{6a}, and (CH₂)_tphenyl substituted with 0-3 R^{6c};
- 25 R^{6a} and R^{6a'}, at each occurrence, are selected from H, C₁₋₆ alkyl, C₃₋₆ cycloalkyl, and phenyl substituted with 0-3 R^{6c};
- 30 R^{6b}, at each occurrence, is selected from C₁₋₆ alkyl, C₃₋₆ cycloalkyl, and phenyl substituted with 0-3 R^{6c};
- 35 R^{6c}, at each occurrence, is selected from C₁₋₆ alkyl, C₃₋₆ cycloalkyl, Cl, F, Br, I, CN, NO₂, (CF₂)_rCF₃, (CH₂)_rOC₁₋₅ alkyl, (CH₂)_rOH, (CH₂)_rSC₁₋₅ alkyl, and (CH₂)_rNR^{6d}R^{6d};

- R^{6d}, at each occurrence, is selected from H, C₁₋₆ alkyl, and C₃₋₆ cycloalkyl;
- R⁷, is selected from H, C₁₋₃ alkyl, (CH₂)_rC₃₋₆ cycloalkyl, (CH₂)_qOH, (CH₂)_qOR^{7d}, (CH₂)_qNR^{7a}R^{7a'}, (CH₂)_rC(O)R^{7b}, (CH₂)_rC(O)NR^{7a}R^{7a'}, (CH₂)_qNR^{7a}C(O)R^{7a}, C₁₋₆ haloalkyl, (CH₂)_rphenyl with 0-2 R^{7c};
- R^{7a} and R^{7a'}, at each occurrence, are selected from H, C₁₋₆ alkyl, (CH₂)_rC₃₋₆ cycloalkyl, a (CH₂)_rphenyl substituted with 0-3 R^{7e};
- R^{7b}, at each occurrence, is selected from C₁₋₆ alkyl, C₂₋₈ alkenyl, C₂₋₈ alkynyl, (CH₂)_rC₃₋₆ cycloalkyl, (CH₂)_rphenyl substituted with 0-3 R^{7e};
- R^{7c}, at each occurrence, is selected from C₁₋₄ alkyl, C₂₋₈ alkenyl, C₂₋₈ alkynyl, (CH₂)_rC₃₋₆ cycloalkyl, Cl, Br, I, F, (CF₂)_rCF₃, NO₂, CN, (CH₂)_rNR^{7f}R^{7f}, (CH₂)_rOH, (CH₂)_rOC₁₋₄ alkyl, (CH₂)_rC(O)R^{7b}, (CH₂)_rC(O)NR^{7f}R^{7f}, (CH₂)_rNR^{7f}C(O)R^{7a}, (CH₂)_rS(O)_pR^{7b}, (CH₂)_rS(O)₂NR^{7f}R^{7f}, (CH₂)_rNR^{7f}S(O)₂R^{7b}, and (CH₂)_rphenyl substituted with 0-2 R^{7e};
- R^{7d}, at each occurrence, is selected from C₁₋₆ alkyl, (CH₂)_rC₃₋₆ cycloalkyl, (CH₂)_rphenyl substituted with 0-3 R^{7e};
- R^{7e}, at each occurrence, is selected from C₁₋₆ alkyl, C₂₋₈ alkenyl, C₂₋₈ alkynyl, C₃₋₆ cycloalkyl, Cl, F, Br, I, CN, NO₂, (CF₂)_rCF₃, (CH₂)_rOC₁₋₅ alkyl, OH, SH, (CH₂)_rSC₁₋₅ alkyl, (CH₂)_rNR^{7f}R^{7f}, and (CH₂)_rphenyl;
- R^{7f}, at each occurrence, is selected from H, C₁₋₅ alkyl, and C₃₋₆ cycloalkyl;
- R⁸ is H or joins with R⁷ to form C₃₋₇ cycloalkyl or =NR^{8b};

- 5 R^{11} , is selected from H, C_{1-6} alkyl, $(CH_2)_rC_{3-6}$ cycloalkyl, $(CH_2)_qOH$, $(CH_2)_qOR^{11d}$, $(CH_2)_qNR^{11a}R^{11a'}$, $(CH_2)_rC(O)R^{11b}$, $(CH_2)_rC(O)NR^{11a}R^{11a'}$, $(CH_2)_qNR^{11a}C(O)R^{11a}$, C_{1-6} haloalkyl, $(CH_2)_r$ phenyl with 0-2 R^{11c} , $(CH_2)_{r-5-10}$ membered heterocyclic system containing 1-4 heteroatoms selected from N, O, and S, substituted with 0-3 R^{15} ;
- 10 R^{11a} and $R^{11a'}$, at each occurrence, are selected from H, C_{1-6} alkyl, $(CH_2)_rC_{3-6}$ cycloalkyl, a $(CH_2)_r$ phenyl substituted with 0-3 R^{11e} ;
- 15 R^{11b} , at each occurrence, is selected from C_{1-6} alkyl, C_{2-8} alkenyl, C_{2-8} alkynyl, $(CH_2)_rC_{3-6}$ cycloalkyl, $(CH_2)_r$ phenyl substituted with 0-3 R^{11e} ;
- 20 R^{11c} , at each occurrence, is selected from C_{1-4} alkyl, C_{2-8} alkenyl, C_{2-8} alkynyl, $(CH_2)_rC_{3-6}$ cycloalkyl, Cl, Br, I, F, $(CF_2)_rCF_3$, NO_2 , CN, $(CH_2)_rNR^{11f}R^{11f}$, $(CH_2)_rOH$, $(CH_2)_rOC_{1-4}$ alkyl, $(CH_2)_rC(O)R^{11b}$, $(CH_2)_rC(O)NR^{11f}R^{11f}$, $(CH_2)_rNR^{11f}C(O)R^{11a}$, $(CH_2)_rS(O)_pR^{11b}$, $(CH_2)_rS(O)_2NR^{11f}R^{11f}$, $(CH_2)_rNR^{11f}S(O)_2R^{11b}$, and $(CH_2)_r$ phenyl substituted with 0-2 R^{11e} ;
- 25 R^{11d} , at each occurrence, is selected from C_{1-6} alkyl, $(CH_2)_rC_{3-6}$ cycloalkyl, $(CH_2)_r$ phenyl substituted with 0-3 R^{11e} ;
- 30 R^{11e} , at each occurrence, is selected from C_{1-6} alkyl, C_{2-8} alkenyl, C_{2-8} alkynyl, C_{3-6} cycloalkyl, Cl, F, Br, I, CN, NO_2 , $(CF_2)_rCF_3$, $(CH_2)_rOC_{1-5}$ alkyl, OH, SH, $(CH_2)_rSC_{1-5}$ alkyl, $(CH_2)_rNR^{11f}R^{11f}$, and $(CH_2)_r$ phenyl;
- 35 R^{11f} , at each occurrence, is selected from H, C_{1-5} alkyl and C_{3-6} cycloalkyl;
- R^{12} is H or joins with R^{11} to form C_{3-7} cycloalkyl;

R^{13} , at each occurrence, is selected from C_{1-4} alkyl, C_{3-6} cycloalkyl, $(CH_2)NR^{13a}R^{13a'}$, $(CH_2)OH$, $(CH_2)OR^{13b}$,
 $(CH_2)_wC(O)R^{13b}$, $(CH_2)_wC(O)NR^{13a}R^{13a'}$, $(CH_2)NR^{13d}C(O)R^{13a}$,
 5 $(CH_2)_wS(O)_2NR^{13a}R^{13a'}$, $(CH_2)NR^{13d}S(O)_2R^{13b}$, and
 $(CH_2)_w$ -phenyl substituted with 0-3 R^{13c} ;

R^{13a} and $R^{13a'}$, at each occurrence, are selected from H, C_{1-6} alkyl, C_{3-6} cycloalkyl, and phenyl substituted with 0-3
 10 R^{13c} ;

R^{13b} , at each occurrence, is selected from C_{1-6} alkyl, C_{3-6} cycloalkyl, and phenyl substituted with 0-3 R^{13c} ;

R^{13c} , at each occurrence, is selected from C_{1-6} alkyl, C_{3-6} cycloalkyl, Cl, F, Br, I, CN, NO_2 , $(CF_2)_rCF_3$, $(CH_2)_rOC_{1-5}$ alkyl, $(CH_2)_rOH$, and $(CH_2)_rNR^{13d}R^{13d}$;

R^{13d} , at each occurrence, is selected from H, C_{1-6} alkyl,
 20 and C_{3-6} cycloalkyl;

v is selected from 1 and 2;

q is selected from 1, 2, and 3; and
 25

r is selected from 0, 1, 2, and 3.

21. The compound of claim 20, wherein:

30 R^3 is selected from a $(CR^{3'H})_r$ -carbocyclic residue substituted with 0-5 R^{15} , wherein the carbocyclic residue is selected from phenyl, C_{3-6} cycloalkyl, naphthyl, and adamantyl; and a $(CR^{3'H})_r$ -heterocyclic system substituted with 0-3 R^{15} , wherein the
 35 heterocyclic system is selected from pyridinyl, thiophenyl, furanyl, indazolyl, benzothiazolyl, benzimidazolyl, benzothiophenyl, benzofuranyl,

benzoxazolyl, benzisoxazolyl, quinolinyl,
 isoquinolinyl, imidazolyl, indolyl, indolinyl,
 isoindolyl, isothiadiazolyl, isoxazolyl, piperidinyl,
 pyrrazolyl, 1,2,4-triazolyl, 1,2,3-triazolyl,
 5 tetrazolyl, thiadiazolyl, thiazolyl, oxazolyl,
 pyrazinyl, and pyrimidinyl; and

R⁵ is selected from (CR^{5'}H)_t-phenyl substituted with 0-5
 R¹⁶; and a (CR^{5'}H)_t-heterocyclic system substituted
 10 with 0-3 R¹⁶, wherein the heterocyclic system is
 selected from pyridinyl, thiophenyl, furanyl,
 indazolyl, benzothiazolyl, benzimidazolyl,
 benzothiophenyl, benzofuranyl, benzoxazolyl,
 15 benzisoxazolyl, quinolinyl, isoquinolinyl, imidazolyl,
 indolyl, isoindolyl, piperidinyl, pyrrazolyl, 1,2,4-
 triazolyl, 1,2,3-triazolyl, tetrazolyl, thiazolyl,
 oxazolyl, pyrazinyl, and pyrimidinyl.

22. The compound of claim 21, wherein the compound of
 20 formula (I) is:

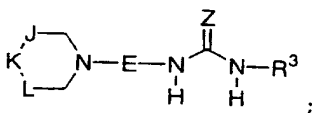

R¹⁶, at each occurrence, is selected from C₁₋₈ alkyl,
 (CH₂)_rC₃₋₆ cycloalkyl, CF₃, Cl, Br, I, F,
 25 (CH₂)_rNR^{16a}R^{16a'}, NO₂, CN, OH, (CH₂)_rOR^{16d},
 (CH₂)_rC(O)R^{16b}, (CH₂)_rC(O)NR^{16a}R^{16a'}, (CH₂)_rNR^{16f}C(O)R^{16b},
 (CH₂)_rS(O)_pR^{16b}, (CH₂)_rS(O)₂NR^{16a}R^{16a'},
 (CH₂)_rNR^{16f}S(O)₂R^{16b}, and (CH₂)_rphenyl substituted with
 0-3 R^{16e};

30 R^{16a} and R^{16a'}, at each occurrence, are selected from H, C₁₋₆
 alkyl, C₃₋₆ cycloalkyl, and (CH₂)_rphenyl substituted
 with 0-3 R^{16e};

R^{16b}, at each occurrence, is selected from H, C₁₋₆ alkyl, C₃₋₆ cycloalkyl, and (CH₂)_rphenyl substituted with 0-3 R^{16e};

5 R^{16d}, at each occurrence, is selected from C₁₋₆ alkyl and phenyl;

R^{16e}, at each occurrence, is selected from C₁₋₆ alkyl, Cl, F, Br, I, CN, NO₂, (CF₂)_rCF₃, OH, and (CH₂)_rOC₁₋₅ alkyl;
10 and

R^{16f}, at each occurrence, is selected from H, and C₁₋₅ alkyl.

15 23. The compound of claim of claim 21, wherein the compound of formula (I) is:

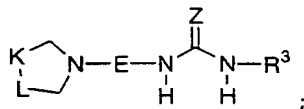

20 R¹⁶, at each occurrence, is selected from C₁₋₈ alkyl, (CH₂)_rC₃₋₆ cycloalkyl, CF₃, Cl, Br, I, F, (CH₂)_rNR^{16a}R^{16a'}, NO₂, CN, OH, (CH₂)_rOR^{16d}, (CH₂)_rC(O)R^{16b}, (CH₂)_rC(O)NR^{16a}R^{16a'}, (CH₂)_rNR^{16f}C(O)R^{16b}, (CH₂)_rS(O)_pR^{16b}, (CH₂)_rS(O)₂NR^{16a}R^{16a'},
25 (CH₂)_rNR^{16f}S(O)₂R^{16b}, and (CH₂)_rphenyl substituted with 0-3 R^{16e};

R^{16a} and R^{16a'}, at each occurrence, are selected from H, C₁₋₆ alkyl, C₃₋₆ cycloalkyl, and (CH₂)_rphenyl substituted
30 with 0-3 R^{16e};

R^{16b}, at each occurrence, is selected from H, C₁₋₆ alkyl, C₃₋₆ cycloalkyl, and (CH₂)_rphenyl substituted with 0-3 R^{16e};

35

R^{16d}, at each occurrence, is selected from C₁₋₆ alkyl and phenyl;

5 R^{16e}, at each occurrence, is selected from C₁₋₆ alkyl, Cl, F, Br, I, CN, NO₂, (CF₂)_rCF₃, OH, and (CH₂)_rOC₁₋₅ alkyl; and

10 R^{16f}, at each occurrence, is selected from H, and C₁₋₅ alkyl.

24. The compound of claim 22, wherein:

R⁵ is CH₂phenyl substituted with 0-3 R¹⁶;

15 E is -CH₂-(CR⁹R¹⁰)-(CR¹¹R¹²);

20 R⁹, is selected from H, C₁₋₆ alkyl, (CH₂)_rC₃₋₆ cycloalkyl, F, Cl, CN, (CH₂)_rOH, (CH₂)_rOR^{9d}, (CH₂)_rNR^{9a}R^{9a'}, (CH₂)_rOC(O)NHR^{9a}, (CH₂)_rphenyl substituted with 0-5 R^{9e}, and a heterocyclic system substituted with 0-2 R^{9e}, wherein the heterocyclic system is selected from pyridyl, thiophenyl, furanyl, oxazolyl, and thiazolyl;

25 R^{9a} and R^{9a'}, at each occurrence, are selected from H, C₁₋₆ alkyl, C₃₋₆ cycloalkyl, and (CH₂)_rphenyl substituted with 0-3 R^{9e};

30 R^{9d}, at each occurrence, is selected from C₁₋₆ alkyl and phenyl;

R^{9e}, at each occurrence, is selected from C₁₋₆ alkyl, Cl, F, Br, I, CN, NO₂, (CF₂)_rCF₃, OH, and (CH₂)_rOC₁₋₅ alkyl;

35 R¹⁰ is selected from H, C₁₋₅ alkyl, OH, and CH₂OH;

alternatively, R⁹ and R¹⁰ join to form C₃₋₇ cycloalkyl, 5-6-membered cyclic ketal or =O;

with the proviso that when R¹⁰ is -OH, R⁹ is not halogen, cyano, or bonded to the carbon to which it is attached through a heteroatom;

5
R¹¹ is selected from H, C₁₋₈ alkyl, (CH₂)_rphenyl substituted with 0-5 R^{11e}, and a (CH₂)_r-heterocyclic system substituted with 0-2 R^{11e}, wherein the heterocyclic system is selected from pyridinyl, thiophenyl,
10 furanyl, indazolyl, benzothiazolyl, benzimidazolyl, benzothiophenyl, benzofuranyl, benzoxazolyl, benzisoxazolyl, quinolinyl, isoquinolinyl, imidazolyl, indolyl, isoindolyl, piperidinyl, pyrrolazolyl, 1,2,4-triazolyl, 1,2,3-triazolyl, tetrazolyl, thiazolyl,
15 oxazolyl, pyrazinyl, and pyrimidinyl; and

R^{11e}, at each occurrence, is selected from C₁₋₆ alkyl, Cl, F, Br, I, CN, NO₂, (CF₂)_rCF₃, OH, and (CH₂)_rOC₁₋₅ alkyl;

20 R¹² is H;

alternatively, R¹¹ and R¹² join to form C₃₋₇ cycloalkyl; and

r is selected from 0, 1, and 2.

25

25. The compound of claim 23, wherein:

R⁵ is CH₂phenyl substituted with 0-3 R¹⁶;

30 E is -CH₂-(CR⁹R¹⁰)-(CR¹¹R¹²);

R⁹, is selected from H, C₁₋₆ alkyl, (CH₂)_rC₃₋₆ cycloalkyl, F, Cl, CN, (CH₂)_rOH, (CH₂)_rOR^{9d}, (CH₂)_rNR^{9a}R^{9a'}, (CH₂)_rOC(O)NHR^{9a}, (CH₂)_rphenyl substituted with 0-5 R^{9e},
35 and a heterocyclic system substituted with 0-2 R^{9e}, wherein the heterocyclic system is selected from pyridyl, thiophenyl, furanyl, oxazolyl, and thiazolyl;

R^{9a} and R^{9a'}, at each occurrence, are selected from H, C₁₋₆ alkyl, C₃₋₆ cycloalkyl, and (CH₂)_rphenyl substituted with 0-3 R^{9e};

5

R^{9d}, at each occurrence, is selected from C₁₋₆ alkyl and phenyl;

R^{9e}, at each occurrence, is selected from C₁₋₆ alkyl, Cl, F, Br, I, CN, NO₂, (CF₂)_rCF₃, OH, and (CH₂)_rOC₁₋₅ alkyl;

10

R¹⁰ is selected from H, C₁₋₈ alkyl, OH, and CH₂OH;

alternatively, R⁹ and R¹⁰ join to form C₃₋₇ cycloalkyl, 5-6-membered cyclic ketal or =O;

15

with the proviso that when R¹⁰ is -OH, R⁹ is not halogen, cyano, or bonded to the carbon to which it is attached through a heteroatom;

20

R¹¹ is selected from H, C₁₋₈ alkyl, (CH₂)_rphenyl substituted with 0-5 R^{11e}, and a (CH₂)_r-heterocyclic system substituted with 0-2 R^{11e}, wherein the heterocyclic system is selected from pyridinyl, thiophenyl, furanyl, indazolyl, benzothiazolyl, benzimidazolyl, benzothiophenyl, benzofuranyl, benzoxazolyl, benzisoxazolyl, quinolinyl, isoquinolinyl, imidazolyl, indolyl, isoindolyl, piperidinyl, pyrrazolyl, 1,2,4-triazolyl, 1,2,3-triazolyl, tetrazolyl, thiazolyl, oxazolyl, pyrazinyl, and pyrimidinyl; and

25

30

R^{11e}, at each occurrence, is selected from C₁₋₆ alkyl, Cl, F, Br, I, CN, NO₂, (CF₂)_rCF₃, OH, and (CH₂)_rOC₁₋₅ alkyl;

R¹² is H;

35

alternatively, R¹¹ and R¹² join to form C₃₋₇ cycloalkyl; and

r is selected from 0, 1, and 2.

26. The compound of claim 24, wherein:

5

J is selected from CH₂ and CHR⁵;

K is selected from CH₂ and CHR⁵;

10 L is selected from CH₂ and CHR⁵;

R³ is a C₃₋₁₀ carbocyclic residue substituted with 0-3 R¹⁵,
wherein the carbocyclic residue is selected from
cyclopropyl, cyclopentyl, cyclohexyl, phenyl, naphthyl
15 and adamantyl, and a (CR^{3'}H)_r-heterocyclic system
substituted with 0-3 R¹⁵, wherein the heterocyclic
system is selected from pyridinyl, thiophenyl,
furanlyl, indazolyl, benzothiazolyl, benzimidazolyl,
benzothiophenyl, benzofuranlyl, benzoxazolyl,
20 benzisoxazolyl, quinolinyl, isoquinolinyl, imidazolyl,
indolyl, indolinyl, isoindolyl, isothiadiazolyl,
isoxazolyl, piperidinyl, pyrrazolyl, 1,2,4-triazolyl,
1,2,3-triazolyl, tetrazolyl, thiadiazolyl, thiazolyl,
oxazolyl, pyrazinyl, and pyrimidinyl; and

25

R¹⁵, at each occurrence, is selected from C₁₋₈ alkyl,
(CH₂)_rC₃₋₆ cycloalkyl, CF₃, Cl, Br, I, F,
(CH₂)_rNR^{15a}R^{15a'}, NO₂, CN, OH, (CH₂)_rOR^{15d},
(CH₂)_rC(O)R^{15b}, (CH₂)_rC(O)NR^{15a}R^{15a'}, (CH₂)_rNR^{15f}C(O)R^{15b},
30 (CH₂)_rS(O)_pR^{15b}, (CH₂)_rS(O)₂NR^{15a}R^{15a'},
(CH₂)_rNR^{15f}S(O)₂R^{15b}, (CH₂)_rphenyl substituted with 0-3
R^{15e}, and a (CH₂)_r-5-6 membered heterocyclic system
containing 1-4 heteroatoms selected from N, O, and S,
substituted with 0-2 R^{15e};

35

R^{15a} and R^{15a'}, at each occurrence, are selected from H, C₁₋₆ alkyl, C₃₋₆ cycloalkyl, and (CH₂)_rphenyl substituted with 0-3 R^{15e};

5 R^{15b}, at each occurrence, is selected from H, C₁₋₆ alkyl, C₃₋₆ cycloalkyl, and (CH₂)_rphenyl substituted with 0-3 R^{15e};

10 R^{15d}, at each occurrence, is selected from C₁₋₆ alkyl and phenyl;

R^{15e}, at each occurrence, is selected from C₁₋₆ alkyl, Cl, F, Br, I, CN, NO₂, (CF₂)_rCF₃, OH, and (CH₂)_rOC₁₋₅ alkyl; and

15 R^{15f}, at each occurrence, is selected from H, and C₁₋₅ alkyl.

27. The compound of claim 25, wherein:

20 K is selected from CH₂ and CHR⁵;

L is selected from CH₂ and CHR⁵;

25 R³ is a C₃₋₁₀ carbocyclic residue substituted with 0-3 R¹⁵, wherein the carbocyclic residue is selected from cyclopropyl, cyclopentyl, cyclohexyl, phenyl, naphthyl and adamantyl, and a (CR^{3'}H)_r-heterocyclic system substituted with 0-3 R¹⁵, wherein the heterocyclic
30 system is selected from pyridinyl, thiophenyl, furanyl, indazolyl, benzothiazolyl, benzimidazolyl, benzothiophenyl, benzofuranyl, benzoxazolyl, benzisoxazolyl, quinolinyl, isoquinolinyl, imidazolyl, indolyl, indolinyl, isoindolyl, isothiadiazolyl,
35 isoxazolyl, piperidinyl, pyrazolyl, 1,2,4-triazolyl, 1,2,3-triazolyl, tetrazolyl, thiadiazolyl, thiazolyl, oxazolyl, pyrazinyl, and pyrimidinyl; and

R^{15} , at each occurrence, is selected from C_{1-8} alkyl,
 $(CH_2)_r C_{3-6}$ cycloalkyl, CF_3 , Cl, Br, I, F,
 $(CH_2)_r NR^{15a} R^{15a'}$, NO_2 , CN, OH, $(CH_2)_r OR^{15d}$,
 5 $(CH_2)_r C(O)R^{15b}$, $(CH_2)_r C(O)NR^{15a} R^{15a'}$, $(CH_2)_r NR^{15f} C(O)R^{15b}$,
 $(CH_2)_r S(O)_p R^{15b}$, $(CH_2)_r S(O)_2 NR^{15a} R^{15a'}$,
 $(CH_2)_r NR^{15f} S(O)_2 R^{15b}$, $(CH_2)_r$ phenyl substituted with 0-3
 R^{15e} , and a $(CH_2)_r$ -5-6 membered heterocyclic system
 10 containing 1-4 heteroatoms selected from N, O, and S,
 substituted with 0-2 R^{15e} ;

R^{15a} and $R^{15a'}$, at each occurrence, are selected from H, C_{1-6}
 alkyl, C_{3-6} cycloalkyl, and $(CH_2)_r$ phenyl substituted
 with 0-3 R^{15e} ;

R^{15b} , at each occurrence, is selected from H, C_{1-6} alkyl,
 C_{3-6} cycloalkyl, and $(CH_2)_r$ phenyl substituted with 0-3
 R^{15e} ;

R^{15d} , at each occurrence, is selected from C_{1-6} alkyl and
 phenyl;

R^{15e} , at each occurrence, is selected from C_{1-6} alkyl, Cl,
 F, Br, I, CN, NO_2 , $(CF_2)_r CF_3$, OH, and $(CH_2)_r OC_{1-5}$ alkyl;
 25 and

R^{15f} , at each occurrence, is selected from H, and C_{1-5}
 alkyl.

30 28. The compound of claim 1 and pharmaceutically
 acceptable salt forms thereof, wherein the compound of
 formula (I) is selected from:

N'' -cyano- N -(3-methoxyphenyl)- N' -[3-[4-(phenylmethyl)-1-
 35 piperidinyl]propyl]guanidine,

N'' -cyano- N -(3-methoxyphenyl)- N' -[3-[4-(4-
 fluorophenylmethyl)-1-piperidinyl]propyl]guanidine.

- N*-(3-acetylphenyl)-*N*"-cyano-*N*'-[3-[4-(4-fluorophenylmethyl)-1-piperidinyl]propyl]guanidine,
- 5 *N*-(3-acetylphenyl)-*N*"-cyano-*N*'-[3-[(3*S*)-3-(4-fluorobenzyl)piperidinyl]propyl]guanidine,
- N*"-cyano-*N*-(3,5-diacetylphenyl)-*N*'-[3-[(3*S*)-3-(4-fluorobenzyl)piperidinyl]propyl]guanidine,
- 10 *N*"-cyano-*N*-(3-[(3*S*)-3-(4-fluorobenzyl)piperidinyl]propyl)-*N*'-[3-(1-methyl-1*H*-tetrazol-5-yl)phenyl]guanidine,
- N*"-cyano-*N*-(2,4-dimethoxyphenyl)-*N*'-[3-[(3*S*)-3-(4-fluorobenzyl)piperidinyl]propyl]guanidine,
- 15 *N*-(5-acetyl-2-methoxyphenyl)-*N*"-cyano-*N*'-[3-[(3*S*)-3-(4-fluorobenzyl)piperidinyl]propyl]guanidine,
- N*-(3-acetylphenyl)-*N*"-cyano-*N*'-[(3*R*, 4*R*)-5-[4-(4-fluorobenzyl)piperidinyl]-4-hydroxy-1-methyl-3-pentyl]guanidine,
- 20 *N*"-cyano-*N*-(3-[(3*S*)-3-(4-fluorobenzyl)piperidinyl]-2-(2*E*)-propenyl)-*N*'-[3-(1-methyl-1*H*-tetrazol-5-yl)phenyl]guanidine,
- 25 2-[(3-acetylanilino)({3-[(4-(4-fluorobenzyl)piperidinyl]propyl)amino)methylene]malononitrile,
- 30 2-[(3-acetylanilino)({3-[(3*S*)-3-(4-fluorobenzyl)piperidinyl]propyl)amino)methylene]malononitrile,
- 35 2-[(3-(1-methyl-1*H*-tetrazol-5-yl)anilino)({3-[(3*S*)-3-(4-fluorobenzyl)piperidinyl]propyl)amino)methylene]malononitrile,

N-[(*E*)-(3-acetylanilino)((3-[(3*S*)-3-(4-fluorobenzyl)piperidinyl]propyl)amino)methylidene]urea

5 *N*-[(*E*)-(3,5-diacetylanilino)((3-[(3*S*)-3-(4-fluorobenzyl)piperidinyl]propyl)amino)methylidene]urea

10 *N*-[(*E*)-[3-(1-methyl-1*H*-tetrazol-5-yl)anilino)((3-[(3*S*)-3-(4-fluorobenzyl)piperidinyl]propyl)amino)methylidene]urea

15 Methyl (*E*)-(3,5-diacetylanilino)((3-[(3*S*)-3-(4-fluorobenzyl)piperidinyl]propyl)amino)methylidene carbamate,

20 1-(3-[[(*E*)-1-((3-[4-(4-fluorobenzyl)piperidinyl]propyl)amino)-2-nitroethenyl]amino)phenyl)ethanone, and

1-(3-[[(*E*)-1-((3-[(3*S*)-3-(4-fluorobenzyl)piperidinyl]propyl)amino)-2-nitroethenyl]amino)phenyl)ethanone.

25

29. A compound of formula (I):

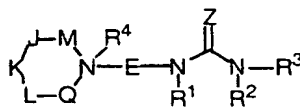

30 or stereoisomers or pharmaceutically acceptable salts thereof, wherein:

M is absent or selected from CH₂, CHR⁵, CHR¹³, CR¹³R¹³, and CR⁵R¹³;

35

Q is selected from CH₂, CHR⁵, CHR¹³, CR¹³R¹³, and CR⁵R¹³;

J, K, and L are independently selected from CH₂, CHR⁵, CHR⁶, CR⁶R⁶ and CR⁵R⁶;

5 with the provisos:

1) at least one of M, J, K, L, or Q contains an R⁵;
and

10 2) when M is absent, J is selected from CH₂, CHR⁵, CHR¹³, and CR⁵R¹³;

Z is selected from NR^{1a}, CHCN, CHNO₂, and C(CN)₂;

15 R^{1a} is selected from H, C₁₋₆ alkyl, C₃₋₆ cycloalkyl, CONR^{1b}R^{1b}, OR^{1b}, CN, NO₂, and (CH₂)_wPhenyl;

R^{1b} is independently selected from H, C₁₋₃ alkyl, C₃₋₆ cycloalkyl, and phenyl;

20

E is selected from:

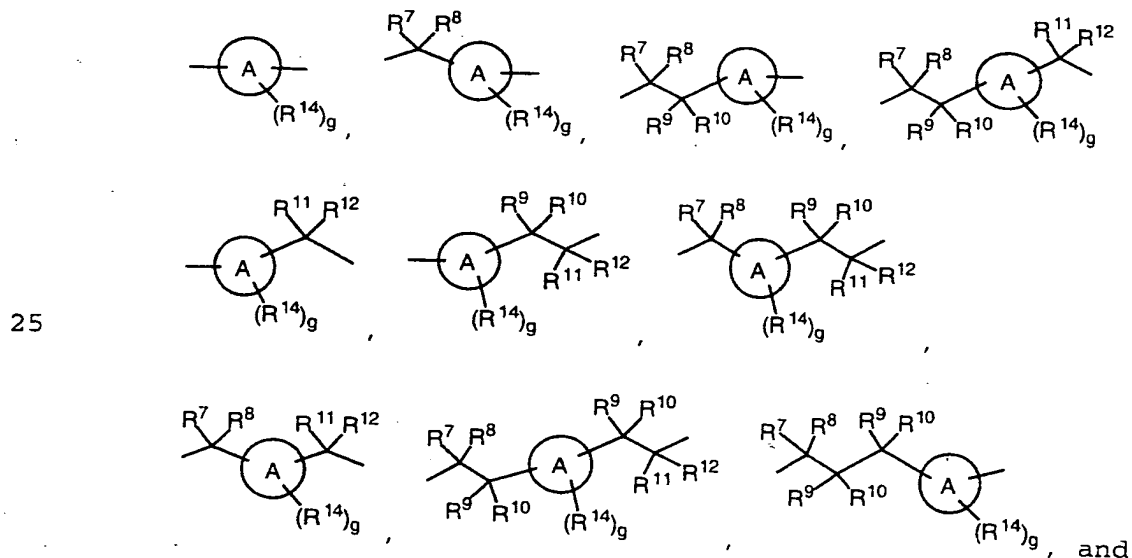

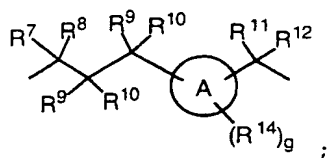

ring A is a C₃₋₆ carbocyclic residue;

- 5 R¹ and R² are independently selected from H, C₁₋₆ alkyl, C₂₋₈ alkenyl, C₂₋₈ alkynyl, (CH₂)_rC₃₋₆ cycloalkyl, and a (CH₂)_r-C₃₋₁₀ carbocyclic residue substituted with 0-5 R^a;
- 10 R^a, at each occurrence, is selected from C₁₋₆ alkyl, C₂₋₈ alkenyl, C₂₋₈ alkynyl, (CH₂)_rC₃₋₆ cycloalkyl, Cl, Br, I, F, (CF₂)_rCF₃, NO₂, CN, (CH₂)_rNR^bR^b, (CH₂)_rOH, (CH₂)_rOR^c, (CH₂)_rSH, (CH₂)_rSR^c, (CH₂)_rC(O)R^b, (CH₂)_rC(O)NR^bR^b, (CH₂)_rNR^bC(O)R^b, (CH₂)_rC(O)OR^b, (CH₂)_rOC(O)R^c, (CH₂)_rCH(=NR^b)NR^bR^b, (CH₂)_rNHC(=NR^b)NR^bR^b, (CH₂)_rS(O)_pR^c, (CH₂)_rS(O)₂NR^bR^b, (CH₂)_rNR^bS(O)₂R^c, and (CH₂)_rphenyl;
- 15 R^b, at each occurrence, is selected from H, C₁₋₆ alkyl, C₃₋₆ cycloalkyl, and phenyl;
- 20 R^c, at each occurrence, is selected from C₁₋₆ alkyl, C₃₋₆ cycloalkyl, and phenyl;
- 25 alternatively, R² and R³ join to form a 5, 6, or 7-membered ring substituted with 0-3 R^a;
- 30 R³ is selected from a (CR^{3'}R^{3''})_r-C₃₋₁₀ carbocyclic residue substituted with 0-5 R¹⁵ and a (CR^{3'}R^{3''})_r-5-10 membered heterocyclic system containing 1-4 heteroatoms selected from N, O, and S, substituted with 0-3 R¹⁵;
- R^{3'} and R^{3''}, at each occurrence, are selected from H, C₁₋₆ alkyl, (CH₂)_rC₃₋₆ cycloalkyl, and phenyl;

5 R^4 is absent, taken with the nitrogen to which it is attached to form an N-oxide, or selected from C_{1-6} alkyl, C_{2-8} alkenyl, C_{2-8} alkynyl, $(CH_2)_rC_{3-6}$ cycloalkyl, $(CH_2)_qC(O)R^{4b}$, $(CH_2)_qC(O)NR^{4a}R^{4a'}$, $(CH_2)_qC(O)OR^{4b}$, and a $(CH_2)_r-C_{3-10}$ carbocyclic residue substituted with 0-3 R^{4c} ;

10 R^{4a} and $R^{4a'}$, at each occurrence, are selected from H, C_{1-6} alkyl, $(CH_2)_rC_{3-6}$ cycloalkyl, and phenyl;

15 R^{4b} , at each occurrence, is selected from C_{1-6} alkyl, C_{2-8} alkenyl, $(CH_2)_rC_{3-6}$ cycloalkyl, C_{2-8} alkynyl, and phenyl;

20 R^{4c} , at each occurrence, is selected from C_{1-6} alkyl, C_{2-8} alkenyl, C_{2-8} alkynyl, C_{3-6} cycloalkyl, Cl, F, Br, I, CN, NO_2 , $(CF_2)_rCF_3$, $(CH_2)_rOC_{1-5}$ alkyl, $(CH_2)_rOH$, $(CH_2)_rSC_{1-5}$ alkyl, $(CH_2)_rNR^{4a}R^{4a'}$, and $(CH_2)_rphenyl$;

25 alternatively, R^4 joins with R^7 , R^9 , or R^{11} to form a 5, 6 or 7 membered piperidinium spirocycle or pyrrolidinium spirocycle substituted with 0-3 R^a ;

30 R^5 is selected from a $(CR^{5'}R^{5''})_t-C_{3-10}$ carbocyclic residue substituted with 0-5 R^{16} and a $(CR^{5'}R^{5''})_t-5-10$ membered heterocyclic system containing 1-4 heteroatoms selected from N, O, and S, substituted with 0-3 R^{16} ;

35 $R^{5'}$ and $R^{5''}$, at each occurrence, are selected from H, C_{1-6} alkyl, $(CH_2)_rC_{3-6}$ cycloalkyl, and phenyl;

40 R^6 , at each occurrence, is selected from C_{1-6} alkyl, C_{2-8} alkenyl, C_{2-8} alkynyl, $(CH_2)_rC_{3-6}$ cycloalkyl, $(CF_2)_rCF_3$, CN, $(CH_2)_rNR^{6a}R^{6a'}$, $(CH_2)_rOH$, $(CH_2)_rOR^{6b}$, $(CH_2)_rSH$, $(CH_2)_rSR^{6b}$, $(CH_2)_rC(O)OH$, $(CH_2)_rC(O)R^{6b}$, $(CH_2)_rC(O)NR^{6a}R^{6a'}$, $(CH_2)_rNR^{6d}C(O)R^{6a}$, $(CH_2)_rC(O)OR^{6b}$, $(CH_2)_rOC(O)R^{6b}$, $(CH_2)_rS(O)_pR^{6b}$, $(CH_2)_rS(O)_2NR^{6a}R^{6a'}$,

$(\text{CH}_2)_r\text{NR}^{6d}\text{S}(\text{O})_2\text{R}^{6b}$, and $(\text{CH}_2)_t$ phenyl substituted with 0-3 R^{6c} ;

5 R^{6a} and $\text{R}^{6a'}$, at each occurrence, are selected from H, C_{1-6} alkyl, C_{3-6} cycloalkyl, and phenyl substituted with 0-3 R^{6c} ;

R^{6b} , at each occurrence, is selected from C_{1-6} alkyl, C_{3-6} cycloalkyl, and phenyl substituted with 0-3 R^{6c} ;

10 R^{6c} , at each occurrence, is selected from C_{1-6} alkyl, C_{3-6} cycloalkyl, Cl, F, Br, I, CN, NO_2 , $(\text{CF}_2)_r\text{CF}_3$, $(\text{CH}_2)_r\text{OC}_{1-5}$ alkyl, $(\text{CH}_2)_r\text{OH}$, $(\text{CH}_2)_r\text{SC}_{1-5}$ alkyl, and $(\text{CH}_2)_r\text{NR}^{6d}\text{R}^{6d}$;

15 R^{6d} , at each occurrence, is selected from H, C_{1-6} alkyl, and C_{3-6} cycloalkyl;

R^7 , is selected from H, C_{1-6} alkyl, C_{2-8} alkenyl, C_{2-8} alkynyl, $(\text{CH}_2)_q\text{OH}$, $(\text{CH}_2)_q\text{SH}$, $(\text{CH}_2)_q\text{OR}^{7d}$, $(\text{CH}_2)_q\text{SR}^{7d}$, $(\text{CH}_2)_q\text{NR}^{7a}\text{R}^{7a'}$, $(\text{CH}_2)_r\text{C}(\text{O})\text{OH}$, $(\text{CH}_2)_r\text{C}(\text{O})\text{R}^{7b}$, $(\text{CH}_2)_r\text{C}(\text{O})\text{NR}^{7a}\text{R}^{7a'}$, $(\text{CH}_2)_q\text{NR}^{7a}\text{C}(\text{O})\text{R}^{7a}$, $(\text{CH}_2)_q\text{NR}^{7a}\text{C}(\text{O})\text{H}$, $(\text{CH}_2)_r\text{C}(\text{O})\text{OR}^{7b}$, $(\text{CH}_2)_q\text{OC}(\text{O})\text{R}^{7b}$, $(\text{CH}_2)_q\text{S}(\text{O})_p\text{R}^{7b}$, $(\text{CH}_2)_q\text{S}(\text{O})_2\text{NR}^{7a}\text{R}^{7a'}$, $(\text{CH}_2)_q\text{NR}^{7a}\text{S}(\text{O})_2\text{R}^{7b}$, C_{1-6} haloalkyl, a $(\text{CH}_2)_r\text{-C}_{3-10}$ carbocyclic residue substituted with 0-3 R^{7c} , and a $(\text{CH}_2)_r\text{-5-10}$ membered heterocyclic system containing 1-4 heteroatoms selected from N, O, and S, substituted with 0-2 R^{7c} ;

20 R^{7a} and $\text{R}^{7a'}$, at each occurrence, are selected from H, C_{1-6} alkyl, C_{2-8} alkenyl, C_{2-8} alkynyl, $(\text{CH}_2)_r\text{C}_{3-6}$ cycloalkyl, a $(\text{CH}_2)_r\text{-C}_{3-10}$ carbocyclic residue substituted with 0-5 R^{7e} , and a $(\text{CH}_2)_r\text{-5-10}$ membered heterocyclic system containing 1-4 heteroatoms selected from N, O, and S, substituted with 0-3 R^{7e} ;

35 R^{7b} , at each occurrence, is selected from C_{1-6} alkyl, C_{2-8} alkenyl, C_{2-8} alkynyl, a $(\text{CH}_2)_r\text{-C}_{3-6}$ carbocyclic residue

substituted with 0-2 R^{7e}, and a (CH₂)_r-5-6 membered heterocyclic system containing 1-4 heteroatoms selected from N, O, and S, substituted with 0-3 R^{7e};

- 5 R^{7c}, at each occurrence, is selected from C₁₋₆ alkyl, C₂₋₈ alkenyl, C₂₋₈ alkynyl, (CH₂)_rC₃₋₆ cycloalkyl, Cl, Br, I, F, (CF₂)_rCF₃, NO₂, CN, (CH₂)_rNR^{7f}R^{7f}, (CH₂)_rOH, (CH₂)_rOC₁₋₄ alkyl, (CH₂)_rSC₁₋₄ alkyl, (CH₂)_rC(O)OH, (CH₂)_rC(O)R^{7b}, (CH₂)_rC(O)NR^{7f}R^{7f}, (CH₂)_rNR^{7f}C(O)R^{7a},
 10 (CH₂)_rC(O)OC₁₋₄ alkyl, (CH₂)_rOC(O)R^{7b}, (CH₂)_rC(=NR^{7f})NR^{7f}R^{7f}, (CH₂)_rS(O)_pR^{7b}, (CH₂)_rNHC(=NR^{7f})NR^{7f}R^{7f}, (CH₂)_rS(O)₂NR^{7f}R^{7f}, (CH₂)_rNR^{7f}S(O)₂R^{7b}, and (CH₂)_rphenyl substituted with 0-3 R^{7e};
- 15 R^{7d}, at each occurrence, is selected from C₁₋₆ alkyl substituted with 0-3 R^{7e}, alkenyl, alkynyl, and a C₃₋₁₀ carbocyclic residue substituted with 0-3 R^{7c};
- 20 R^{7e}, at each occurrence, is selected from C₁₋₆ alkyl, C₂₋₈ alkenyl, C₂₋₈ alkynyl, C₃₋₆ cycloalkyl, Cl, F, Br, I, CN, NO₂, (CF₂)_rCF₃, (CH₂)_rOC₁₋₅ alkyl, OH, SH, (CH₂)_rSC₁₋₅ alkyl, (CH₂)_rNR^{7f}R^{7f}, and (CH₂)_rphenyl;
- 25 R^{7f}, at each occurrence, is selected from H, C₁₋₆ alkyl, and C₃₋₆ cycloalkyl;
- R⁸ is selected from H, C₁₋₆ alkyl, C₃₋₆ cycloalkyl, and (CH₂)_tphenyl substituted with 0-3 R^{8a};
- 30 R^{8a}, at each occurrence, is selected from C₁₋₆ alkyl, C₂₋₈ alkenyl, C₂₋₈ alkynyl, C₃₋₆ cycloalkyl, Cl, F, Br, I, CN, NO₂, (CF₂)_rCF₃, (CH₂)_rOC₁₋₅ alkyl, OH, SH, (CH₂)_rSC₁₋₅ alkyl, (CH₂)_rNR^{7f}R^{7f}, and (CH₂)_rphenyl;
- 35 alternatively, R⁷ and R⁸ join to form C₃₋₇ cycloalkyl, or =NR^{8b};

- R^{8b} is selected from H, C₁₋₆ alkyl, C₃₋₆ cycloalkyl, OH, CN, and (CH₂)_r-phenyl;
- 5 R^9 , is selected from H, C₁₋₆ alkyl, C₂₋₈ alkenyl, C₂₋₈ alkynyl, F, Cl, Br, I, NO₂, CN, (CH₂)_rOH, (CH₂)_rSH, (CH₂)_rOR^{9d}, (CH₂)_rSR^{9d}, (CH₂)_rNR^{9a}R^{9a'}, (CH₂)_rC(O)OH, (CH₂)_rC(O)R^{9b}, (CH₂)_rC(O)NR^{9a}R^{9a'}, (CH₂)_rNR^{9a}C(O)R^{9a}, (CH₂)_rNR^{9a}C(O)H, (CH₂)_rNR^{9a}C(O)NHR^{9a}, (CH₂)_rC(O)OR^{9b},
 10 (CH₂)_rOC(O)R^{9b}, (CH₂)_rOC(O)NHR^{9a}, (CH₂)_rS(O)_pR^{9b}, (CH₂)_rS(O)₂NR^{9a}R^{9a'}, (CH₂)_rNR^{9a}S(O)₂R^{9b}, C₁₋₆ haloalkyl, a (CH₂)_r-C₃₋₁₀ carbocyclic residue substituted with 0-5 R^{9c}, and a (CH₂)_r-5-10 membered heterocyclic system containing 1-4 heteroatoms selected from N, O, and S, substituted with 0-3 R^{9c};
 15
- R^{9a} and $R^{9a'}$, at each occurrence, are selected from H, C₁₋₆ alkyl, C₂₋₈ alkenyl, C₂₋₈ alkynyl, a (CH₂)_r-C₃₋₁₀ carbocyclic residue substituted with 0-5 R^{9e}, and a
 20 (CH₂)_r-5-10 membered heterocyclic system containing 1-4 heteroatoms selected from N, O, and S, substituted with 0-3 R^{9e};
- R^{9b} , at each occurrence, is selected from C₁₋₆ alkyl, C₂₋₈ alkenyl, C₂₋₈ alkynyl, a (CH₂)_r-C₃₋₆ carbocyclic residue substituted with 0-2 R^{9e}, and a (CH₂)_r-5-6 membered heterocyclic system containing 1-4 heteroatoms selected from N, O, and S, substituted with 0-3 R^{9e};
 25
- R^{9c} , at each occurrence, is selected from C₁₋₆ alkyl, C₂₋₈ alkenyl, C₂₋₈ alkynyl, (CH₂)_r-C₃₋₆ cycloalkyl, Cl, Br, I, F, (CF₂)_rCF₃, NO₂, CN, (CH₂)_rNR^{9f}R^{9f}, (CH₂)_rOH, (CH₂)_rOC₁₋₄ alkyl, (CH₂)_rSC₁₋₄ alkyl, (CH₂)_rC(O)OH, (CH₂)_rC(O)R^{9b}, (CH₂)_rC(O)NR^{9f}R^{9f}, (CH₂)_rNR^{9f}C(O)R^{9a},
 30 (CH₂)_rC(O)OC₁₋₄ alkyl, (CH₂)_rOC(O)R^{9b}, (CH₂)_rC(=NR^{9f})NR^{9f}R^{9f}, (CH₂)_rS(O)_pR^{9b}, (CH₂)_rNHC(=NR^{9f})NR^{9f}R^{9f}, (CH₂)_rS(O)₂NR^{9f}R^{9f},
 35

$(\text{CH}_2)_r\text{NR}^{9f}\text{S}(\text{O})_2\text{R}^{9b}$, and $(\text{CH}_2)_r\text{phenyl}$ substituted with 0-3 R^{9e} ;

5 R^{9d} , at each occurrence, is selected from C_{1-6} alkyl, C_{2-6} alkenyl, C_{2-6} alkynyl, a C_{3-10} carbocyclic residue substituted with 0-3 R^{9c} , and a 5-6 membered heterocyclic system containing 1-4 heteroatoms selected from the group consisting of N, O, and S substituted with 0-3 R^{9c} ;

10 R^{9e} , at each occurrence, is selected from C_{1-6} alkyl, C_{2-8} alkenyl, C_{2-8} alkynyl, $(\text{CH}_2)_r\text{C}_{3-6}$ cycloalkyl, Cl, F, Br, I, CN, NO_2 , $(\text{CF}_2)_r\text{CF}_3$, $(\text{CH}_2)_r\text{OC}_{1-5}$ alkyl, OH, SH, $(\text{CH}_2)_r\text{SC}_{1-5}$ alkyl, $(\text{CH}_2)_r\text{NR}^{9f}\text{R}^{9f}$, and $(\text{CH}_2)_r\text{phenyl}$;

15 R^{9f} , at each occurrence, is selected from H, C_{1-6} alkyl, and C_{3-6} cycloalkyl;

20 R^{10} , is selected from H, C_{1-6} alkyl, C_{2-8} alkenyl, C_{2-8} alkynyl, F, Cl, Br, I, NO_2 , CN, $(\text{CH}_2)_r\text{OH}$, $(\text{CH}_2)_r\text{OR}^{10d}$, $(\text{CH}_2)_r\text{SR}^{10d}$, $(\text{CH}_2)_r\text{NR}^{10a}\text{R}^{10a'}$, $(\text{CH}_2)_r\text{C}(\text{O})\text{OH}$, $(\text{CH}_2)_r\text{C}(\text{O})\text{R}^{10b}$, $(\text{CH}_2)_r\text{C}(\text{O})\text{NR}^{10a}\text{R}^{10a'}$, $(\text{CH}_2)_r\text{NR}^{10a}\text{C}(\text{O})\text{R}^{10a}$, $(\text{CH}_2)_r\text{NR}^{10a}\text{C}(\text{O})\text{H}$, $(\text{CH}_2)_r\text{C}(\text{O})\text{OR}^{10b}$, $(\text{CH}_2)_r\text{OC}(\text{O})\text{R}^{10b}$, $(\text{CH}_2)_r\text{S}(\text{O})_p\text{R}^{10b}$, $(\text{CH}_2)_r\text{S}(\text{O})_2\text{NR}^{10a}\text{R}^{10a'}$,
25 $(\text{CH}_2)_r\text{NR}^{10a}\text{S}(\text{O})_2\text{R}^{10b}$, C_{1-6} haloalkyl, a $(\text{CH}_2)_r\text{-C}_{3-10}$ carbocyclic residue substituted with 0-5 R^{10c} , and a $(\text{CH}_2)_r\text{-5-10}$ membered heterocyclic system containing 1-4 heteroatoms selected from N, O, and S, substituted with 0-3 R^{10c} ;

30 R^{10a} and $\text{R}^{10a'}$, at each occurrence, are selected from H, C_{1-6} alkyl, C_{2-8} alkenyl, C_{2-8} alkynyl, a $(\text{CH}_2)_r\text{-C}_{3-10}$ carbocyclic residue substituted with 0-5 R^{10e} , and a $(\text{CH}_2)_r\text{-5-10}$ membered heterocyclic system containing 1-4
35 heteroatoms selected from N, O, and S, substituted with 0-3 R^{10e} ;

- 5 R^{10b} , at each occurrence, is selected from C_{1-6} alkyl, C_{2-8} alkenyl, C_{2-8} alkynyl, a $(CH_2)_r$ - C_{3-6} carbocyclic residue substituted with 0-2 R^{10e} , and a $(CH_2)_r$ -5-6 membered heterocyclic system containing 1-4 heteroatoms selected from N, O, and S, substituted with 0-3 R^{10e} ;
- 10 R^{10c} , at each occurrence, is selected from C_{1-6} alkyl, C_{2-8} alkenyl, C_{2-8} alkynyl, $(CH_2)_r$ - C_{3-6} cycloalkyl, Cl, Br, I, F, $(CF_2)_r$ - CF_3 , NO_2 , CN, $(CH_2)_r$ - NR^{10f} - R^{10f} , $(CH_2)_r$ -OH, $(CH_2)_r$ - OC_{1-4} alkyl, $(CH_2)_r$ - SC_{1-4} alkyl, $(CH_2)_r$ - $C(O)OH$, $(CH_2)_r$ - $C(O)R^{10b}$, $(CH_2)_r$ - $C(O)NR^{10f}$ - R^{10f} , $(CH_2)_r$ - NR^{10f} - $C(O)R^{10a}$, $(CH_2)_r$ - $C(O)OC_{1-4}$ alkyl, $(CH_2)_r$ - $OC(O)R^{10b}$, $(CH_2)_r$ - $C(=NR^{10f})NR^{10f}$ - R^{10f} , $(CH_2)_r$ - $S(O)_p$ - R^{10b} , $(CH_2)_r$ - $NHC(=NR^{10f})NR^{10f}$ - R^{10f} , $(CH_2)_r$ - $S(O)_2$ - NR^{10f} - R^{10f} , $(CH_2)_r$ - NR^{10f} - $S(O)_2$ - R^{10b} , and $(CH_2)_r$ -phenyl substituted with 0-3 R^{10e} ;
- 20 R^{10d} , at each occurrence, is selected from C_{1-6} alkyl, C_{2-6} alkenyl, C_{2-6} alkynyl, a C_{3-10} carbocyclic residue substituted with 0-3 R^{10c} , and a 5-6 membered heterocyclic system containing 1-4 heteroatoms selected from the group consisting of N, O, and S substituted with 0-3 R^{10c} ;
- 25 R^{10e} , at each occurrence, is selected from C_{1-6} alkyl, C_{2-8} alkenyl, C_{2-8} alkynyl, $(CH_2)_r$ - C_{3-6} cycloalkyl, Cl, F, Br, I, CN, NO_2 , $(CF_2)_r$ - CF_3 , $(CH_2)_r$ - OC_{1-5} alkyl, OH, SH, $(CH_2)_r$ - SC_{1-5} alkyl, $(CH_2)_r$ - NR^{10f} - R^{10f} , and $(CH_2)_r$ -phenyl;
- 30 R^{10f} , at each occurrence, is selected from H, C_{1-5} alkyl, and C_{3-6} cycloalkyl;
- alternatively, R^9 and R^{10} join to form C_{3-7} cycloalkyl, 5-6-membered cyclic ketal or =O;

35

with the proviso that when R¹⁰ is -OH, R⁹ is not halogen, cyano, or bonded to the carbon to which it is attached through a heteroatom;

- 5 R¹¹, is selected from H, C₁₋₆ alkyl, C₂₋₈ alkenyl, C₂₋₈ alkynyl, (CH₂)_qOH, (CH₂)_qSH, (CH₂)_qOR^{11d}, (CH₂)_qSR^{11d}, (CH₂)_qNR^{11a}R^{11a'}, (CH₂)_rC(O)OH, (CH₂)_rC(O)R^{11b}, (CH₂)_rC(O)NR^{11a}R^{11a'}, (CH₂)_qNR^{11a}C(O)R^{11a}, (CH₂)_qNR^{11a}C(O)NHR^{11a}, (CH₂)_rC(O)OR^{11b}, (CH₂)_qOC(O)R^{11b}, 10 (CH₂)_qS(O)_pR^{11b}, (CH₂)_qS(O)₂NR^{11a}R^{11a'}, (CH₂)_qNR^{11a}S(O)₂R^{11b}, C₁₋₆ haloalkyl, a (CH₂)_r-C₃₋₁₀ carbocyclic residue substituted with 0-5 R^{11c}, and a (CH₂)_r-5-10 membered heterocyclic system containing 1-4 heteroatoms selected from N, O, and S, substituted 15 with 0-3 R^{11c};
- R^{11a} and R^{11a'}, at each occurrence, are selected from H, C₁₋₆ alkyl, C₂₋₈ alkenyl, C₂₋₈ alkynyl, a (CH₂)_r-C₃₋₁₀ carbocyclic residue substituted with 0-5 R^{11e}, and a 20 (CH₂)_r-5-10 membered heterocyclic system containing 1-4 heteroatoms selected from N, O, and S, substituted with 0-3 R^{11e};
- R^{11b}, at each occurrence, is selected from C₁₋₆ alkyl, C₂₋₈ alkenyl, C₂₋₈ alkynyl, a (CH₂)_r-C₃₋₆ carbocyclic residue substituted with 0-2 R^{11e}, and a (CH₂)_r-5-6 membered heterocyclic system containing 1-4 heteroatoms 25 selected from N, O, and S, substituted with 0-3 R^{11e};
- R^{11c}, at each occurrence, is selected from C₁₋₆ alkyl, C₂₋₈ alkenyl, C₂₋₈ alkynyl, (CH₂)_r-C₃₋₆ cycloalkyl, Cl, Br, I, F, (CF₂)_rCF₃, NO₂, CN, (CH₂)_rNR^{11f}R^{11f}, (CH₂)_rOH, (CH₂)_rOC₁₋₄ alkyl, (CH₂)_rSC₁₋₄ alkyl, (CH₂)_rC(O)OH, (CH₂)_rC(O)R^{11b}, (CH₂)_rC(O)NR^{11f}R^{11f}, (CH₂)_rNR^{11f}C(O)R^{11a}, 30 (CH₂)_rC(O)OC₁₋₄ alkyl, (CH₂)_rOC(O)R^{11b}, (CH₂)_rC(=NR^{11f})NR^{11f}R^{11f}, (CH₂)_rNHC(=NR^{11f})NR^{11f}R^{11f}, 35 (CH₂)_rS(O)_pR^{11b}, (CH₂)_rS(O)₂NR^{11f}R^{11f},

$(\text{CH}_2)_r\text{NR}^{11f}\text{S}(\text{O})_2\text{R}^{11b}$, and $(\text{CH}_2)_r$ phenyl substituted with 0-3 R^{11e} ;

5 R^{11d} , at each occurrence, is selected from C_{1-6} alkyl substituted with 0-3 R^{11e} , C_{2-6} alkenyl, C_{2-6} alkynyl, and a C_{3-10} carbocyclic residue substituted with 0-3 R^{11c} ;

10 R^{11e} , at each occurrence, is selected from C_{1-6} alkyl, C_{2-8} alkenyl, C_{2-8} alkynyl, C_{3-6} cycloalkyl, Cl, F, Br, I, CN, NO_2 , $(\text{CF}_2)_r\text{CF}_3$, $(\text{CH}_2)_r\text{OC}_{1-5}$ alkyl, OH, SH, $(\text{CH}_2)_r\text{SC}_{1-5}$ alkyl, $(\text{CH}_2)_r\text{NR}^{11f}\text{R}^{11f}$, and $(\text{CH}_2)_r$ phenyl;

15 R^{11f} , at each occurrence, is selected from H, C_{1-6} alkyl, and C_{3-6} cycloalkyl;

R^{12} is selected from H, C_{1-6} alkyl, $(\text{CH}_2)_q\text{OH}$, $(\text{CH}_2)_r\text{C}_{3-6}$ cycloalkyl, and $(\text{CH}_2)_t$ phenyl substituted with 0-3 R^{12a} ;

20 R^{12a} , at each occurrence, is selected from C_{1-6} alkyl, C_{2-8} alkenyl, C_{2-8} alkynyl, C_{3-6} cycloalkyl, Cl, F, Br, I, CN, NO_2 , $(\text{CF}_2)_r\text{CF}_3$, $(\text{CH}_2)_r\text{OC}_{1-5}$ alkyl, OH, SH, $(\text{CH}_2)_r\text{SC}_{1-5}$ alkyl, $(\text{CH}_2)_r\text{NR}^{9f}\text{R}^{9f}$, and $(\text{CH}_2)_r$ phenyl;

25 alternatively, R^{11} and R^{12} join to form C_{3-7} cycloalkyl;

30 R^{13} , at each occurrence, is selected from C_{1-6} alkyl, C_{2-8} alkenyl, C_{2-8} alkynyl, C_{3-6} cycloalkyl, $(\text{CF}_2)_w\text{CF}_3$, $(\text{CH}_2)\text{NR}^{13a}\text{R}^{13a'}$, $(\text{CH}_2)\text{OH}$, $(\text{CH}_2)\text{OR}^{13b}$, $(\text{CH}_2)\text{SH}$, $(\text{CH}_2)\text{SR}^{13b}$, $(\text{CH}_2)_w\text{C}(\text{O})\text{OH}$, $(\text{CH}_2)_w\text{C}(\text{O})\text{R}^{13b}$, $(\text{CH}_2)_w\text{C}(\text{O})\text{NR}^{13a}\text{R}^{13a'}$, $(\text{CH}_2)\text{NR}^{13d}\text{C}(\text{O})\text{R}^{13a}$, $(\text{CH}_2)_w\text{C}(\text{O})\text{OR}^{13b}$, $(\text{CH}_2)\text{OC}(\text{O})\text{R}^{13b}$, $(\text{CH}_2)_w\text{S}(\text{O})_p\text{R}^{13b}$, $(\text{CH}_2)_w\text{S}(\text{O})_2\text{NR}^{13a}\text{R}^{13a'}$, $(\text{CH}_2)\text{NR}^{13d}\text{S}(\text{O})_2\text{R}^{13b}$, and $(\text{CH}_2)_w$ -phenyl substituted with 0-3 R^{13c} ;

35

- R^{13a} and R^{13a'}, at each occurrence, are selected from H, C₁₋₆ alkyl, C₃₋₆ cycloalkyl, and phenyl substituted with 0-3 R^{13c};
- 5 R^{13b}, at each occurrence, is selected from C₁₋₆ alkyl, C₃₋₆ cycloalkyl, and phenyl substituted with 0-3 R^{13c};
- R^{13c}, at each occurrence, is selected from C₁₋₆ alkyl, C₃₋₆ cycloalkyl, Cl, F, Br, I, CN, NO₂, (CF₂)_rCF₃, (CH₂)_rOC₁₋₅ alkyl, (CH₂)_rOH, (CH₂)_rSC₁₋₅ alkyl, and
 10 (CH₂)_rNR^{13d}R^{13d};
- R^{13d}, at each occurrence, is selected from H, C₁₋₆ alkyl, and C₃₋₆ cycloalkyl;
- 15 R¹⁴, at each occurrence, is selected from C₁₋₆ alkyl, C₂₋₈ alkenyl, C₂₋₈ alkynyl, (CH₂)_rC₃₋₆ cycloalkyl, Cl, Br, I, F, NO₂, CN, (CHR')_rNR^{14a}R^{14a'}, (CHR')_rOH, (CHR')_rO(CHR')_rR^{14d}, (CHR')_rSH, (CHR')_rC(O)H, (CHR')_rS(CHR')_rR^{14d}, (CHR')_rC(O)OH,
 20 (CHR')_rC(O)(CHR')_rR^{14b}, (CHR')_rC(O)NR^{14a}R^{14a'}, (CHR')_rNR^{14f}C(O)(CHR')_rR^{14b}, (CHR')_rC(O)O(CHR')_rR^{14d}, (CHR')_rOC(O)(CHR')_rR^{14b}, (CHR')_rC(=NR^{14f})NR^{14a}R^{14a'}, (CHR')_rNHC(=NR^{14f})NR^{14f}R^{14f}, (CHR')_rS(O)_p(CHR')_rR^{14b},
 25 (CHR')_rS(O)₂NR^{14a}R^{14a'}, (CHR')_rNR^{14f}S(O)₂(CHR')_rR^{14b}, C₁₋₆ haloalkyl, C₂₋₈ alkenyl substituted with 0-3 R', C₂₋₈ alkynyl substituted with 0-3 R', (CHR')_rphenyl substituted with 0-3 R^{14e}, and a (CH₂)_r-5-10 membered heterocyclic system containing 1-4 heteroatoms
 30 selected from N, O, and S, substituted with 0-2 R^{15e};
- R', at each occurrence, is selected from H, C₁₋₆ alkyl, C₂₋₈ alkenyl, C₂₋₈ alkynyl, (CH₂)_rC₃₋₆ cycloalkyl, and (CH₂)_rphenyl substituted with R^{14e};
- 35 R^{14a} and R^{14a'}, at each occurrence, are selected from H, C₁₋₆ alkyl, C₂₋₈ alkenyl, C₂₋₈ alkynyl, a (CH₂)_r-C₃₋₁₀

carbocyclic residue substituted with 0-5 R^{14e}, and a (CH₂)_r-5-10 membered heterocyclic system containing 1-4 heteroatoms selected from N, O, and S, substituted with 0-2 R^{14e};

5

R^{14b}, at each occurrence, is selected from C₁₋₆ alkyl, C₂₋₈ alkenyl, C₂₋₈ alkynyl, a (CH₂)_r-C₃₋₆ carbocyclic residue substituted with 0-3 R^{14e}, and (CH₂)_r-5-6 membered heterocyclic system containing 1-4 heteroatoms selected from N, O, and S, substituted with 0-2 R^{14e};

10

R^{14d}, at each occurrence, is selected from C₂₋₈ alkenyl, C₂₋₈ alkynyl, C₁₋₆ alkyl substituted with 0-3 R^{14e}, a (CH₂)_r-C₃₋₁₀ carbocyclic residue substituted with 0-3 R^{14e}, and a (CH₂)_r-5-6 membered heterocyclic system containing 1-4 heteroatoms selected from N, O, and S, substituted with 0-3 R^{14e};

15

R^{14e}, at each occurrence, is selected from C₁₋₆ alkyl, C₂₋₈ alkenyl, C₂₋₈ alkynyl, (CH₂)_r-C₃₋₆ cycloalkyl, Cl, F, Br, I, CN, NO₂, (CF₂)_rCF₃, (CH₂)_rOC₁₋₅ alkyl, OH, SH, (CH₂)_rSC₁₋₅ alkyl, (CH₂)_rNR^{14f}R^{14f}, and (CH₂)_rphenyl;

20

R^{14f}, at each occurrence, is selected from H, C₁₋₆ alkyl, C₃₋₆ cycloalkyl, and phenyl;

25

alternatively, R¹⁴ joins with R⁴ to form a 5, 6 or 7 membered piperidinium spirocycle or pyrrolidinium spirocycle fused to ring A, the spirocycle substituted with 0-3 R^a;

30

R¹⁵, at each occurrence, is selected from C₁₋₆ alkyl, C₂₋₈ alkenyl, C₂₋₈ alkynyl, (CH₂)_r-C₃₋₆ cycloalkyl, Cl, Br, I, F, NO₂, CN, (CHR')_rNR^{15a}R^{15a'}, (CHR')_rOH, (CHR')_rO(CHR')_rR^{15d}, (CHR')_rSH, (CHR')_rC(O)H, (CHR')_rS(CHR')_rR^{15d}, (CHR')_rC(O)OH, (CHR')_rC(O)(CHR')_rR^{15b}, (CHR')_rC(O)NR^{15a}R^{15a'},

35

(CHR')_rNR^{15f}C(O)(CHR')_rR^{15b}, (CHR')_rC(O)O(CHR')_rR^{15d},
 (CHR')_rOC(O)(CHR')_rR^{15b}, (CHR')_rC(O)NR^{15a}R^{15a'},
 (CHR')_rC(=NR^{15f})NR^{15a}R^{15a'}, (CHR')_rNHC(=NR^{15f})NR^{15f}R^{15f},
 (CHR')_rS(O)_p(CHR')_rR^{15b}, (CHR')_rS(O)₂NR^{15a}R^{15a'},
 5 (CHR')_rNR^{15f}S(O)₂(CHR')_rR^{15b}, C₁₋₆ haloalkyl, C₂₋₈
 alkenyl substituted with 0-3 R', C₂₋₈ alkynyl
 substituted with 0-3 R', (CHR')_rphenyl substituted with
 0-3 R^{15e}, and a (CH₂)_{r-5-10} membered heterocyclic
 system containing 1-4 heteroatoms selected from N, O,
 10 and S, substituted with 0-2 R^{15e};

R^{15a} and R^{15a'}, at each occurrence, are selected from H, C₁₋₆
 alkyl, C₂₋₈ alkenyl, C₂₋₈ alkynyl, a (CH₂)_{r-C3-10}
 carbocyclic residue substituted with 0-5 R^{15e}, and a
 15 (CH₂)_{r-5-10} membered heterocyclic system containing 1-4
 heteroatoms selected from N, O, and S, substituted
 with 0-2 R^{15e};

R^{15b}, at each occurrence, is selected from C₁₋₆ alkyl, C₂₋₈
 20 alkenyl, C₂₋₈ alkynyl, a (CH₂)_{r-C3-6} carbocyclic residue
 substituted with 0-3 R^{15e}, and (CH₂)_{r-5-6} membered
 heterocyclic system containing 1-4 heteroatoms
 selected from N, O, and S, substituted with 0-2 R^{15e};

R^{15d}, at each occurrence, is selected from C₂₋₈ alkenyl, C₂₋₈
 25 alkynyl, C₁₋₆ alkyl substituted with 0-3 R^{15e}, a
 (CH₂)_{r-C3-10} carbocyclic residue substituted with 0-3
 R^{15e}, and a (CH₂)_{r-5-6} membered heterocyclic system
 containing 1-4 heteroatoms selected from N, O, and S,
 30 substituted with 0-3 R^{15e};

R^{15e}, at each occurrence, is selected from C₁₋₆ alkyl, C₂₋₈
 alkenyl, C₂₋₈ alkynyl, (CH₂)_{r-C3-6} cycloalkyl, Cl, F, Br,
 I, CN, NO₂, (CF₂)_rCF₃, (CH₂)_rOC₁₋₅ alkyl, OH, SH,
 35 (CH₂)_rSC₁₋₅ alkyl, (CH₂)_rNR^{15f}R^{15f}, and (CH₂)_rphenyl;

- R^{15f}, at each occurrence, is selected from H, C₁₋₆ alkyl, C₃₋₆ cycloalkyl, and phenyl;
- R¹⁶, at each occurrence, is selected from C₁₋₆ alkyl, C₂₋₈ alkenyl, C₂₋₈ alkynyl, (CH₂)_rC₃₋₆ cycloalkyl, Cl, Br, I, F, NO₂, CN, (CHR')_rNR^{16a}R^{16a'}, (CHR')_rOH, (CHR')_rO(CHR')_rR^{16d}, (CHR')_rSH, (CHR')_rC(O)H, (CHR')_rS(CHR')_rR^{16d}, (CHR')_rC(O)OH, (CHR')_rC(O)(CHR')_rR^{16b}, (CHR')_rC(O)NR^{16a}R^{16a'}, (CHR')_rNR^{16f}C(O)(CHR')_rR^{16b}, (CHR')_rC(O)O(CHR')_rR^{16d}, (CHR')_rOC(O)(CHR')_rR^{16b}, (CHR')_rC(=NR^{16f})NR^{16a}R^{16a'}, (CHR')_rNHC(=NR^{16f})NR^{16f}R^{16f}, (CHR')_rS(O)_p(CHR')_rR^{16b}, (CHR')_rS(O)₂NR^{16a}R^{16a'}, (CHR')_rNR^{16f}S(O)₂(CHR')_rR^{16b}, C₁₋₆ haloalkyl, C₂₋₈ alkenyl substituted with 0-3 R', C₂₋₈ alkynyl substituted with 0-3 R', and (CHR')_rphenyl substituted with 0-3 R^{16e};
- R^{16a} and R^{16a'}, at each occurrence, are selected from H, C₁₋₆ alkyl, C₂₋₈ alkenyl, C₂₋₈ alkynyl, a (CH₂)_r-C₃₋₁₀ carbocyclic residue substituted with 0-5 R^{16e}, and a (CH₂)_r-5-10 membered heterocyclic system containing 1-4 heteroatoms selected from N, O, and S, substituted with 0-2 R^{16e};
- R^{16b}, at each occurrence, is selected from C₁₋₆ alkyl, C₂₋₈ alkenyl, C₂₋₈ alkynyl, a (CH₂)_rC₃₋₆ carbocyclic residue substituted with 0-3 R^{16e}, and a (CH₂)_r-5-6 membered heterocyclic system containing 1-4 heteroatoms selected from N, O, and S, substituted with 0-2 R^{16e};
- R^{16d}, at each occurrence, is selected from C₂₋₈ alkenyl, C₂₋₈ alkynyl, C₁₋₆ alkyl substituted with 0-3 R^{16e}, a (CH₂)_r-C₃₋₁₀ carbocyclic residue substituted with 0-3 R^{16e}, and a (CH₂)_r-5-6 membered heterocyclic system containing 1-4 heteroatoms selected from N, O, and S, substituted with 0-3 R^{16e};

R^{16e} , at each occurrence, is selected from C_{1-6} alkyl, C_{2-8} alkenyl, C_{2-8} alkynyl, $(CH_2)_r C_{3-6}$ cycloalkyl, Cl, F, Br, I, CN, NO_2 , $(CF_2)_r CF_3$, $(CH_2)_r OC_{1-5}$ alkyl, OH, SH, $(CH_2)_r SC_{1-5}$ alkyl, $(CH_2)_r NR^{16f} R^{16f}$, and $(CH_2)_r$ phenyl;

5

R^{16f} , at each occurrence, is selected from H, C_{1-6} alkyl, and C_{3-6} cycloalkyl, and phenyl;

g is selected from 0, 1, 2, 3, and 4;

10

v is selected from 0, 1, and 2;

t is selected from 1 and 2;

15

w is selected from 0 and 1;

r is selected from 0, 1, 2, 3, 4, and 5;

q is selected from 1, 2, 3, 4, and 5; and

20

p is selected from 1, 2, and 3.

30. The compound of claim 29, wherein:

25 E is selected from:

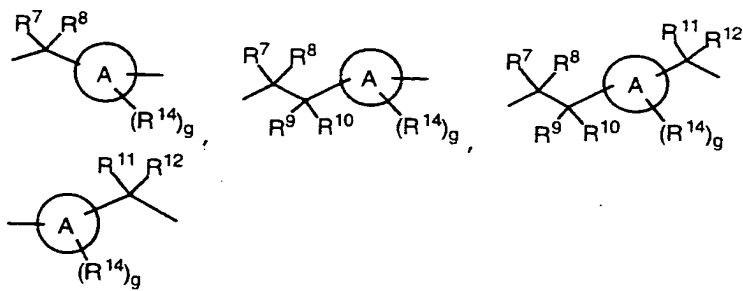

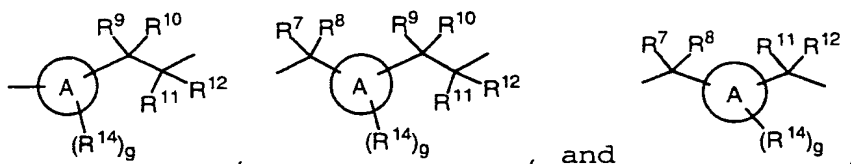

R⁴ is absent, taken with the nitrogen to which it is attached to form an N-oxide, or selected from C₁₋₈ alkyl, (CH₂)_rC₃₋₆ cycloalkyl, and (CH₂)_r-phenyl substituted with 0-3 R^{4c};

R^{4c}, at each occurrence, is selected from C₁₋₆ alkyl, C₂₋₈ alkenyl, C₂₋₈ alkynyl, C₃₋₆ cycloalkyl, Cl, F, Br, I, CN, NO₂, (CF₂)_rCF₃, (CH₂)_rOC₁₋₅ alkyl, (CH₂)_rOH, (CH₂)_rSC₁₋₅ alkyl, (CH₂)_rNR^{4a}R^{4a'}, and (CH₂)_rphenyl;

alternatively, R⁴ joins with R⁷ or R⁹ to form a 5, 6 or 7 membered piperidinium spirocycle substituted with 0-3 R^a;

R¹ and R² are independently selected from H and C₁₋₄ alkyl;

R⁶, at each occurrence, is selected from C₁₋₄ alkyl, C₂₋₈ alkenyl, C₂₋₈ alkynyl, (CH₂)_rC₃₋₆ cycloalkyl, (CF₂)_rCF₃, CN, (CH₂)_rOH, (CH₂)_rOR^{6b}, (CH₂)_rC(O)R^{6b}, (CH₂)_rC(O)NR^{6a}R^{6a'}, (CH₂)_rNR^{6d}C(O)R^{6a}, and (CH₂)_tphenyl substituted with 0-3 R^{6c};

R^{6a} and R^{6a'}, at each occurrence, are selected from H, C₁₋₆ alkyl, C₃₋₆ cycloalkyl, and phenyl substituted with 0-3 R^{6c};

R^{6b}, at each occurrence, is selected from C₁₋₆ alkyl, C₃₋₆ cycloalkyl, and phenyl substituted with 0-3 R^{6c};

R^{6c}, at each occurrence, is selected from C₁₋₆ alkyl, C₃₋₆ cycloalkyl, Cl, F, Br, I, CN, NO₂, (CF₂)_rCF₃, (CH₂)_rOC₁₋₅ alkyl, (CH₂)_rOH, (CH₂)_rSC₁₋₅ alkyl, and (CH₂)_rNR^{6d}R^{6d};

- R^{6d} , at each occurrence, is selected from H, C_{1-6} alkyl, and C_{3-6} cycloalkyl;
- 5 R^7 , is selected from H, C_{1-3} alkyl, $(CH_2)_r C_{3-6}$ cycloalkyl, $(CH_2)_q OH$, $(CH_2)_q OR^{7d}$, $(CH_2)_q NR^{7a} R^{7a'}$, $(CH_2)_r C(O) R^{7b}$, $(CH_2)_r C(O) NR^{7a} R^{7a'}$, $(CH_2)_q NR^{7a} C(O) R^{7a}$, C_{1-6} haloalkyl, $(CH_2)_r$ phenyl with 0-2 R^{7c} ;
- 10 R^{7a} and $R^{7a'}$, at each occurrence, are selected from H, C_{1-6} alkyl, $(CH_2)_r C_{3-6}$ cycloalkyl, a $(CH_2)_r$ phenyl substituted with 0-3 R^{7e} ;
- 15 R^{7b} , at each occurrence, is selected from C_{1-6} alkyl, C_{2-8} alkenyl, C_{2-8} alkynyl, $(CH_2)_r C_{3-6}$ cycloalkyl, $(CH_2)_r$ phenyl substituted with 0-3 R^{7e} ;
- 20 R^{7c} , at each occurrence, is selected from C_{1-4} alkyl, C_{2-8} alkenyl, C_{2-8} alkynyl, $(CH_2)_r C_{3-6}$ cycloalkyl, Cl, Br, I, F, $(CF_2)_r CF_3$, NO_2 , CN, $(CH_2)_r NR^{7f} R^{7f}$, $(CH_2)_r OH$, $(CH_2)_r OC_{1-4}$ alkyl, $(CH_2)_r C(O) R^{7b}$, $(CH_2)_r C(O) NR^{7f} R^{7f}$, $(CH_2)_r NR^{7f} C(O) R^{7a}$, $(CH_2)_r S(O)_p R^{7b}$, $(CH_2)_r S(O)_2 NR^{7f} R^{7f}$, $(CH_2)_r NR^{7f} S(O)_2 R^{7b}$, and $(CH_2)_r$ phenyl substituted with 0-2 R^{7e} ;
- 25 R^{7d} , at each occurrence, is selected from C_{1-6} alkyl, $(CH_2)_r C_{3-6}$ cycloalkyl, $(CH_2)_r$ phenyl substituted with 0-3 R^{7e} ;
- 30 R^{7e} , at each occurrence, is selected from C_{1-6} alkyl, C_{2-8} alkenyl, C_{2-8} alkynyl, C_{3-6} cycloalkyl, Cl, F, Br, I, CN, NO_2 , $(CF_2)_r CF_3$, $(CH_2)_r OC_{1-5}$ alkyl, OH, SH, $(CH_2)_r SC_{1-5}$ alkyl, $(CH_2)_r NR^{7f} R^{7f}$, and $(CH_2)_r$ phenyl;
- 35 R^{7f} , at each occurrence, is selected from H, C_{1-5} alkyl, and C_{3-6} cycloalkyl;

- R^8 is H or joins with R^7 to form C_{3-7} cycloalkyl or $=NR^{8b}$;
- R^{11} , is selected from H, C_{1-6} alkyl, $(CH_2)_rC_{3-6}$ cycloalkyl, $(CH_2)_qOH$, $(CH_2)_qOR^{11d}$, $(CH_2)_qNR^{11a}R^{11a'}$, $(CH_2)_rC(O)R^{11b}$,
 5 $(CH_2)_rC(O)NR^{11a}R^{11a'}$, $(CH_2)_qNR^{11a}C(O)R^{11a}$, C_{1-6} haloalkyl, $(CH_2)_r$ phenyl with 0-2 R^{11c} , $(CH_2)_{r-5-10}$ membered heterocyclic system containing 1-4 heteroatoms selected from N, O, and S, substituted with 0-3 R^{15} ;
- 10 R^{11a} and $R^{11a'}$, at each occurrence, are selected from H, C_{1-6} alkyl, $(CH_2)_rC_{3-6}$ cycloalkyl, a $(CH_2)_r$ phenyl substituted with 0-3 R^{11e} ;
- R^{11b} , at each occurrence, is selected from C_{1-6} alkyl, C_{2-8}
 15 alkenyl, C_{2-8} alkynyl, $(CH_2)_rC_{3-6}$ cycloalkyl, $(CH_2)_r$ phenyl substituted with 0-3 R^{11e} ;
- R^{11c} , at each occurrence, is selected from C_{1-4} alkyl, C_{2-8}
 20 alkenyl, C_{2-8} alkynyl, $(CH_2)_rC_{3-6}$ cycloalkyl, Cl, Br, I, F, $(CF_2)_rCF_3$, NO_2 , CN, $(CH_2)_rNR^{11f}R^{11f}$, $(CH_2)_rOH$, $(CH_2)_rOC_{1-4}$ alkyl, $(CH_2)_rC(O)R^{11b}$, $(CH_2)_rC(O)NR^{11f}R^{11f}$, $(CH_2)_rNR^{11f}C(O)R^{11a}$, $(CH_2)_rS(O)_pR^{11b}$, $(CH_2)_rS(O)_2NR^{11f}R^{11f}$, $(CH_2)_rNR^{11f}S(O)_2R^{11b}$, and $(CH_2)_r$ phenyl substituted with 0-2 R^{11e} ;
- 25 R^{11d} , at each occurrence, is selected from C_{1-6} alkyl, $(CH_2)_rC_{3-6}$ cycloalkyl, $(CH_2)_r$ phenyl substituted with 0-3 R^{11e} ;
- 30 R^{11e} , at each occurrence, is selected from C_{1-6} alkyl, C_{2-8} alkenyl, C_{2-8} alkynyl, C_{3-6} cycloalkyl, Cl, F, Br, I, CN, NO_2 , $(CF_2)_rCF_3$, $(CH_2)_rOC_{1-5}$ alkyl, OH, SH, $(CH_2)_rSC_{1-5}$ alkyl, $(CH_2)_rNR^{11f}R^{11f}$, and $(CH_2)_r$ phenyl;
- 35 R^{11f} , at each occurrence, is selected from H, C_{1-5} alkyl and C_{3-6} cycloalkyl;

- R¹² is H or joins with R¹¹ to form C₃₋₇ cycloalkyl;
- R¹³, at each occurrence, is selected from C₁₋₄ alkyl, C₃₋₆ cycloalkyl, (CH₂)NR^{13a}R^{13a'}, (CH₂)OH, (CH₂)OR^{13b},
5 (CH₂)_wC(O)R^{13b}, (CH₂)_wC(O)NR^{13a}R^{13a'}, (CH₂)NR^{13d}C(O)R^{13a},
(CH₂)_wS(O)₂NR^{13a}R^{13a'}, (CH₂)NR^{13d}S(O)₂R^{13b}, and
(CH₂)_w-phenyl substituted with 0-3 R^{13c};
- R^{13a} and R^{13a'}, at each occurrence, are selected from H, C₁₋₆
10 alkyl, C₃₋₆ cycloalkyl, and phenyl substituted with 0-3
R^{13c};
- R^{13b}, at each occurrence, is selected from C₁₋₆ alkyl, C₃₋₆
cycloalkyl, and phenyl substituted with 0-3 R^{13c};
- 15 R^{13c}, at each occurrence, is selected from C₁₋₆ alkyl, C₃₋₆
cycloalkyl, Cl, F, Br, I, CN, NO₂, (CF₂)_rCF₃, (CH₂)_rOC₁₋₅
alkyl, (CH₂)_rOH, and (CH₂)_rNR^{13d}R^{13d};
- 20 R^{13d}, at each occurrence, is selected from H, C₁₋₆ alkyl,
and C₃₋₆ cycloalkyl;
- v is selected from 1 and 2;
- 25 q is selected from 1, 2, and 3; and
- r is selected from 0, 1, 2, and 3.
31. The compound of claim 30, wherein:
- 30 ring A is selected from:

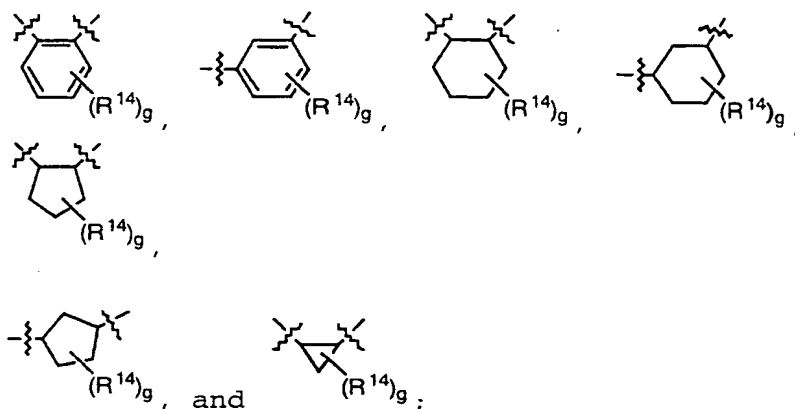

5

R³ is selected from a (CR^{3'}H)_r-carbocyclic residue substituted with 0-5 R¹⁵, wherein the carbocyclic residue is selected from phenyl, C₃₋₆ cycloalkyl, naphthyl, and adamantyl; and a (CR^{3'}H)_r-heterocyclic system substituted with 0-3 R¹⁵, wherein the heterocyclic system is selected from pyridinyl, thiophenyl, furanyl, indazolyl, benzothiazolyl, benzimidazolyl, benzothiophenyl, benzofuranyl, benzoxazolyl, benzisoxazolyl, quinolinyl, isoquinolinyl, imidazolyl, indolyl, indolinyl, isoindolyl, isothiadiazolyl, isoxazolyl, piperidinyl, pyrrazolyl, 1,2,4-triazolyl, 1,2,3-triazolyl, tetrazolyl, thiadiazolyl, thiazolyl, oxazolyl, pyrazinyl, and pyrimidinyl; and

20

R⁵ is selected from (CR^{5'}H)_t-phenyl substituted with 0-5 R¹⁶; and a (CR^{5'}H)_t-heterocyclic system substituted with 0-3 R¹⁶, wherein the heterocyclic system is selected from pyridinyl, thiophenyl, furanyl, indazolyl, benzothiazolyl, benzimidazolyl, benzothiophenyl, benzofuranyl, benzoxazolyl, benzisoxazolyl, quinolinyl, isoquinolinyl, imidazolyl, indolyl, isoindolyl, piperidinyl, pyrrazolyl, 1,2,4-triazolyl, 1,2,3-triazolyl, tetrazolyl, thiazolyl, oxazolyl, pyrazinyl, and pyrimidinyl.

30

32. The compound of claim 31, wherein the compound of formula (I) is:

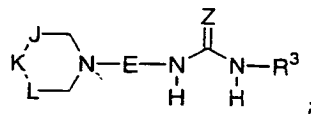

5 R¹⁶, at each occurrence, is selected from C₁₋₈ alkyl,
 (CH₂)_rC₃₋₆ cycloalkyl, CF₃, Cl, Br, I, F,
 (CH₂)_rNR^{16a}R^{16a'}, NO₂, CN, OH, (CH₂)_rOR^{16d},
 (CH₂)_rC(O)R^{16b}, (CH₂)_rC(O)NR^{16a}R^{16a'}, (CH₂)_rNR^{16f}C(O)R^{16b},
 (CH₂)_rS(O)_pR^{16b}, (CH₂)_rS(O)₂NR^{16a}R^{16a'},
 10 (CH₂)_rNR^{16f}S(O)₂R^{16b}, and (CH₂)_rphenyl substituted with
 0-3 R^{16e};

R^{16a} and R^{16a'}, at each occurrence, are selected from H, C₁₋₆
 alkyl, C₃₋₆ cycloalkyl, and (CH₂)_rphenyl substituted
 15 with 0-3 R^{16e};

R^{16b}, at each occurrence, is selected from H, C₁₋₆ alkyl,
 C₃₋₆ cycloalkyl, and (CH₂)_rphenyl substituted with 0-3
 R^{16e};

20 R^{16d}, at each occurrence, is selected from C₁₋₆ alkyl and
 phenyl;

R^{16e}, at each occurrence, is selected from C₁₋₆ alkyl, Cl,
 25 F, Br, I, CN, NO₂, (CF₂)_rCF₃, OH, and (CH₂)_rOC₁₋₅ alkyl;
 and

R^{16f}, at each occurrence, is selected from H, and C₁₋₅
 alkyl.

30

33. The compound of claim 31, wherein the compound of formula (I) is:

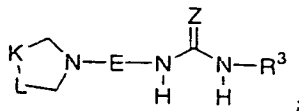

- R^{16} , at each occurrence, is selected from C_{1-8} alkyl,
 $(CH_2)_r C_{3-6}$ cycloalkyl, CF_3 , Cl, Br, I, F,
 $(CH_2)_r NR^{16a} R^{16a'}$, NO_2 , CN, OH, $(CH_2)_r OR^{16d}$,
 5 $(CH_2)_r C(O)R^{16b}$, $(CH_2)_r C(O)NR^{16a} R^{16a'}$, $(CH_2)_r NR^{16f} C(O)R^{16b}$,
 $(CH_2)_r S(O)_p R^{16b}$, $(CH_2)_r S(O)_2 NR^{16a} R^{16a'}$,
 $(CH_2)_r NR^{16f} S(O)_2 R^{16b}$, and $(CH_2)_r$ phenyl substituted with
 0-3 R^{16e} ;
- 10 R^{16a} and $R^{16a'}$, at each occurrence, are selected from H, C_{1-6}
 alkyl, C_{3-6} cycloalkyl, and $(CH_2)_r$ phenyl substituted
 with 0-3 R^{16e} ;
- R^{16b} , at each occurrence, is selected from H, C_{1-6} alkyl,
 15 C_{3-6} cycloalkyl, and $(CH_2)_r$ phenyl substituted with 0-3
 R^{16e} ;
- R^{16d} , at each occurrence, is selected from C_{1-6} alkyl and
 phenyl;
- 20 R^{16e} , at each occurrence, is selected from C_{1-6} alkyl, Cl,
 F, Br, I, CN, NO_2 , $(CF_2)_r CF_3$, OH, and $(CH_2)_r OC_{1-5}$ alkyl;
 and
- 25 R^{16f} , at each occurrence, is selected from H, and C_{1-5}
 alkyl.

34. The compound of claim 32, wherein:

- 30 R^5 is CH_2 phenyl substituted with 0-3 R^{16} ;
- R^9 , is selected from H, C_{1-6} alkyl, $(CH_2)_r C_{3-6}$ cycloalkyl, F,
 Cl, CN, $(CH_2)_r OH$, $(CH_2)_r OR^{9d}$, $(CH_2)_r NR^{9a} R^{9a'}$,
 $(CH_2)_r OC(O)NHR^{9a}$, $(CH_2)_r$ phenyl substituted with 0-5 R^{9e} ,
 35 and a heterocyclic system substituted with 0-2 R^{9e} ,
 wherein the heterocyclic system is selected from
 pyridyl, thiophenyl, furanyl, oxazolyl, and thiazolyl;

R^{9a} and R^{9a'}, at each occurrence, are selected from H, C₁₋₆ alkyl, C₃₋₆ cycloalkyl, and (CH₂)_rphenyl substituted with 0-3 R^{9e};

5

R^{9d}, at each occurrence, is selected from C₁₋₆ alkyl and phenyl;

R^{9e}, at each occurrence, is selected from C₁₋₆ alkyl, Cl, F, Br, I, CN, NO₂, (CF₂)_rCF₃, OH, and (CH₂)_rOC₁₋₅ alkyl;

10

R¹⁰ is selected from H, C₁₋₅ alkyl, OH, and CH₂OH;

alternatively, R⁹ and R¹⁰ join to form C₃₋₇ cycloalkyl, 5-6-membered cyclic ketal or =O;

15

with the proviso that when R¹⁰ is -OH, R⁹ is not halogen, cyano, or bonded to the carbon to which it is attached through a heteroatom;

20

R¹¹ is selected from H, C₁₋₈ alkyl, (CH₂)_rphenyl substituted with 0-5 R^{11e}, and a (CH₂)_r-heterocyclic system substituted with 0-2 R^{11e}, wherein the heterocyclic system is selected from pyridinyl, thiophenyl, furanyl, indazolyl, benzothiazolyl, benzimidazolyl, benzothiophenyl, benzofuranyl, benzoxazolyl, benzisoxazolyl, quinolinyl, isoquinolinyl, imidazolyl, indolyl, isoindolyl, piperidinyl, pyrazolyl, 1,2,4-triazolyl, 1,2,3-triazolyl, tetrazolyl, thiazolyl, oxazolyl, pyrazinyl, and pyrimidinyl; and

25

30

R^{11e}, at each occurrence, is selected from C₁₋₆ alkyl, Cl, F, Br, I, CN, NO₂, (CF₂)_rCF₃, OH, and (CH₂)_rOC₁₋₅ alkyl;

R¹² is H;

35

alternatively, R¹¹ and R¹² join to form C₃₋₇ cycloalkyl;

- R¹⁴, at each occurrence, is selected from C₁₋₈ alkyl,
 (CH₂)_rC₃₋₆ cycloalkyl, CF₃, Cl, Br, I, F,
 (CH₂)_rNR^{14a}R^{14a'}, NO₂, CN, OH, (CH₂)_rOR^{14d},
 5 (CH₂)_rC(O)R^{14b}, (CH₂)_rC(O)NR^{14a}R^{14a'}, (CH₂)_rNR^{14f}C(O)R^{14b},
 (CH₂)_rS(O)_pR^{14b}, (CH₂)_rS(O)₂NR^{14a}R^{14a'},
 (CH₂)_rNR^{14f}S(O)₂R^{14b}, (CH₂)_rphenyl substituted with 0-3
 R^{14e};
- 10 R^{14a} and R^{14a'}, at each occurrence, are selected from H, C₁₋₆
 alkyl, C₃₋₆ cycloalkyl, and (CH₂)_rphenyl substituted
 with 0-3 R^{14e}, and a (CH₂)_r-5-6 membered heterocyclic
 system containing 1-4 heteroatoms selected from N, O,
 and S, substituted with 0-2 R^{15e};
- 15 R^{14b}, at each occurrence, is selected from H, C₁₋₆ alkyl,
 C₃₋₆ cycloalkyl, and (CH₂)_rphenyl substituted with 0-3
 R^{14e};
- 20 R^{14d}, at each occurrence, is selected from C₁₋₆ alkyl and
 phenyl;
- R^{14e}, at each occurrence, is selected from C₁₋₆ alkyl, Cl,
 F, Br, I, CN, NO₂, (CF₂)_rCF₃, OH, and (CH₂)_rOC₁₋₅ alkyl;
 25 and
- R^{14f}, at each occurrence, is selected from H, and C₁₋₅
 alkyl; and
- 30 r is selected from 0, 1, and 2.

35. The compound of claim 33, wherein:

- R⁵ is CH₂phenyl substituted with 0-3 R¹⁶;
- 35 R⁹, is selected from H, C₁₋₆ alkyl, (CH₂)_rC₃₋₆ cycloalkyl, F,
 Cl, CN, (CH₂)_rOH, (CH₂)_rOR^{9d}, (CH₂)_rNR^{9a}R^{9a'},

- (CH₂)_rOC(O)NHR^{9a}, (CH₂)_rphenyl substituted with 0-5 R^{9e}, and a heterocyclic system substituted with 0-2 R^{9e}, wherein the heterocyclic system is selected from pyridyl, thiophenyl, furanyl, oxazolyl, and thiazolyl;
- 5 R^{9a} and R^{9a'}, at each occurrence, are selected from H, C₁₋₆ alkyl, C₃₋₆ cycloalkyl, and (CH₂)_rphenyl substituted with 0-3 R^{9e};
- 10 R^{9d}, at each occurrence, is selected from C₁₋₆ alkyl and phenyl;
- R^{9e}, at each occurrence, is selected from C₁₋₆ alkyl, Cl, F, Br, I, CN, NO₂, (CF₂)_rCF₃, OH, and (CH₂)_rOC₁₋₅ alkyl;
- 15 R¹⁰ is selected from H, C₁₋₈ alkyl, OH, and CH₂OH;
- alternatively, R⁹ and R¹⁰ join to form C₃₋₇ cycloalkyl, 5-6-membered cyclic ketal or =O;
- 20 with the proviso that when R¹⁰ is -OH, R⁹ is not halogen, cyano, or bonded to the carbon to which it is attached through a heteroatom;
- 25 R¹¹ is selected from H, C₁₋₈ alkyl, (CH₂)_rphenyl substituted with 0-5 R^{11e}, and a (CH₂)_r-heterocyclic system substituted with 0-2 R^{11e}, wherein the heterocyclic system is selected from pyridinyl, thiophenyl, furanyl, indazolyl, benzothiazolyl, benzimidazolyl, benzothiophenyl, benzofuranyl, benzoxazolyl, benzisoxazolyl, quinolinyl, isoquinolinyl, imidazolyl, indolyl, isoindolyl, piperidinyl, pyrrazolyl, 1,2,4-triazolyl, 1,2,3-triazolyl, tetrazolyl, thiazolyl, oxazolyl, pyrazinyl, and pyrimidinyl; and
- 30 R^{11e}, at each occurrence, is selected from C₁₋₆ alkyl, Cl, F, Br, I, CN, NO₂, (CF₂)_rCF₃, OH, and (CH₂)_rOC₁₋₅ alkyl;
- 35

R¹² is H;

alternatively, R¹¹ and R¹² join to form C₃₋₇ cycloalkyl;

5

R¹⁴, at each occurrence, is selected from C₁₋₈ alkyl, (CH₂)_rC₃₋₆ cycloalkyl, CF₃, Cl, Br, I, F, (CH₂)_rNR^{14a}R^{14a'}, NO₂, CN, OH, (CH₂)_rOR^{14d}, (CH₂)_rC(O)R^{14b}, (CH₂)_rC(O)NR^{14a}R^{14a'}, (CH₂)_rNR^{14f}C(O)R^{14b},
10 (CH₂)_rS(O)_pR^{14b}, (CH₂)_rS(O)₂NR^{14a}R^{14a'}, (CH₂)_rNR^{14f}S(O)₂R^{14b}, (CH₂)_rphenyl substituted with 0-3 R^{14e}, and a (CH₂)_r-5-6 membered heterocyclic system containing 1-4 heteroatoms selected from N, O, and S, substituted with 0-2 R^{15e};

15

R^{14a} and R^{14a'}, at each occurrence, are selected from H, C₁₋₆ alkyl, C₃₋₆ cycloalkyl, and (CH₂)_rphenyl substituted with 0-3 R^{14e};

20

R^{14b}, at each occurrence, is selected from H, C₁₋₆ alkyl, C₃₋₆ cycloalkyl, and (CH₂)_rphenyl substituted with 0-3 R^{14e};

25

R^{14d}, at each occurrence, is selected from C₁₋₆ alkyl and phenyl;

R^{14e}, at each occurrence, is selected from C₁₋₆ alkyl, Cl, F, Br, I, CN, NO₂, (CF₂)_rCF₃, OH, and (CH₂)_rOC₁₋₅ alkyl;

30

R^{14f}, at each occurrence, is selected from H, and C₁₋₅ alkyl; and

r is selected from 0, 1, and 2.

35

36. The compound of claim 34, wherein:

J is selected from CH₂ and CHR⁵;

K is selected from CH₂ and CHR⁵;

L is selected from CH₂ and CHR⁵;

5

R³ is a C₃-10 carbocyclic residue substituted with 0-3 R¹⁵, wherein the carbocyclic residue is selected from cyclopropyl, cyclopentyl, cyclohexyl, phenyl, naphthyl and adamantyl, and a (CR³'H)_r-heterocyclic system substituted with 0-3 R¹⁵, wherein the heterocyclic system is selected from pyridinyl, thiophenyl, furanyl, indazolyl, benzothiazolyl, benzimidazolyl, benzothiophenyl, benzofuranyl, benzoxazolyl, benzisoxazolyl, quinolinyl, isoquinolinyl, imidazolyl, indolyl, indolinyl, isoindolyl, isothiadiazolyl, isoxazolyl, piperidinyl, pyrrazolyl, 1,2,4-triazolyl, 1,2,3-triazolyl, tetrazolyl, thiadiazolyl, thiazolyl, oxazolyl, pyrazinyl, and pyrimidinyl; and

10

15

20 R¹⁵, at each occurrence, is selected from C₁₋₈ alkyl, (CH₂)_rC₃₋₆ cycloalkyl, CF₃, Cl, Br, I, F, (CH₂)_rNR^{15a}R^{15a'}, NO₂, CN, OH, (CH₂)_rOR^{15d}, (CH₂)_rC(O)R^{15b}, (CH₂)_rC(O)NR^{15a}R^{15a'}, (CH₂)_rNR^{15f}C(O)R^{15b}, (CH₂)_rS(O)_pR^{15b}, (CH₂)_rS(O)₂NR^{15a}R^{15a'},
 25 (CH₂)_rNR^{15f}S(O)₂R^{15b}, (CH₂)_rphenyl substituted with 0-3 R^{15e}, and a (CH₂)_r-5-6 membered heterocyclic system containing 1-4 heteroatoms selected from N, O, and S, substituted with 0-2 R^{15e};

25

30 R^{15a} and R^{15a'}, at each occurrence, are selected from H, C₁₋₆ alkyl, C₃₋₆ cycloalkyl, and (CH₂)_rphenyl substituted with 0-3 R^{15e};

30

R^{15b}, at each occurrence, is selected from H, C₁₋₆ alkyl, C₃₋₆ cycloalkyl, and (CH₂)_rphenyl substituted with 0-3 R^{15e};

35

R^{15d}, at each occurrence, is selected from C₁₋₆ alkyl and phenyl;

5 R^{15e}, at each occurrence, is selected from C₁₋₆ alkyl, Cl, F, Br, I, CN, NO₂, (GF₂)_rCF₃, OH, and (CH₂)_rOC₁₋₅ alkyl; and

R^{15f}, at each occurrence, is selected from H, and C₁₋₅ alkyl.

10

37. The compound of claim 35, wherein:

K is selected from CH₂ and CHR⁵;

15 L is selected from CH₂ and CHR⁵;

R³ is a C₃₋₁₀ carbocyclic residue substituted with 0-3 R¹⁵, wherein the carbocyclic residue is selected from cyclopropyl, cyclopentyl, cyclohexyl, phenyl, naphthyl and adamantyl, and a (CR^{3'}H)_r-heterocyclic system substituted with 0-3 R¹⁵, wherein the heterocyclic system is selected from pyridinyl, thiophenyl, furanyl, indazolyl, benzothiazolyl, benzimidazolyl, benzothiophenyl, benzofuranyl, benzoxazolyl, 20 benzisoxazolyl, quinolinyl, isoquinolinyl, imidazolyl, indolyl, indolinyl, isoindolyl, isothiadiazolyl, isoxazolyl, piperidinyl, pyrazolyl, 1,2,4-triazolyl, 1,2,3-triazolyl, tetrazolyl, thiadiazolyl, thiazolyl, oxazolyl, pyrazinyl, and pyrimidinyl; and

30

R¹⁵, at each occurrence, is selected from C₁₋₈ alkyl, (CH₂)_rC₃₋₆ cycloalkyl, CF₃, Cl, Br, I, F, (CH₂)_rNR^{15a}R^{15a'}, NO₂, CN, OH, (CH₂)_rOR^{15d}, (CH₂)_rC(O)R^{15b}, (CH₂)_rC(O)NR^{15a}R^{15a'}, (CH₂)_rNR^{15f}C(O)R^{15b}, 35 (CH₂)_rS(O)_pR^{15b}, (CH₂)_rS(O)₂NR^{15a}R^{15a'}, (CH₂)_rNR^{15f}S(O)₂R^{15b}, and (CH₂)_rphenyl substituted with 0-3 R^{15e}, and a (CH₂)_r-5-6 membered heterocyclic system

containing 1-4 heteroatoms selected from N, O, and S,
substituted with 0-2 R^{15e};

5 R^{15a} and R^{15a'}, at each occurrence, are selected from H, C₁₋₆
alkyl, C₃₋₆ cycloalkyl, and (CH₂)_rphenyl substituted
with 0-3 R^{15e};

10 R^{15b}, at each occurrence, is selected from H, C₁₋₆ alkyl,
C₃₋₆ cycloalkyl, and (CH₂)_rphenyl substituted with 0-3
R^{15e};

R^{15d}, at each occurrence, is selected from C₁₋₆ alkyl and
phenyl;

15 R^{15e}, at each occurrence, is selected from C₁₋₆ alkyl, Cl,
F, Br, I, CN, NO₂, (CF₂)_rCF₃, OH, and (CH₂)_rOC₁₋₅ alkyl;
and

20 R^{15f}, at each occurrence, is selected from H and C₁₋₅ alkyl.

38. The compound of claim 29 and pharmaceutically
acceptable salt forms thereof, wherein the compound of
formula (I) is selected from

25 N"-cyano-N-(3-acetylphenyl)-N'-[(1R,2S)-2-[[3S)-3-(4-
fluorobenzyl)piperidinyl]methyl]cyclohexyl]guanidine,

30 N"-cyano-N-(4-((1H)-1-methyl-tetrazol-5-yl)phenyl)-N'-
[(1R,2S)-2-[[3S)-3-(4-
fluorobenzyl)piperidinyl]methyl]cyclohexyl]guanidine,

N"-cyano-N-(3-acetylphenyl)-N'-[(1R,2S)-2-[[4-(4-
fluorobenzyl)piperidinyl]methyl]cyclohexyl]guanidine,

35 N"-cyano-N-(phenyl)-N'-[(1R,2S)-2-[[4-(4-
fluorobenzyl)piperidinyl]methyl]cyclohexyl]guanidine,

- N"-cyano-N-(phenyl)-N'-[(1R,2S)-2-[[(3S)-3-(4-fluorobenzyl)piperidinyl]methyl]cyclohexyl]guanidine,
- 5 N"-cyano-N-(3-cyanophenyl)-N'-[(1R,2S)-2-[[(3S)-3-(4-fluorobenzyl)piperidinyl]methyl]cyclohexyl]guanidine,
- N"-cyano-N-(3-cyanophenyl)-N'-[(1R,2S)-2-[[4-(4-fluorobenzyl)piperidinyl]methyl]cyclohexyl]guanidine,
- 10 N"-cyano-N-(2,4-dimethoxyphenyl)-N'-[(1R,2S)-2-[[(3S)-3-(4-fluorobenzyl)piperidinyl]methyl]cyclohexyl]guanidine,
- N"-cyano-N-(2,5-dimethoxyphenyl)-N'-[(1R,2S)-2-[[(3S)-3-(4-fluorobenzyl)piperidinyl]methyl]cyclohexyl]guanidine,
- 15 N"-cyano-N-(4-((1H)-1-propyl-tetrazol-5-yl)phenyl)-N'-[(1R,2S)-2-[[(3S)-3-(4-fluorobenzyl)piperidinyl]methyl]cyclohexyl]guanidine,
- 20 N"-cyano-N-(1-adamantyl)-N'-[(1R,2S)-2-[[(3S)-3-(4-fluorobenzyl)piperidinyl]methyl]cyclohexyl]guanidine,
- N"-cyano-N-(2-adamantyl)-N'-[(1R,2S)-2-[[(3S)-3-(4-fluorobenzyl)piperidinyl]methyl]cyclohexyl]guanidine,
- 25 N"-cyano-N-(ethoxycarbonylmethyl)-N'-[(1R,2S)-2-[[(3S)-3-(4-fluorobenzyl)piperidinyl]methyl]cyclohexyl]guanidine,
- 30 N"-cyano-N-(5,6,7,8-tetrahydronaphth-1-yl)-N'-[(1R,2S)-2-[[(3S)-3-(4-fluorobenzyl)piperidinyl]methyl]cyclohexyl]guanidine,
- 35 N"-cyano-N-(2,4-dimethylphenyl)-N'-[(1R,2S)-2-[[(3S)-3-(4-fluorobenzyl)piperidinyl]methyl]cyclohexyl]guanidine,

- N"-cyano-N-(2-methoxyphenyl)-N'-[(1R,2S)-2-[[{(3S)-3-(4-fluorobenzyl)piperidinyl)methyl]cyclohexyl]guanidine,
- 5 N"-cyano-N-(2-methyl-4-hydroxyphenyl)-N'-[(1R,2S)-2-[[{(3S)-3-(4-fluorobenzyl)piperidinyl)methyl]cyclohexyl]guanidine,
- 10 N"-cyano-N-(2,5-dimethylphenyl)-N'-[(1R,2S)-2-[[{(3S)-3-(4-fluorobenzyl)piperidinyl)methyl]cyclohexyl]guanidine,
- N"-cyano-N-(2-phenylethyl)-N'-[(1R,2S)-2-[[{(3S)-3-(4-fluorobenzyl)piperidinyl)methyl]cyclohexyl]guanidine,
- 15 N"-cyano-N-(5-acetyl-2-methoxyphenyl)-N'-[(1R,2S)-2-[[{(3S)-3-(4-fluorobenzyl)piperidinyl)methyl]cyclohexyl]guanidine,
- 20 N"-cyano-N-[4-(4-morpholinyl)phenyl]-N'-[(1R,2S)-2-[[{(3S)-3-(4-fluorobenzyl)piperidinyl)methyl]cyclohexyl]guanidine,
- 25 2-[(3-acetylanilino)[((1R,2S)-2-[[{(3S)-3-(4-fluorobenzyl)piperidinyl)methyl]cyclohexyl]amino)methylene]malonitrile,
- 30 1-[3-((1-[[{(1R,2S)-2-[[{(3S)-3-(4-fluorobenzyl)piperidinyl)methyl]cyclohexyl]amino]-2-nitroethenyl)amino)phenyl]ethanone,
- 35 1-[3-((1-[(2-[[4-(4-fluorobenzyl)piperidinyl)methyl]phenyl]amino)-2-nitroethenyl]amino)phenyl]ethanone,

N"-cyano-N-(3,5-diacetylphenyl)-1-N'-[2-[[4-(4-fluorobenzyl)piperidinyl)methyl]3-(N-methylcarbamoyl)phenyl]guanidine,

5 N"-cyano-N-(3-diacetylphenyl)-1-N'-[2-[[4-(4-fluorobenzyl)piperidinyl)methyl]3-(N-methylcarbamoyl)phenyl]guanidine, and

10 N"-cyano-N-[3-[(1H)-1-methyltetrazol-5-yl]phenyl]-1-N'-[2-[[4-(4-fluorobenzyl)piperidinyl)methyl]3-(N-methylcarbamoyl)phenyl]guanidine.

39. A pharmaceutical composition, comprising a pharmaceutically acceptable carrier and a therapeutically effective amount of a compound claim 19-38.

40. A pharmaceutical composition, comprising a pharmaceutically acceptable carrier and a therapeutically effective amount of a compound claim 29.

20 41. A method for modulation of chemokine receptor activity comprising administering to a patient in need thereof a therapeutically effective amount of a compound of claim 19-38.

25 42. A method for modulation of chemokine receptor activity comprising administering to a patient in need thereof a therapeutically effective amount of a compound of claim 29.

30 43. A method for treating or preventing inflammatory diseases, comprising administering to a patient in need thereof a therapeutically effective amount of a compound of claim 19-38.

35 44. A method for treating or preventing inflammatory diseases, comprising administering to a patient in need

thereof a therapeutically effective amount of a compound of claim 29.

45. A method for treating or preventing asthma,
5 comprising administering to a patient in need thereof a therapeutically effective amount of a compound of claim 19-38.

46. A method for treating or preventing asthma,
10 comprising administering to a patient in need thereof a therapeutically effective amount of a compound of claim 29.

47. A method for treating or preventing disorders,
15 comprising administering to a patient in need thereof a therapeutically effective amount of a compound of claim 1-18, said disorders being selected from asthma, allergic rhinitis, atopic dermatitis, inflammatory bowel diseases, idiopathic pulmonary fibrosis, bullous pemphigoid, helminthic parasitic infections, allergic colitis, eczema,
20 conjunctivitis, transplantation, familial eosinophilia, eosinophilic cellulitis, eosinophilic pneumonias, eosinophilic fasciitis, eosinophilic gastroenteritis, drug induced eosinophilia, HIV infection, cystic fibrosis, Churg-Strauss syndrome, lymphoma, Igkin's disease, and
25 colonic carcinoma.

48. A method for treating or preventing disorders,
30 comprising administering to a patient in need thereof a therapeutically effective amount of a compound of claim 19-38, said disorders being selected from asthma, allergic rhinitis, atopic dermatitis, inflammatory bowel diseases, idiopathic pulmonary fibrosis, bullous pemphigoid, helminthic parasitic infections, allergic colitis, eczema, conjunctivitis, transplantation, familial eosinophilia,
35 eosinophilic cellulitis, eosinophilic pneumonias, eosinophilic fasciitis, eosinophilic gastroenteritis, drug induced eosinophilia, HIV infection, cystic fibrosis,

Churg-Strauss syndrome, lymphoma, Hodgkin's disease, and colonic carcinoma.

49. A method for treating or preventing disorders,
5 comprising administering to a patient in need thereof a
therapeutically effective amount of a compound of claim 29,
said disorders being selected from asthma, allergic
rhinitis, atopic dermatitis, inflammatory bowel diseases,
idiopathic pulmonary fibrosis, bullous pemphigoid,
10 helminthic parasitic infections, allergic colitis, eczema,
conjunctivitis, transplantation, familial eosinophilia,
eosinophilic cellulitis, eosinophilic pneumonias,
eosinophilic fasciitis, eosinophilic gastroenteritis, drug
induced eosinophilia, HIV infection, cystic fibrosis,
15 Churg-Strauss syndrome, lymphoma, Hodgkin's disease, and
colonic carcinoma.

INTERNATIONAL SEARCH REPORT

International application No.
PCT/US99/30332

A. CLASSIFICATION OF SUBJECT MATTER
 IPC(7) : Please See Extra Sheet.
 US CL : Please See Extra Sheet.
 According to International Patent Classification (IPC) or to both national classification and IPC

B. FIELDS SEARCHED
 Minimum documentation searched (classification system followed by classification symbols)
 U.S. : Please See Extra Sheet.

Documentation searched other than minimum documentation to the extent that such documents are included in the fields searched

Electronic data base consulted during the international search (name of data base and, where practicable, search terms used)
 CAS-structure
 EAST/WEST-chemokine, subclass search

C. DOCUMENTS CONSIDERED TO BE RELEVANT

Category*	Citation of document, with indication, where appropriate, of the relevant passages	Relevant to claim No.
A	US 3,988,294 A (HILL) 26 October 1976, see entire document.	1-40
A	WO 94/27991 A1 (NOVO NORDISK) 08 December 1994, see entire document.	1-40
A	JP 01-261383 A (NIPPON CHEMPHAR CO) 18 October 1989, see entire document.	1-40
Y	US 5,236,921 A (EMONDS-AI et al.) 17 August 1993, see entire document, especially columns 25-26, example 15.	1-49
Y	US 5,317,020 A (EMONDS-AI et al.) 31 May 1994, see entire document, especially columns 45-48 compounds.	1-49

Further documents are listed in the continuation of Box C. See patent family annex.

* Special categories of cited documents:	*T* later document published after the international filing date or priority date and not in conflict with the application but cited to understand the principle or theory underlying the invention
A document defining the general state of the art which is not considered to be of particular relevance	*X* document of particular relevance; the claimed invention cannot be considered novel or cannot be considered to involve an inventive step when the document is taken alone
B earlier document published on or after the international filing date	*Y* document of particular relevance; the claimed invention cannot be considered to involve an inventive step when the document is combined with one or more other such documents, such combination being obvious to a person skilled in the art
L document which may throw doubts on priority claim(s) or which is cited to establish the publication date of another citation or other special reason (as specified)	*A* document member of the same patent family
O document referring to an oral disclosure, use, exhibition or other means	
P document published prior to the international filing date but later than the priority date claimed	

Date of the actual completion of the international search 02 MARCH 2000	Date of mailing of the international search report 06 APR 2000
--	---

Name and mailing address of the ISA/US Commissioner of Patents and Trademarks Box PCT Washington, D.C. 20231 Facsimile No. (703) 305-3230	Authorized officer <i>Celia Chang</i> CELIA CHANG Telephone No. (703) 308-1235
---	---

INTERNATIONAL SEARCH REPORT

International application No.
PCT/US99/30332

C (Continuation). DOCUMENTS CONSIDERED TO BE RELEVANT		
Category*	Citation of document, with indication, where appropriate, of the relevant passages	Relevant to claim No.
Y	WO 97/19060 A1 (ZENECA LIMITED) 29 May 1997, see entire document, especially page 29, example 3.	1-49
Y	CASDATA--Chem. Abst. 123:133809, Kim et al. 'Migration and proliferation of guinea pig and human airway epithelial cells in response to tachykinins.' Am. J. Physiol. 1995 Vol. 269, pages L119-L126, see entire abstract.	41-49
Y	CASDATA--Chem. Abstr. 129:107602 Kraneveld et al. 'Airway hyperresponsiveness; first eosinophils and then neuropeptides.' Int. J. Immunopharm. 1997, Vol. 19(9/10), pages 517-527, see entire abstract.	41-49

INTERNATIONAL SEARCH REPORT

International application No.
PCT/US99/30332

A. CLASSIFICATION OF SUBJECT MATTER:

IPC (6):

IPC7 A61K 31/445; C07D 211/32, 211/52, 211/58, 211/62, 211/66, 211/76, 221/20, 401/04

A. CLASSIFICATION OF SUBJECT MATTER:

US CL :

514/278, 318, 319, 323, 324, 327, 329, 330, 331, 546/193, 194, 201, 207, 208, 209, 214, 217, 221, 225, 228, 229, 231, 233, 331

B. FIELDS SEARCHED

Minimum documentation searched

Classification System: U.S.

514/278, 318, 319, 323, 324, 327, 329, 330, 331, 546/193, 194, 201, 207, 208, 209, 214, 217, 221, 225, 228, 229, 231, 233, 331